

# MK-370 TILE SAW OWNERS MANUAL PARTS LIST & OPERATING INSTRUCTIONS



Revision 201	02.2017
Manual Part# 156760	

**Caution:** Read all safety and operating instructions before using this equipment. This parts list **MUST** accompany the equipment at all times.

## INTRODUCTION

Congratulations on your purchase of a MK-370 Saw. We are certain that you will be pleased with your purchase. MK Diamond takes pride in producing the finest construction power tools and diamond blades in the industry.

Operated correctly, your MK-370 Saw should provide you with years of service. In order to help you, we have included this manual. This owners manual contains information necessary to operate and maintain your MK-370 Saw safely and correctly. Please take the time to familiarize yourself with the MK-370 Saw by reading and reviewing this manual.

Read and follow all safety, operating and maintenance instructions.

If you should have questions concerning your MK-370 Saw, please feel free to call our friendly customer service department at: 800 421-5830

Regards,

MK Diamond

### NOTE THIS INFORMATION FOR FUTURE USE:

<b>MODEL NUMBER:</b>	
<b>SERIAL NUMBER:</b>	
<b>PURCHASE PLACE:</b>	
<b>PURCHASE DATE:</b>	

**NOTE:** For your (1) one year warranty to be effective, complete the warranty card (including the Serial Number) and mail it in as soon as possible.

## TABLE OF CONTENTS

### **SAFETY**

Safety Messages	4
Damage Prevention Message	4
General Safety Precautions	4
Rules for Safe Operation	4
California Proposition 65 Message	6
Hazard Symbols	7
Maintenance Safety	8
Electrical Requirements	8-10
Safety Label Locations	11
Product Specifications	12

### **UNPACKING, TRANSPORT and ASSEMBLY**

Unpacking	13
Contents	13
Transport	13

### **STARTUP, ADJUSTMENT, OPERATION and SHUTDOWN**

Cutting Head Installation	14
Diamond Blade Installation	14-15
Adjustable Cutting Guide Installation	16
Splash Guard Installation	16
Pre-Start Inspection	16
Water Pump Preparation	17
Setup for Operation	18
Adjustment & Operation	19
Cleanup	20
Lockout	21

### **MAINTENANCE AND TROUBLESHOOTING**

Maintenance	21
Blade Dressing	22
Motor Brush Change-Out	23
Troubleshooting	24-26

### **EXPLODED VIEW AND PARTS LIST**

Exploded View & Parts List	28-32
----------------------------	-------

### **THEORY**

Theory Of Diamond Blades	33
--------------------------	----

### **ACCESSORIES ORDERING and RETURN INSTRUCTIONS**



Accessories	34
Ordering Information	35
Return Material Policy	35
Packaging Instructions	35
Authorized Service Centers	35

Read and follow all safety, operating and maintenance instructions. Failure to read and follow these instructions could result in injury or death to you or others. Failure to read and follow these instructions could also result in damage and/or reduced equipment life.

## **SAFETY MESSAGES**

---

A safety message alerts you to potential hazards that could hurt you or others. Each safety message is preceded by a safety alert symbol (  ) and one of three words: **DANGER**, **WARNING**, or **CAUTION**.

-  **DANGER** You **WILL** be **KILLED** or **SERIOUSLY INJURED** if you do not follow directions.
-  **WARNING** You **CAN** be **KILLED** or **SERIOUSLY INJURED** if you do not follow directions.
-  **CAUTION** You **CAN** be **INJURED** if you do not follow directions. It may also be used to alert against unsafe practices.

## **DAMAGE PREVENTION AND INFORMATION MESSAGES:**

A Damage Prevention Message is to inform the user of important information and/or instructions that could lead to equipment or other property damage if not followed. Information Messages convey information that pertains to the equipment being used. Each message will be preceded by the word **NOTE**, as in the example below.

**NOTE:** Equipment and/or property damage may result if these instructions are not followed.

## **GENERAL SAFETY PRECAUTIONS AND HAZARD SYMBOLS**

In order to prevent injury, the following safety precautions and symbols should be followed at all times!

## **SAFETY PRECAUTIONS**

---



**ALWAYS** read this Owner's Manual before operating the machine.



**ALWAYS** keep the Blade Guards in place.



### **REMOVE ADJUSTING KEYS AND WRENCHES**

Form a habit of checking to see that keys and adjusting wrenches are removed from the power tool before it is turned on.



### **KEEP WORK AREA CLEAN**

Cluttered work areas and benches invite accidents.



### **DO NOT USE IN DANGEROUS PLACES**

**DO NOT** use power tools in damp or wet locations nor expose them to rain. Always keep the work area well lighted.



### **KEEP CHILDREN AWAY**

All visitors and children should be kept a safe distance from work area.

**MAKE THE WORKSHOP KID PROOF**

Make the workshops kid proof by using padlocks, master switches or by removing starter keys.

**DO NOT FORCE THE TOOL**

A power tool will do a job better and safer operating at the rate for which it was designed.

**USE THE RIGHT TOOL**

**DO NOT** force a tool or an attachment, to do a job that it was not designed to do.

**USE THE PROPER EXTENSION CORD**

If using an extension cord make sure it is in good condition first. When using an extension cord, be sure to use one heavy enough to carry the current your product will draw. An undersized cord will cause a drop in line voltage that will result in a loss of power and overheating. TABLE 1, Page 10 shows the correct AWG size to use depending on cord length and nameplate ampere rating. If in doubt, use the next heavier gage. The smaller the gage number, the heavier the cord.

**USE PROPER APPAREL**

**DO NOT** wear loose clothing, gloves, neckties, rings, bracelets, or other jewelry that may be caught in moving parts. Non-slip footwear is recommended. Wear protective hair covering to contain long hair.



**ALWAYS** wear approved eye protection.



**ALWAYS** wear approved respiratory protection.

**SECURE WORK**

Clamps or a vise should be used to hold work whenever practical. Keeping your hands free to operate a power tool is safer.

**DO NOT OVERREACH**

Keep proper footing and balance at all times by not overreaching.

**MAINTAIN TOOLS WITH CARE**

Keep tools clean for the best and safest performance. Always follow maintenance instructions for lubricating, and when changing accessories.

**DISCONNECT TOOLS**

Power tools should always be disconnected before servicing or when changing accessories, such as blades, bits, cutters, and the like.



**ALWAYS** place the power ON/OFF switch in the **OFF** position when the saw is not in use.

**USE RECOMMENDED ACCESSORIES**

Consult the owner's manual for recommended accessories. Using improper accessories may increase the risk of personal or by-stander injury.

**NEVER STAND ON THE TOOL**

Serious injury could occur if a power tool is tipped, or if a cutting tool is unintentionally contacted.

**CHECK FOR DAMAGED PARTS**

Before using a power tool, check for damaged part. A guard or any other part that is damaged should be carefully checked to determine if would operate properly and perform its intended function. Always check moving parts for proper alignment or binding. Check for broken parts and mountings and all other conditions that may affect the operation of the power tool. A guard, or any damaged part, should be properly repaired or replaced.

**DIRECTION OF FEED**

**ALWAYS** feed work into a blade or cutter against the direction of rotation. A blade or cutter should always be installed such that rotation is in the direction of the arrow imprinted on the side of the blade or cutter.

**NEVER LEAVE A TOOL UNATTENDED**

**TURN POWER OFF** - Do not leave a tool until it comes to a complete stop. Always turn a power tool OFF when leaving the work area, or, when a cut is finished.

---

**CALIFORNIA PROPOSITION 65 MESSAGE****WARNING**

Some dust created by power sanding, sawing, grinding, drilling, and other construction activities contain chemicals known [to the State of California] to cause cancer, birth defects or other reproductive harm. Some examples of these chemicals are:

- Lead, from lead-based paints
- Crystalline silica, from bricks and cement and other masonry products and
- Arsenic and chromium, from chemically treated lumber

For further information, consult the following sources:

<http://www.osha.gov/SLTC/silicacrystalline/index.html>

[http://www.oehha.org/prop65/out\\_of\\_date/6022kLstA.html](http://www.oehha.org/prop65/out_of_date/6022kLstA.html)

Your risk from these exposures varies depending on how often you do this type of work. To reduce your exposure to these chemicals, work in a well-ventilated area, and work with approved safety equipment, such as those dust masks that are specially designed to filter out microscopic particles.

**HAZARD SYMBOLS**

---

**ELECTRICAL SHOCK**

**NEVER** touch electrical wires or components while the engine is running. They can be sources of electrical shock which could cause severe injury or burns.

**ROTATING PARTS**

Keep hands, feet, hair, and clothing away from all moving parts to prevent injury. Never operate the motor with covers, shrouds, or guards removed.

**OVER SPEED**

**NEVER** tamper with the governor components or settings to increase the maximum speed. Severe personal injury and damage to the engine or equipment can result if operated at speeds above maximum.

**DO NOT EXPOSE TO RAIN**

**DO NOT** expose to rain or use in damp locations.

**WARNING**

Sawing and drilling generates dust. Excessive airborne particles may cause irritation to eyes, skin and respiratory tract. To avoid breathing impairment, always employ dust controls and protection suitable to the material being sawed or drilled; See OSHA (29 CFR Part 1910.1200). Diamond Blades improperly used are dangerous. Comply with American National Standards Institute Safety Code, B7.1 and, Occupational Safety and Health Act covering Speed, Safety Guards, Flanges, Mounting Procedures, General Operating Rules, Handling, Storage and General Machine Conditions

## ELECTRICAL REQUIREMENTS AND GROUNDING INSTRUCTIONS

In order to prevent potential electrical shock and injury, the following electrical safety precautions and symbols should be followed at all times!



### WARNING

In case of a malfunction or breakdown, grounding provides a path of least resistance for electric current to reduce the risk of electric shock. This tool is equipped with an electric cord having an equipment-grounding conductor and a grounding plug. The plug must be plugged into a matching outlet that is properly installed and grounded in accordance with all local codes and ordinances.

- Do not modify the plug provided – if it will not fit the outlet; have the proper outlet installed by a qualified electrician
- Improper connections of the equipment-grounding conductor can result in a risk of electric shock. The equipment-grounding conductor is the insulated conductor that has an outer surface that is green, with or without yellow stripes. If repair or replacement of the electric cord or plug is necessary, do not connect the equipment-grounding conductor to a live terminal
- Check with a qualified electrician or service personnel if the grounding instructions are not completely understood, or if in doubt as to whether the tool is properly grounded
- Use only 3-wire extension cords that have 3-prong grounding plugs and 3-pole receptacles that accept the tool's plug
- Repair or replace a damaged or worn cord immediately



### WARNING

This tool is intended for use on a circuit that has an outlet that looks like the one shown in Sketch A. The tool has a grounding plug that looks like the plug illustrated in Sketch A. A temporary adapter, which looks like the adapter illustrated in sketches B and C, may be used to connect this plug to a 2-pole receptacle as shown in Sketch B, if a properly grounded outlet is not available. The temporary adapter should be used only until a properly grounded outlet can be installed by a qualified electrician. The green-colored rigid ear, lug, and the like, extending from the adapter, must be connected to a permanent ground such as a properly grounded outlet box.

NOTE: Use of a temporary adapter is not permitted in Canada.

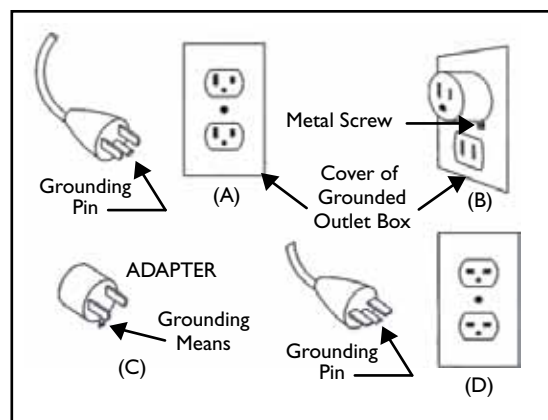

Circuit and Adapter Information



**WARNING**

To avoid the possibility of the appliance plug or receptacle getting wet, position the machine to one side of a wall mounted receptacle. This will prevent water from dripping onto the receptacle or plug. A “drip loop,” shown in the picture below, should be arranged by the user to properly position the power cord relative to the power source.

The “drip loop” is that part of the cord below the level of the receptacle, or the connector, if an extension cord is used. This method of positioning the cord prevents the travel of water along the power cord and coming in contact with the receptacle.

If the plug or receptacle gets wet, **DO NOT** unplug the cord. Disconnect the fuse or circuit breaker that supplies power to the tool. Then unplug and examine for presence of water in the receptacle.

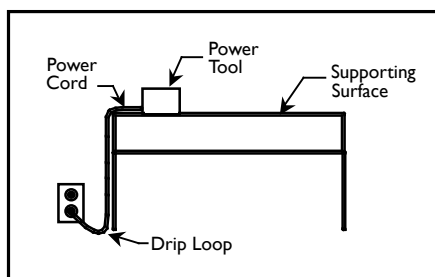

**Drip Loop Information**

**WARNING**

Use only extension cords that are intended for outdoor use. These extension cords are identified by a marking “Acceptable for use with outdoor appliances; store indoors while not in use.” Use only extension cords having an electrical rating not less than the rating of the product. Do not use damaged extension cords. Examine extension cords before using and replace if damaged. Do not abuse extension cords and do not yank on any cord to disconnect. Keep cords away from heat and sharp edges. Always disconnect the extension cord from the receptacle before disconnecting the product from the extension cord.



**WARNING**



To reduce the risk of electrocution, keep all connections dry and off the ground. Do not touch the plug with wet hands.



**WARNING**

Use of under sized extension cords result in low voltage to the motor that can result in motor burnout and premature failure. MK Diamond warns that equipment returned to us showing signs of being run in a low voltage condition, through the use of undersized extension cords will be repaired or replaced totally at the customer's expense. There will be no warranty claim.

To choose the proper extension cord,

- Locate the length of extension cord needed in the table below.
- Once the proper length is found, move down the column to obtain the correct AWG size required for that length of extension cord.

EXTENSION CORD MINIMUM GAGE FOR LENGTH				
VOLTS	TOTAL LENGTH OF CORD IN FEET			
	25 ft. AWG	50 ft. AWG	100 ft. AWG	150 ft. AWG
115v	14	12	Not Recommended	Not Recommended
230v	N/A	14	12	N/A

**SAFETY LABEL LOCATIONS**

Safety labels contain important safety information. Please read the information contained on each safety label. These labels are considered a permanent part of your saw. If a label comes off or becomes hard to read, contact MK Diamond or your dealer for a replacement.

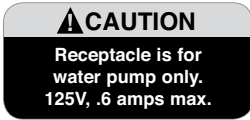

Label A



Label B



Label C

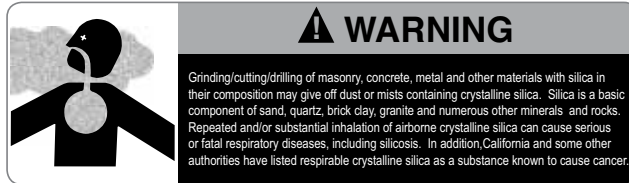

Label D



Label E

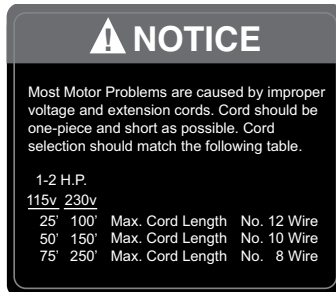

Label F

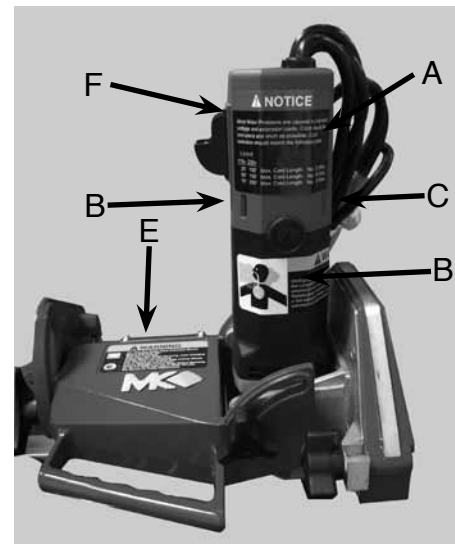

Tile Master Label Sheet Part#166012

Decal/Label	Location	Description
A	Motor - Side	Caution - Receptacle is for Water Pump Only
B	Motor - Side	Caution - Use with GFCI outlet only
C	Motor - Back	Service/ Warranty
D	Motor - Front	Warning - Silica Warning
E	Cutting Head – Top	Warning - Read Owners Manual
F	Motor - Front	Notice - Voltage/extension cords

**TILE SAW SPECIFIC WARNINGS**

**! WARNING**

- Wear eye protection.
- Use splash guard for every operation for which it can be used.
- Disconnect saw before servicing, when changing cutting blades, and cleaning.
- Replace damaged cutting blade before operating.

## **PRODUCT SPECIFICATIONS**

---

The MK-370 is a versatile Tile Saw. Operated and used according to this manual, the MK-370 will provide years of dependable service.

## **GENERAL DESCRIPTION**

---

The MK-370 Tile Saw is engineered as a tabletop wet tile saw. The saw includes a powerful 120V electric motor. The saw is capable of cutting tile up to fourteen (14) inches in length. The saw can cut an object two (2) inches thick in one pass.

## **MOTOR SPECIFICATIONS**

---

Motor specifications for the MK-370 are listed in the table below.

Voltage	120v
Overall Amperage	7.4 A
Frequency	50/60Hz
RPM	6000 rpm
Horse Power	1-1/4 hp

## **BLADE CAPACITY**

---

The MK-370 uses a seven (7) inch (178mm) diameter, wet cutting continuous rim, MK Diamond blade with a five-eighths (5/8) inch (15.875 mm) arbor.

## **TILE TYPES**

---

The MK-370 can cut a variety of tile types including stone, ceramic, slate, granite, marble, porcelain, and lapidary products.

**NOTE:** The MK-370 is not designed to cut plastic or metals.

**UNPACKING**

**CAUTION** Use proper lifting techniques when lifting the MK-370 Saw.

Remove the MK-370 and accessory box from the carton.

**CONTENTS**

One (1) MK-370 cutting surface & water pan  
 One (1) MK-370 cutting head  
 One (1) 7-inch wet cutting blade  
 One (1) splash guard  
 One (1) splash guard wing nut & washer

One (1) extended rip guide  
 One (1) electric water pump  
 One (1) cooling transfer tube  
 One (1) flow adjusting clamp  
 One (1) blade wrench  
 One (1) shaft wrench,  
 One (1) owners manual

One (1) pump manual  
 One (1) warranty card



MK-370 Cutting Surface



MK-370 Cutting Head



Diamond Blade

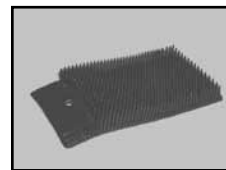

Splash Guard



Splash Guard Wing Nut & Washer



Rip Guide



Electric Water Pump



Cooling Transfer Tube



Flow Adjusting Clamp



Blade Nut Wrench



Shaft Wrench



Owners Manual

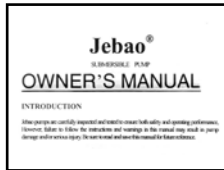

Pump Manual



Warranty Card

**TRANSPORT**

**CAUTION**

1. The MK-370 Saw weighs approximately thirty (30) pounds; use care when transporting.
2. Never transport the MK-370 Saw with water in the Water Pan.

The MK-370 Saw is designed with a rigid frame and removable Cutting Head making the saw easily transportable. To lift the saw, grasp the front and back of the frame at the lift points shown below.



Follow the assembly instructions to prepare your MK-370 for operation.

**CUTTING HEAD INSTALLATION**

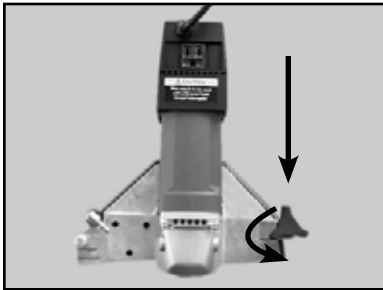

(A)  
Loosen the Blade Guard Retaining Knob

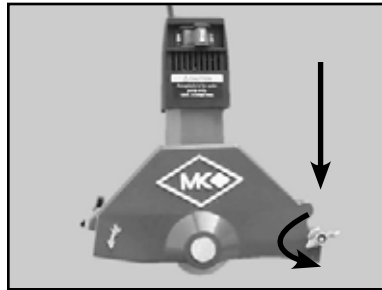

(B)  
Remove the Blade Guard Wingnut and then remove the Blade Guard

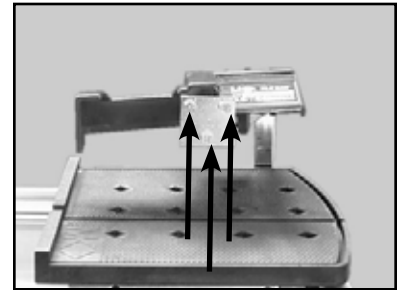

(C)  
Locate and remove the three Cutting Head Retaining Screws using a Phillips Screwdriver

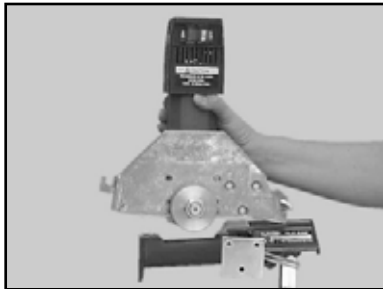

(D)  
Align the Cutting Head Retaining Holes to the holes on the Post

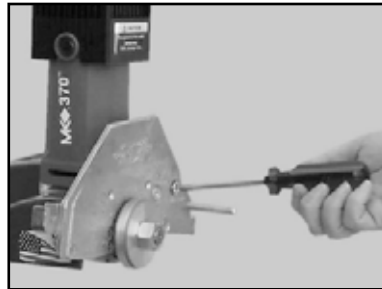

(E)  
Install the three Cutting Head Retaining Screws using a Phillips Screwdriver

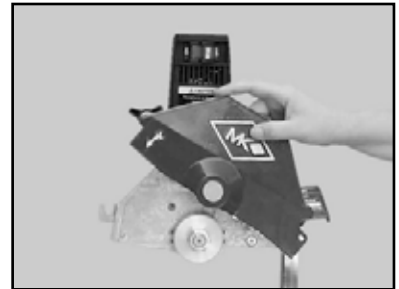

(F)  
Install the Blade Guard and tighten Wingnut and Retaining Knob

**DIAMOND BLADE INSTALLATION**

**NOTE:** When installing the Retaining Screw, do not "cross-thread" and DO NOT over tighten the screw.



(A)  
Loosen the Blade Guard Retaining Wingnut



(B)  
Loosen the Blade Guard Retaining Knob and open the Blade Guard



(C)  
Place the Shaft Wrench on the Motor Shaft (NOTE: the Outer and Inner Flanges and the Blade Nut are removed in the photo above) rotate blade shaft so shaft wrench is engaged.

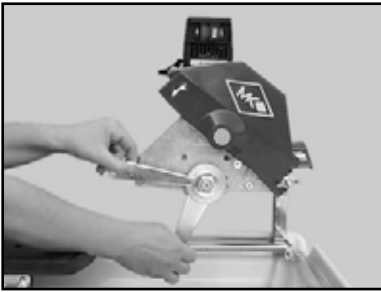

(D)

Place the Blade Wrench on the Blade Retaining Nut and remove the Blade Retaining Nut and Outer Flange

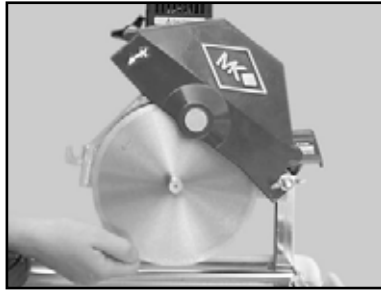

(E)

Install Diamond Blade onto Blade Shaft

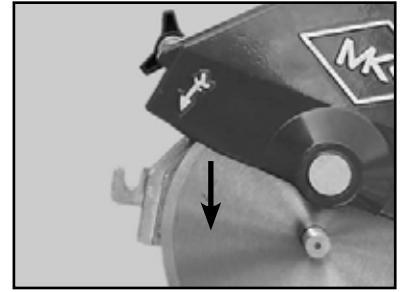

(F)

Verify the Directional Arrow of the Blade faces outward and matches the Directional Arrow of the Blade Guard



(G)

Install the Outer Flange and Retaining Nut; install the Shaft Wrench and Blade Wrench as shown in Steps C and D and tighten the Retaining Nut



(H)

Close the Blade Guard and tighten the Blade Guard Retaining Knob



(I)

Tighten the Blade Guard Retaining Wingnut

**ADJUSTABLE CUTTING GUIDE INSTALLATION**

**NOTE:** The Adjustable Cutting Guide can be used on either side of the Diamond Blade.

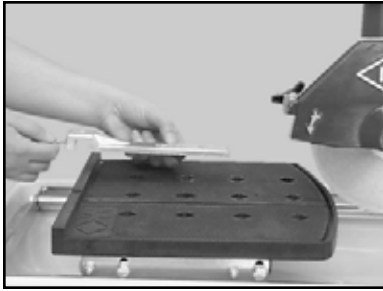

(A)  
Loosen Adjustable Cutting Guide retaining thumbscrew and place it over the Movable Cutting Table and Ruler/Stop

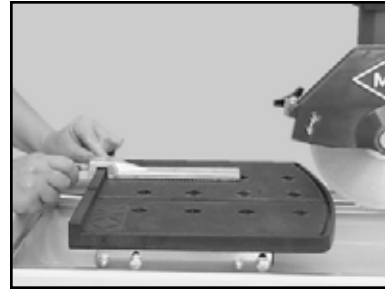

(B)  
Place the Adjustable Cutting Guide onto the Ruler/Stop and tighten the retaining thumbscrew

**SPLASH GUARD INSTALLATION**

(A)  
Remove Thumbscrew and washer from back of Blade Guard



(B)  
Install the Thumbscrew through the Washer and Splashguard then align to the hole found on back of the Blade Guard and tighten

**PRE-START INSPECTION**

Prior to beginning work, a pre-start inspection of the saw should be performed.



(A)  
Ensure the ON/OFF Switch is in the OFF position



(B)  
Inspect the Pump Assembly for damage - ensure the cord is free of cracks or cuts



(C)  
Inspect the Diamond Blade for damage – verify the blade is correct for the type of material being cut



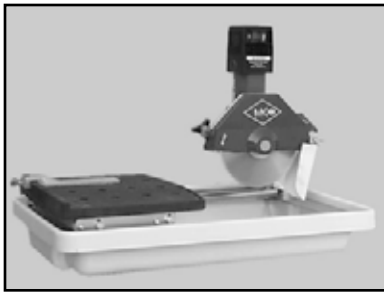

(D)

Inspect the MK-370 for damage – ensure the cord is free of cracks or cuts

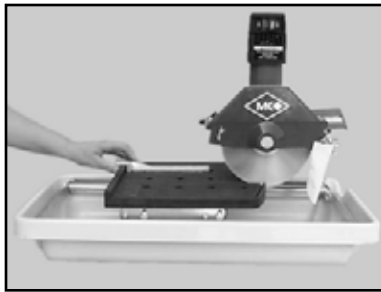

(E)

Verify the Movable Cutting Table moves freely

**WATER PUMP PREPARATION**

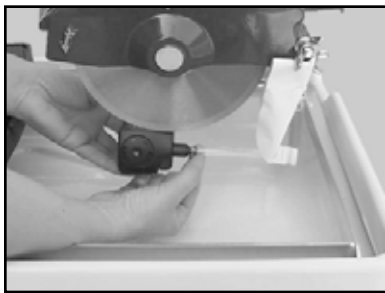

(A)

Press the end of the cooling Transfer Tube onto the Water Pump



(B)

Connect the Cooling Transfer Tube to the inlet connection of the Blade Guard

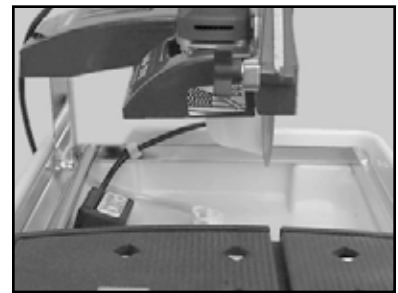

(C)

Place the Water Pump in the Water Pan with the suction down and insert the Pump Cord to the clip in the back.



(D)

Fill the water Pan with clean water covering Pump suction (this should be done periodically during cutting)



(E)

Connect the Water Pump power cord to the connection found on the back of the motor

**SETUP FOR OPERATION**

---

**CAUTION**

1. Before connecting the MK-370 Saw to a power supply, be sure the voltage, cycle and phase meet the requirements of table below.
2. If using an extension cord, make sure the length and wire gauge correspond to the requirements listed in the table on page 16. An extension cord that is too small in wire gauge (diameter), or too long in length, will cause the motor to overheat and could cause premature failure.
3. Before connecting the MK-370 Saw to a power supply, be sure the voltage, cycle and phase of the job site power source meet the requirements in the table below.
4. Plug the MK-370 Saw into a wall outlet with built-in GFCI protection.
5. Do not cover the motor vents as this could lead to motor overheating.

VOLTAGE	120v
CYCLE	60Hz
PHASE	1-phase

**ADJUSTMENT & OPERATION**

**⚠ CAUTION** DO NOT FORCE THE TOOL. It will do the job better and safer at the rate for which it was designed.

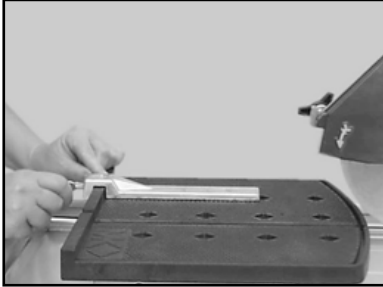

(A)

Loosen the retaining thumbscrew and place the Adjustable Cutting Guide to the desired cut length and tighten thumbscrew



(B)

Place the tile against the Ruler/Stop and Cutting Guide



(C)

Turn the motor ON and verify proper cooling flow on both sides of the blade (See Maintenance Section to increase/decrease flow)

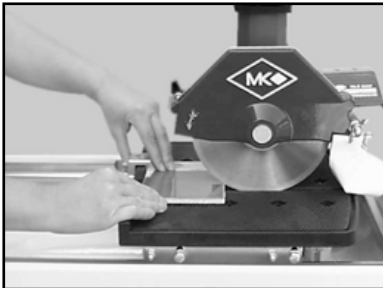

(D)

Perform the cut. Turn the motor OFF when work is complete

**CLEANUP**

**NOTE:** Dispose of wastewater in accordance with applicable Federal, State and Local laws.



(A)

Ensure the ON/OFF Switch is in the OFF position. Remove the Cutting Assembly from the Water Pan



(B)

Dispose of the contents of the Water Pan and clean the pan. Replace the Cutting Assembly.



(C)

Clean the Water Pump of all debris. (Refer to water pump manual for more detail)



**CAUTION**

Ensure the saw is disconnected before completing the remainder of the cleanup process.

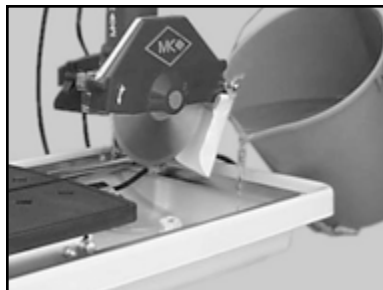

(D)

Fill the Water Pan with clean water

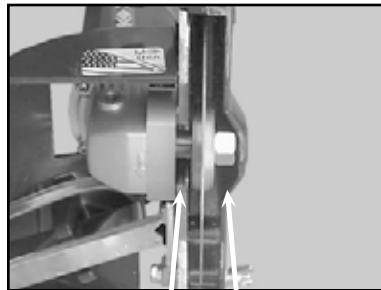

(E)

Run the MK-370 until clear water is seen at the blade cooling ports (Approx. 1 minute)



(F)

Dispose of the contents of the Water Pan and clean the MK-370 with soap and clear water



**CAUTION**

To extend the life of the MK370, lubricate the Motor Shaft with light oils such as, 3 in 1, WD-40, etc.



(G)

Clean the Guide Bar



(H)

Clean the Roller Wheel Guide Rail

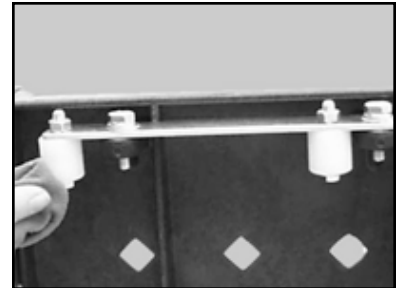

(I)

Clean the Roller Wheels



**CAUTION**

To extend the life of the MK-370 Saw, the following procedure should be performed after each use. Lubricate all points listed below with MK Linear Guide Bar Lubricant, 3-IN-ONE oil, or other multipurpose spray lubricant.

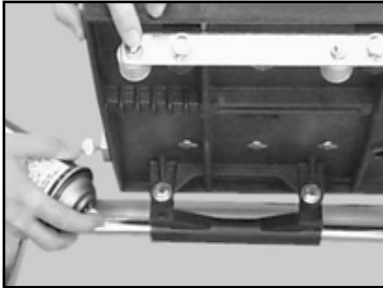

(J)  
Lubricate the Guide Bar

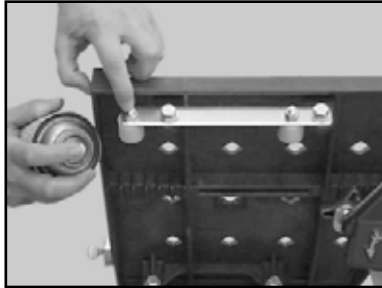

(K)  
Lubricate the Roller Wheel Assembly

**LOCKOUT**

The MK-370 Saw is equipped with a lockout device that can be used during maintenance and troubleshooting to render the saw inoperable. The lockout can also be used to prevent unauthorized use.



(A)  
Locate the Lockout Pin in the center of the ON/OFF Switch toggle (the Lockout Pin has "Remove To Lock" highlighted)



(B)  
Lockout the Saw by removing the Pin

**MAINTENANCE**

**Monthly Maintenance**

The following maintenance should be performed monthly.



(A)  
Remove and clean the Inner and Outer Flanges and the Blade Retaining Nut

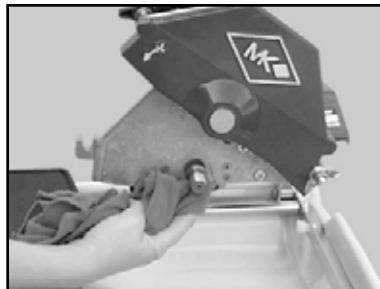

(B)  
Clean the Motor Shaft

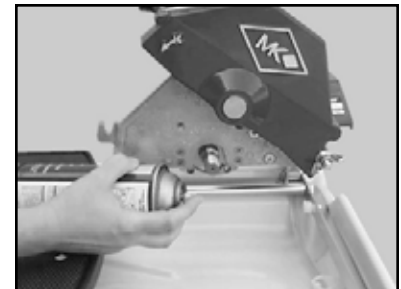

(C)  
Lubricate the Motor Shaft

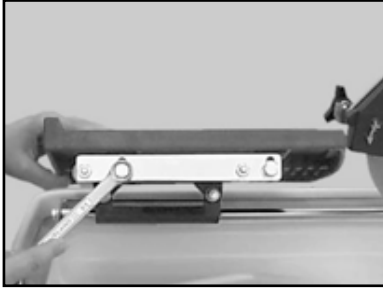

(D)

Verify the Movable Cutting Table Roller Wheel Assembly is tight



(E)

Verify the Roller Wheels are tight



(F)

Verify the Cutting Head Assembly Retaining Screws are tight

**BLADE DRESSING**

Like most cutting instruments, a diamond blade performs best when it is dressed. Over time and use, diamonds on the outer edge of the blade will become smoothed or "glazed" over. This will reduce grinding efficiency and may cause the blade to "wander" or bend giving the illusion of an alignment problem. When this occurs, the blade will need to be dressed. The diamond blade can be dressed using the MK Dressing Stick (part# 152972) and by following the steps below.

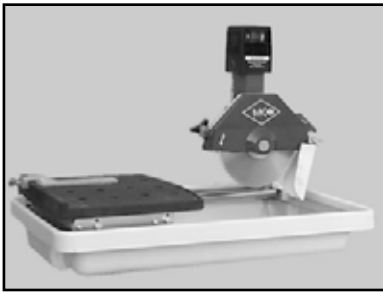

(A)

Setup the MK-370 Saw for operation (See Setup, Adjustment and Operation)

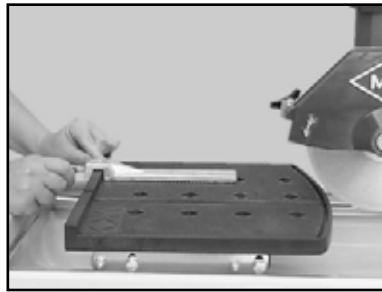

(B)

Set the Adjustable Cutting Guide to cut a 1/16-strip

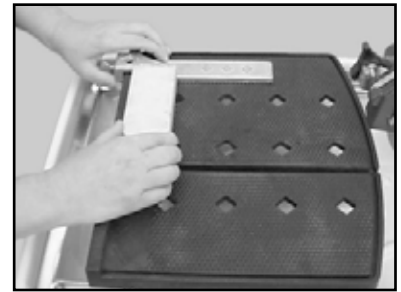

(C)

Position the Dressing Stick against the Adjustable Cutting Guide and the Ruler/Stop

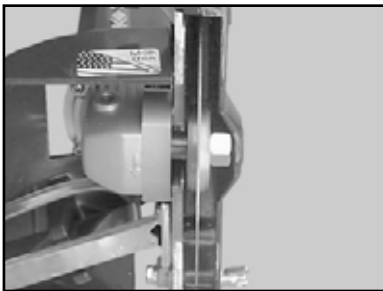

(D)

Turn the motor ON. Verify proper cooling flow on both sides of the blade

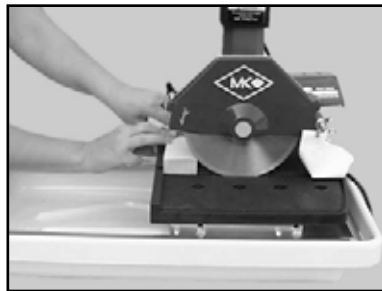

(E)

Push the Dressing Stick into the Blade in a smooth even motion to perform a cut, repeat 7 or 8 times to dress the Blade

**MOTOR BRUSH CHANGE-OUT****WARNING**

Disconnect the tool before servicing and when changing accessories, such as blades and bits.



(A)

Locate and loosen one Motor Brush Housing Cover using a Flat Head Screwdriver



(B)

Remove the Motor Brush Housing Cover



(C)

Remove the old Motor Brush



(D)

Clean the Motor Brush Housing using a Q-tip



(E)

Align and install the new Motor Brush



(F)

Install Motor Brush Cap and tighten using a screwdriver



(G)

Install the second Motor Brush (Repeat Steps C to F)

**TROUBLESHOOTING**

Blade will not cut properly.



(A)

Check for Smoothness or "Glazing" (Dress blade if needed)

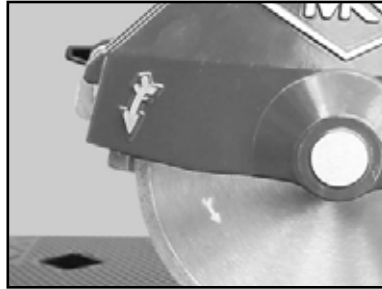

(B)

Check for proper rotation



(C)

Ensure the Blade Core is not bent and Arbor is not out of round



(D)

Verify the blade is correct for the material being used

**COOLING FLOW**

(A)

Check that the Cooling Flow Adjusting Valve is FULL open



(B)

Remove the Cooling Transfer Tube from the Blade Guard inlet and clean

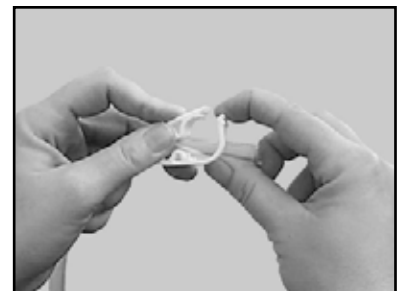

(C)

Check the cooling flow Adjusting Clamp is open



**NOTE:** "Rodding" cooling channels is performed by inserting a small wire rod through the cooling inlet on top of the Blade Guard and directing the rod out through each of the cooling flow tubes located on the underside of the Blade Guard. The cooling channels should be "rodded" until all ports are free of foreign debris.



(D)  
Remove the Blade Guard Intake Fitting

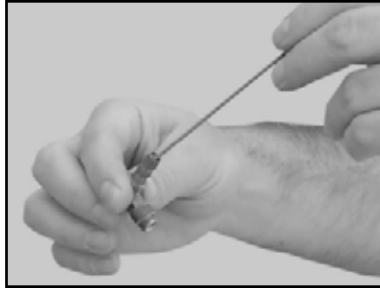

(E)  
Clean the Blade Guard Intake Fitting

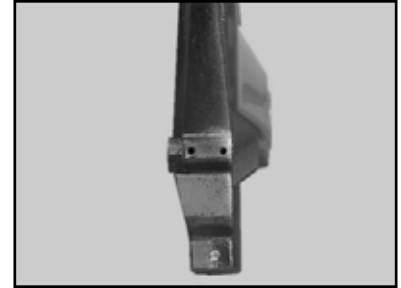

(F)  
Locate the Blade Guard Cooling Channels



(G)  
Rod Cooling Channels and recheck flow

## **MOVABLE CUTTING TABLE DOES NOT MOVE CORRECTLY**

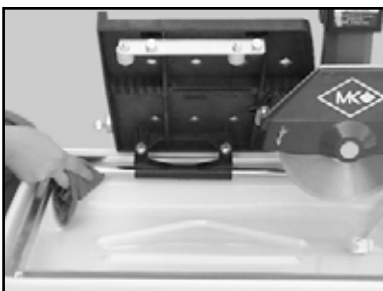

(A)  
Check the Guide Bar and Roller Wheel Guide Frame is clean - clean if dirty



(B)  
Check the Movable Cutting Table Roller Wheels for wear replace if necessary

**BLADE STOPS TURNING**

(A)

Check the ON/OFF Switch is in the ON position

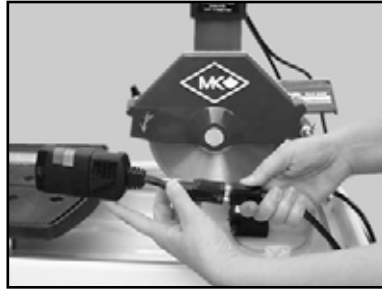

(B)

Verify all plugs are fully connected.  
Check to see if the wall outlet Ground Fault Circuit Interrupter (GFCI) is tripped.

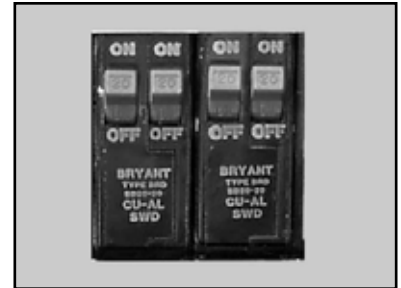

(C)

Verify circuit breaker not tripped; if it is tripped, reset it once only



(D)

Check power source voltage is 120v - if not 120v, move to another circuit



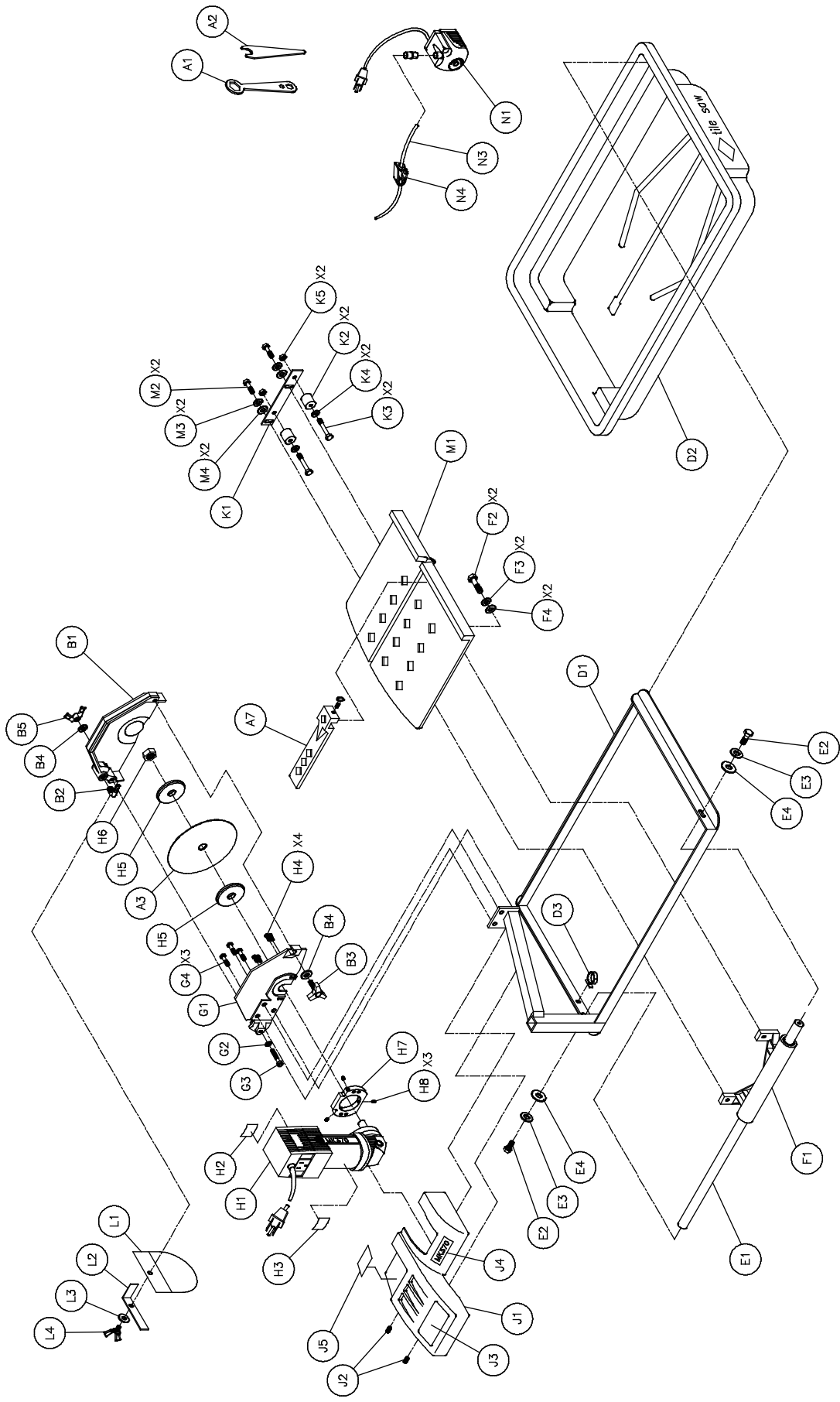

ITEM	DESCRIPTION	PART #	QTY
<b>A</b>	<b>Accessories</b>	<b>n/a</b>	<b>-</b>
A1	Wrench, Blade Nut, 15/16 Boxed End	134684	1
A2	Wrench, Blade Shaft, 11/16 Open End	153450	1
A3	Blade, 7 Dia X 5/8 arbor	153441	1
A4	Owner's Manual, 370	156760	1
A5	Warranty Card	155037	1
A6	Tag, Saw Hang, 370	156750	1
A7	Assembly, Rip Guide	134551-MK	1
<b>B</b>	<b>Assembly, Blade Guard, 7"</b>	<b>154811-MK</b>	<b>1</b>
B1	Guard, 7" Blade	154811	1
B2	Elbow, 1/8 MNPT X 1/4 BARB 90° Brass	154652	1
B3	Knob, Davies	151681	1
B4	Washer, 5/16 SAE Flat	151754	2
B5	Wingnut, 5/16-18 Nylock	151746	1
<b>D</b>	<b>Frames</b>	<b>n/a</b>	<b>-</b>
D1	Frame	155792	1
D2	Pan, Water	155791	1
D2A	Pan, Water, Deep	157210	1
D3	Cord Clip, 1/4 Push Mount	157259	1
<b>E</b>	<b>Assembly, 5/8 Guide Bar</b>	<b>151739-MK</b>	<b>1</b>
E1	Bar, Guide, 5/8 Dia	151739	1
E1A	Bar, Guide, 5/8 Dia, Extended	157486	1
E2	Screw, 5/16-18 X 1 Hex Head Cap	151743	2
E3	Washer, 5/16 Split Lock	151747	2
E4	Washer, 5/16 SAE Flat	151754	2
<b>F</b>	<b>Linear Bearing</b>	<b>n/a</b>	<b>-</b>
F1	Bearing, Linear, 5/8 Dia (comp)	157126	1
	F1A Bearing, Multilube	151781	2
F2	Screw, 5/16-18 X 1 Hex Head Cap	151743	2
F3	Washer, 5/16 Split Lock	151747	2
F4	Washer, 5/16 SAE Flat	151754	2
<b>G</b>	<b>Assembly, Motor Mount</b>	<b>155811-MK</b>	<b>1</b>
G1	Motor Mount	157403	1
G2	Washer, 5/16 Split Lock	151747	1
G3	Screw, 5/16-18 X 2 1/2 Hex Head Cap, Full Thread	151748	1
G4	Screw, 1/4-20 X 1/2 Flat Head Phillips Cap	155812	3
<b>H</b>	<b>Motors</b>	<b>n/a</b>	<b>-</b>
H1	Motor, 120v/7.4a, 370	156428-R	1
H2	Label, Caution, GFCI, 1 X 2 1/8	155678	1
H3	Label, Caution, Receptacle, 1 X 2 1/8	154822	1
H4	Screw, 10-32 X 5/8 Flat Head Phillips Cap,	157554	4
H5	Flange, Blade	135830	2
H6	Nut, 5/8-18 UNF	135848	1
H7	Adapter, Motor, 370	156703	1
H8	Screw, 10-32 X 1/4 Socket Head Set, Cup Point	156715	3

ITEM	DESCRIPTION	PART #	QTY
H9	Label, 370 Model	156692	1
H10	Plug, CEE 7/7 16a 240v	153687	1
<b>J</b>	<b>Post Cover</b>	<b>n/a</b>	<b>-</b>
J1	Casting, Cover, Post, 370	156748	1
J2	Screw, 10-24 X 3/8 Socket Head Set, Cup Point	156715	2
J3	Label, Warning, Read Owner's Manual	155806	1
J4	Label, 370 Model	156692	1
J5	Label, Serial Number, UL/CSA Mark	157249-04	1
<b>K</b>	<b>Assembly, Roller Wheel, Double</b>	<b>156586</b>	<b>1</b>
K1	Bracket, Roller Wheel	156522	1
K2	Wheel, Roller	151799	2
K3	Screw, 1/4-20 X 1 1/2 Hex Head Cap	151914	2
K4	Washer, 1/4 SAE Flat	151915	2
K5	Nut, 1/4-20 Hex	151893	2
<b>L</b>	<b>Assembly, Splash Curtain</b>	<b>155901-MK</b>	<b>1</b>
L1	Curtain, Splash	134841	1
L2	Bracket, Splash Curtain	155901	1
L3	Washer, 1/4 SAE Flat	151915	1
L4	Wingscrew, 1/4-20 X 1/2	151888	1
<b>M</b>	<b>Table</b>	<b>n/a</b>	<b>-</b>
M1	Table, Composite, 370/470	156536	1
M2	Screw, 5/16-18 X 1 Hex Head Cap	151743	2
M3	Washer, 5/16 Split Lock	151747	2
M4	Washer, 5/16 SAE Flat	151754	2
<b>N</b>	<b>Assembly, PES-100 120v Water Pump</b>	<b>155987-MK</b>	<b>1</b>
N1	Pump, Water, PES-100 120v	155987	1
N1A	Pump, Water, 100v	154812	1
N1B	Pump, Water, 230v	156181	1
N3	Hose, Vinyl, 1/4 ID	132951	2'
N4	Clamp, Flow, 1/4-1/2	154394	1
N5	Owner's Manual, Water Pump	155745	1

## THEORY OF DIAMOND BLADES

---

Diamond blades do not really cut; they grind the material through friction. Diamond crystals, often visible at the leading edge and sides of the rim/segment, remove material by scratching out particles of hard, dense materials, or by knocking out larger particles of loosely bonded abrasive material. This process eventually cracks or fractures the diamond particle, breaking it down into smaller pieces. As a result, a diamond blade for cutting soft, abrasive material must have a hard metal matrix composition to resist this erosion long enough for the exposed diamonds to be properly utilized. Conversely, a blade for cutting a hard, non-abrasive material must have a soft bond to ensure that it will erode and expose the diamonds embedded in the matrix. These simple principles are the foundation of “controlled bond erosion.”



## TYPES OF CUTTING

---

There are two basic types of cutting-Dry or Wet. The choice of which type of blade to use depends on:

- The requirements of the job
- The machine/tool utilizing the diamond blade
- The preference of the operator

In the case of DRY cutting, the overwhelming popularity and quantity of hand-held saws and the flexible nature of MK Diamond blades to professionally handle most ceramic, masonry, stone and concrete materials, make the DRY cutting blade a very attractive tool. When using a DRY blade, the user must be aware of distinct operating practices to ensure optimum performance. DRY cutting blades require sufficient airflow about the blade to prevent overheating of the steel core. This is best accomplished by shallow, intermittent cuts of the material with periods of “free-spinning” (for several seconds) between each cut, to maximize the cooling process.

For WET cutting applications, MK has the exact blade to compliment both the material to be cut and the wet cutting machine to be used. During cutting operations, liberal amounts of water act as a coolant to support the cutting effectiveness and longevity of the WET blade. Additionally, using water adds to the overall safety of cutting operations by keeping the dust signature down.

Know All You Can About the Material You Wish to Cut

ITEM	NUMBER	DESCRIPTION	
1.	137166	<b>MK-200, 10" x 5/8 Arbor</b> Premium grade Diamond Blade for smooth, chip-free cutting on tile.	
2.	128074	<b>MK-215, 10" x 5/8 Arbor</b> Supreme grade diamond blade for hard materials	
3.	153252	<b>MK-315, 10" x 5/8 Arbor</b> Supreme super hi-rim diamond blade	
4.	134577-MK	<b>Dual 45° Flat Angle Guide</b>	
5.	134551-MK	<b>Rip Guide</b>	
5.	134569-MK	<b>90° Protractor</b>	
6.	152792	<b>Dressing Stone</b>	



## **ORDERING INFORMATION**

---

You may order MK Diamond products through your local MK Diamond distributor or, you may order direct from MK Diamond.

**NOTE:** There is a \$25.00 minimum order when ordering direct from MK Diamond. All purchases must be made using VISA, MasterCard or American Express.

When ordering direct from MK Diamond, please have the following information ready before calling:

- The Model Number of the saw
- The Serial Number of the saw
- Where the saw was purchased and when
- The Part Number for the part(s) being ordered
- The Part Description for the part(s) being ordered

All parts may be ordered by calling toll free to – 800 421-5830 or 310 539-5221 and asking for Customer Service. For technical questions, call – 800 474-5594.

## **RETURN MATERIALS POLICY**

---

To expedite the service relative to the return of a product purchased through MK Diamond, please observe the following:

**NOTE:** When returning all items, they must have been purchased within the previous twelve (12) months.

- Have the Model Number of the saw
- Have the Serial Number of the saw
- Have the location of where the saw was purchased
- Have the date when the saw was purchased
- Contact Customer Service for approval to return the item(s)
- Obtain a Returned Goods Number (RGA) authorizing the return
- Follow the packaging instructions in the following section
- Ensure your item(s) are prepaid to the destination

For returned items, call toll free to – 800 421-5830 or 310 539-5221 and ask for Customer Service. For technical questions, call – 800 474-5594 or 310 257-2845.

## **PACKAGING INSTRUCTIONS**

---

- Remove the Cutting Head and Support Angle Assembly
- Dry the saw before shipping
- When packing, include the following: MK-370, Diamond Blade, Blade Guard and Support Angle Assembly and Adjustable Cutting Guide (Other Accessories are not required)
- Package the unit in its original container or one of comparable size (do not ship the unit partially exposed)
- Ensure all parts are secured in the packaging to prevent moving

## **AUTHORIZED SERVICE CENTERS**

---

For quicker repair time, you may contact MK Diamond Customer Service, toll free, at 800 421-5830 or 310 539-5221 for the Authorized Service Center closest to you or visit our web site at [www.mkdiamond.com](http://www.mkdiamond.com). For technical questions, call – 800 474-5594.

**MK-370 TILE SAW**  
**OWNERS MANUAL & OPERATING INSTRUCTIONS**



**MK Diamond Products, Inc.**

MK Diamond Products, Inc.  
1315 Storm Parkway  
Torrance, CA 90501

Toll-Free: (800) 421-5830  
Phone: (310) 539-5221  
Fax: (310) 539-5158  
[www.mkdiamond.com](http://www.mkdiamond.com)