

Alpha[®] Ecocutter Dry Tile Cutting System Instruction Manual

Version 5

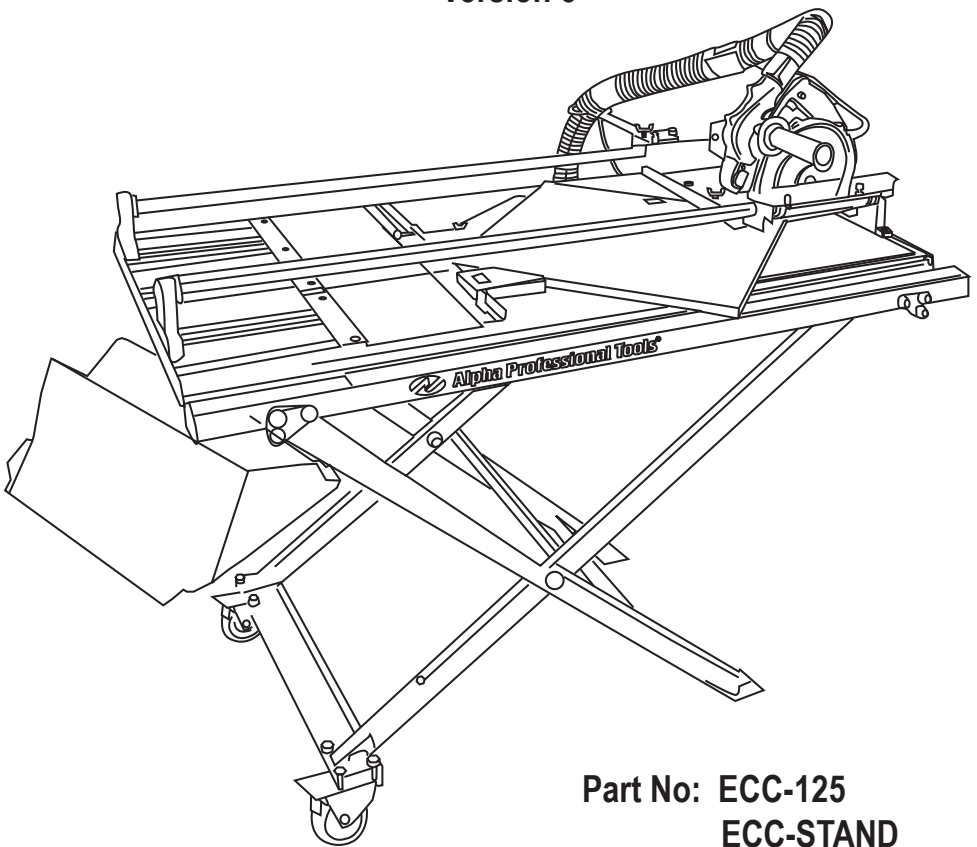

Part No: ECC-125
ECC-STAND
ECC-TABLE

 **Alpha Professional Tools[®]**

103 Bauer Drive, Oakland, NJ 07436 • 800-648-7229 • Fax: 800-286-0114

www.alpha-tools.com

TABLE OF CONTENTS

Introduction.....	3
About the Symbols	3
Safety Instructions	3
Ecocutter Stand.....	6
Components.....	6
Assembly of Ecocutter Stand.....	7
Caster Installation.....	8
Ecocutter Stand Schematic and Parts List	10
Ecocutter Table.....	12
Components.....	12
Instructions on Removing Ecocutter Table from Box.....	13
Instructions on Handling Ecocutter Table.....	14
Recommended Method	15
Assembling Table to Stand.....	17
Installation of the Hose Holder to the Saw Base	20
Installation of the Angle and Rip Guide.....	22
Ecocutter Table Schematic.....	24
Ecocutter Table Parts List	25
Installation of Ecocutter to Saw Base	26
Stabilizer.....	28
Blade Height Adjustment	29
Table Side Extension Support	32
Ecocutter Dust Hose and Bag Installation	33
Ecocutter Schematic.....	36
Ecocutter Parts List.....	37

INTRODUCTION

Thank you for purchasing the Alpha® Ecocutter Dry Tile Cutting System. Please read this instruction manual thoroughly to ensure safe and correct use of the Ecocutter Dry Tile Cutting System. Keep this manual in a place where operators can access it easily whenever necessary.

► ABOUT THE SYMBOLS

According to the hazard level, all safety notes in this manual are classified into “DANGER”, “WARNING”, and “CAUTION”.

 **DANGER!** Death or serious personal injury is imminent when handling this stone cutter incorrectly.

 **WARNING!** There is a possibility of death or serious personal injury when handling this stone cutter incorrectly.

 **CAUTION!** There is a possibility of personal injury or property damage when handling this stone cutter incorrectly.

Note: In some situations, failing to observe **WARNING** notes could result in  serious personal injury. Be sure to read and observe the safety notes to ensure safe and correct use of the stone cutter.

 **CAUTION!**

The following are important notes for products, operation, and maintenance applicable to this stone cutter.

► SAFETY INSTRUCTIONS

Read all these instructions before attempting to operate this product.

 **WARNING!**

When using electric tools, basic safety precautions should always be followed to reduce the risk of fire, electric shock, and personal injury, including the following.

For Safe Operation

1. **Keep work area clean**
Cluttered areas and benches invite injuries.
2. **Consider work area environment**
Do not expose power tools to rain. Do not use power tools in damp or wet locations without GFCI protection. Keep work areas well lit. Do not use the tool in presence of flammable liquids or gases.
3. **Guard against electric shock**
Prevent body contact with grounded surfaces. For example: pipes, radiators, ranges, and refrigerator enclosures; use grounded outlets.
4. **Keep children and visitors away**
Do not let visitors contact tool or extension cord. All visitors should be kept away from work area. Keep out of reach of children.
5. **Tool Storage**
When not in use, tools should be stored in a secure dry location. A locked storage area or high shelf out of children's reach is ideal.
6. **Do not force the tool**
It will do the job better and be safer at the rate for which it was intended.
7. **Use the right tool**
Do not force a small tool or attachment to do the job of a heavy-duty tool. Do not use the tool for purposes it is not designed for – (for example – do not use stone cutter for cutting tree limbs or logs.)
8. **Dress properly**
Do not wear loose clothing or jewelry. Items such as these can be caught in moving parts. Rubber gloves and non-skid footwear are recommended when working outdoors. Wear protective hair covering to contain long hair.
9. **Use safety equipment**
Always wear safety glasses and if necessary, a face shield, dust mask and hearing protection.
10. **Do not abuse the electrical cord**
Never carry the tool by the electrical cord or pull it to disconnect from receptacle. Keep the electrical cord away from heat, oil and sharp edges.
11. **Secure workpiece**
Use clamps or a vise to hold workpiece rather than using your hands.
12. **Do not overreach**
Keep proper footing and balance at all times.
13. **Maintain tools with care**
Keep tools sharp and clean for better and safer performance. Follow instructions for lubricating and changing accessories. Inspect the electrical cord periodically and if damaged, have it repaired by authorized service facility. Inspect extension cords periodically and replace if damaged. Keep handles dry, clean and free from oil and grease.

14. **Disconnect tools**
Disconnect the tool from the power supply when not in use, before servicing, and when changing accessories, such as blades, bits, cutters.
15. **Remove adjusting keys and wrenches**
Check to see that keys and adjusting wrenches are removed from the tool before turning it on.
16. **Avoid unintentional starting**
Do not carry a plugged-in tool with finger on switch. Be sure the switch is off when plugging in.
17. **Outdoor use extension cords**
When tool is used outdoors, use only extension cords intended for use outdoors and so marked.
18. **Stay alert**
Use caution and do not operate tool when you are tired or on medication.
19. **Check for damaged parts**
Before using the tool each day, a guard or other part that is damaged should be carefully checked to determine that it will operate properly and perform its intended function. Check for alignment of moving parts, breakage of parts, mounting, and any other conditions that may affect its operation. A guard or other part that is damaged should be properly repaired or replaced by an authorized service center unless otherwise indicated elsewhere in this instruction manual. Have defective switches replaced by authorized service center. Do not use the tool if it cannot be turned on and off by the switch.
20. **Warning**
The use of any other accessory or attachment other than recommended in this instruction manual or the catalog may present a risk of personal injury and could void the warranty.
21. **Only qualified technicians should repair this tool**
This electric tool is manufactured in accordance with the standard safety rules. Only experts may carry out the repair of electric tools; otherwise, it may cause considerable danger for the operator.

ALPHA® ECOCUTTER STAND (ECC-STAND)

After removal of all cutting table base components from packing, check for each item listed below:

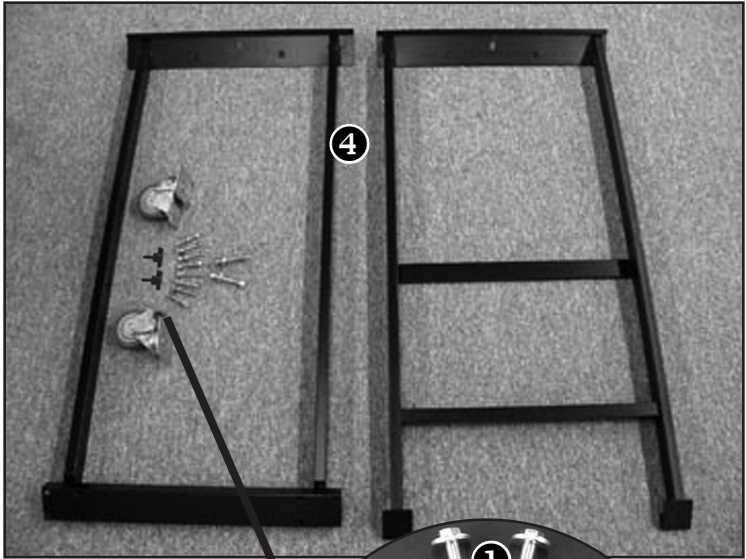



Figure-1

► COMPONENTS:

1. 2 Bolts and Hardware (for folding leg assembly) (Part No. 200026)
2. 8 Bolts and Hardware (for casters)  (Part No. 200022)
3. 2 Locking Casters
4. 2 Legs (Front Saw Stand, Part No. 200020 — Rear Saw Stand, Part No. 200021)
5. 2 Wing Screws (Part No. 200024)

► ASSEMBLY OF ECOCUTTER STAND

The following tools will be needed to assemble this base section of the cutting table for the Ecocutter.

- 2 - 14mm wrenches
- 1 - 11mm wrench
- 1 - 10mm wrench

1. Position the two legs to create a scissor configuration as shown in Figure 2.

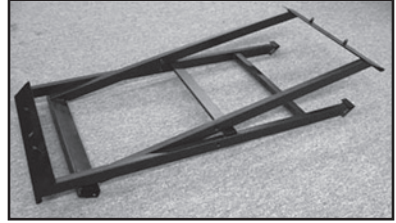

Figure-2

2. Turn assembly on its side and align the holes located at the center of each leg. Insert one of the two large bolts (Part No. 200026) using a flat washer on each side followed by the nylon insert lock nut as shown in Figure 3 and Figure 4.

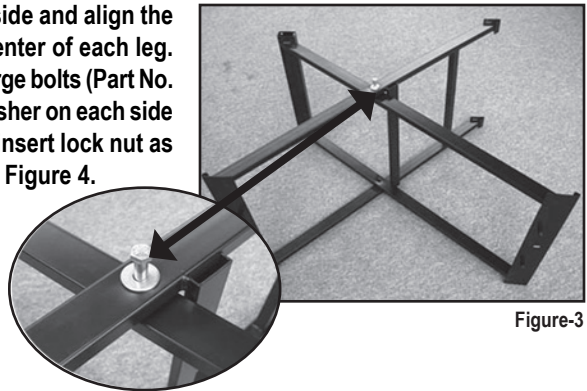
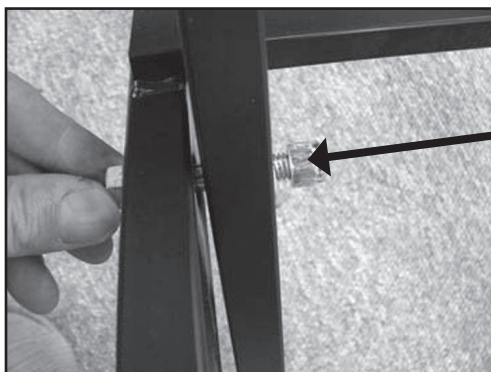

Figure-3



Nylon Lock Nut

Figure-4

3. Tighten bolts until a slight gap remains between the two legs. See Figure 5 and Figure 6.
4. Legs must move freely in a scissor motion (See Figure 6). Note: an over tightened condition will cause binding of the legs.



Figure-5

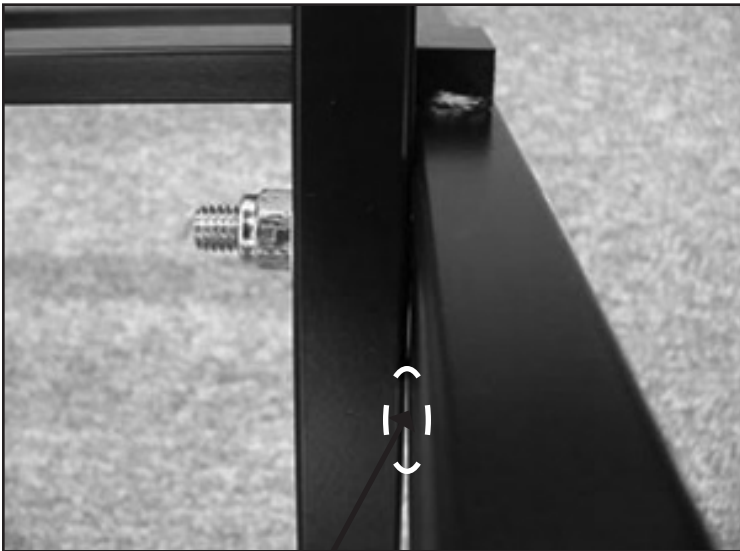

Figure-6

Air Gap

► CASTER INSTALLATION

1. Place and align caster mounting plate with mounting holes on base of stand leg as shown in Figure 7 and Figure 8.



Figure-7



Figure-8

2. Insert the four bolts for the casters with washers on each side and lock nut as shown in Figure 9.
3. Tighten until snug.



Figure-9

4. Repeat process for second caster as shown in Figure 10.



Figure-10

5. See Figure 11 for complete assembled base stand in the opened position.

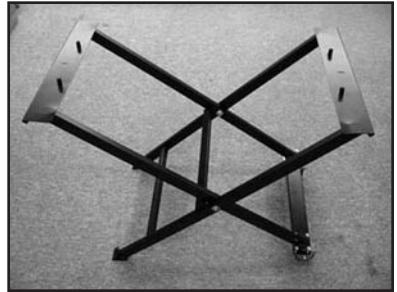

Figure-11

6. See Figure 12 for complete assembled base stand in the folded position used for transport.

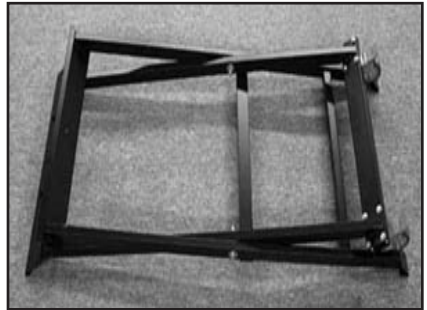
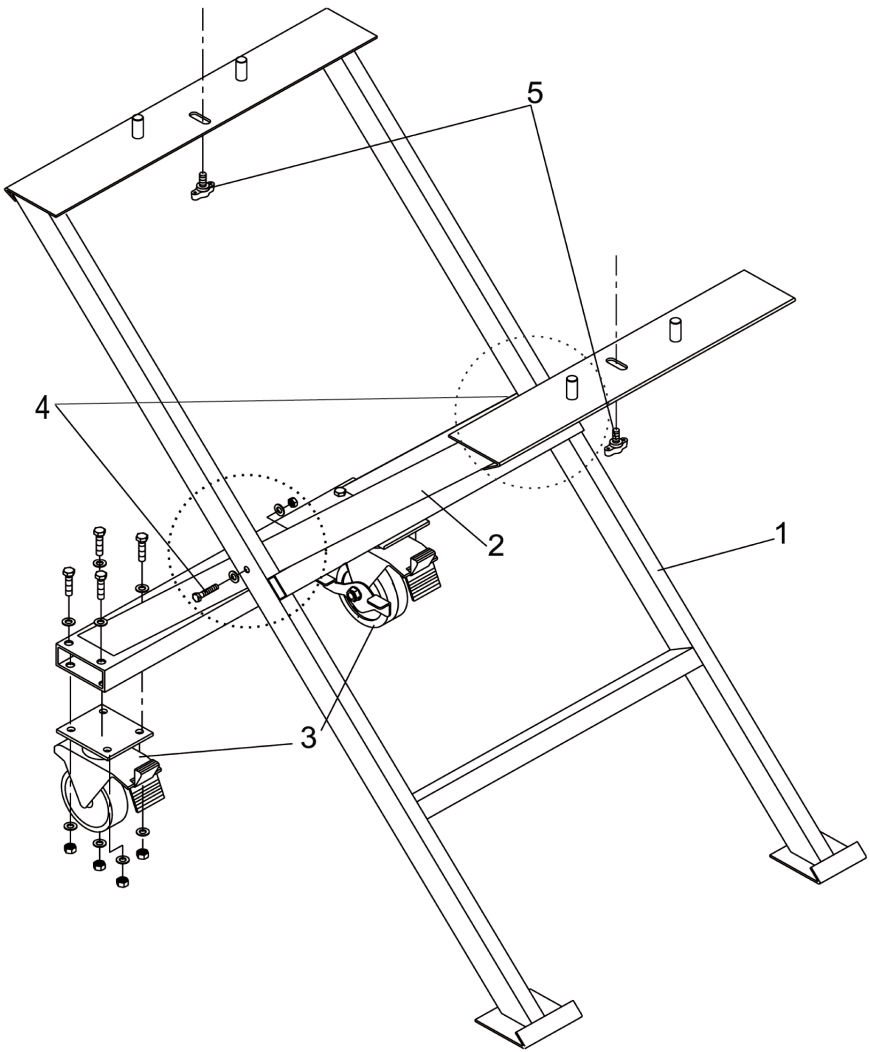

Figure-12

ALPHA® ECOCUTTER STAND SCHEMATIC (ECC-STAND)



DRAWING NO.	PART NO.	DESCRIPTION	QUANTITY
1	200020	Front Saw Stand	1
2	200021	Rear Saw Stand	1
3	200022	Wheel/Brake Assembly	1
4	200026	Saw Stand Screw Set	1
5	200024	Wing Screw (2 pc set)	1
—	200023	Saw Stand Assembly	ALL

ALPHA® ECOCUTTER TABLE (ECC-TABLE)

 CAUTION!

**WHEN REMOVING ECOCUTTER TABLE FROM CARTON,
DO NOT LIFT BY RAIL TUBE. ALWAYS USE SIDE HANDLE.**

See page 13 for details.

After removal of all cutting table components from packing, check for each item listed below:

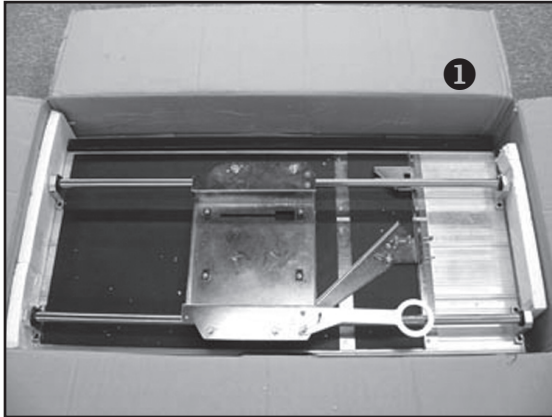
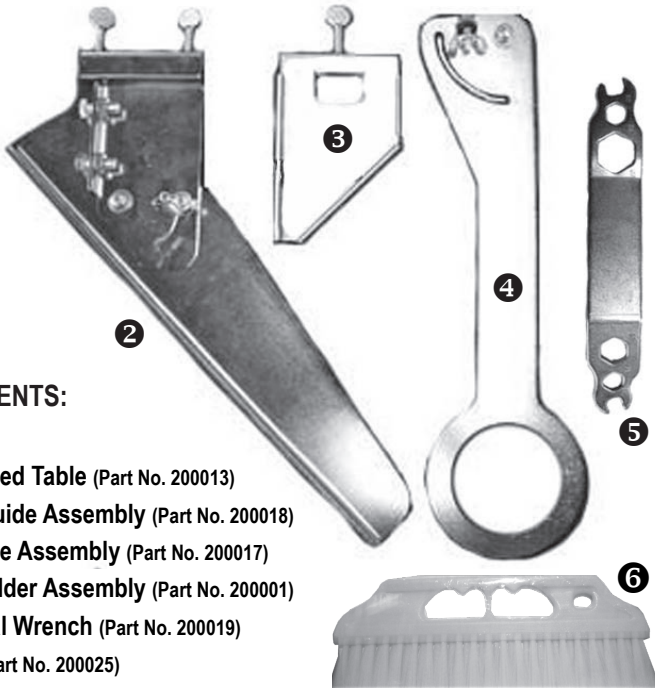

Figure-13



► COMPONENTS:

1. **Assembled Table** (Part No. 200013)
2. **Angle Guide Assembly** (Part No. 200018)
3. **Rip Guide Assembly** (Part No. 200017)
4. **Hose Holder Assembly** (Part No. 200001)
5. **Universal Wrench** (Part No. 200019)
6. **Brush** (Part No. 200025)

**► INSTRUCTIONS ON REMOVING THE ECOCUTTER TABLE FROM BOX
RECOMMENDED METHOD**

Step 1.

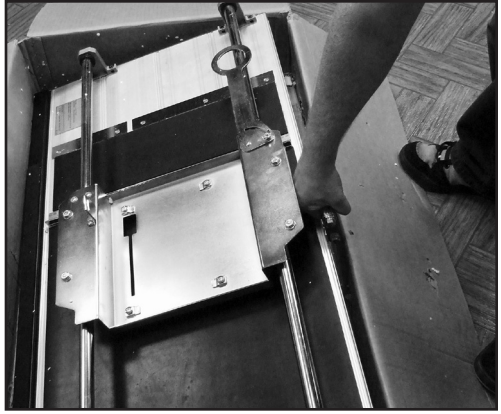

Figure-14

Step 2.



Figure-15

Step 3.



Figure-16

► INSTRUCTIONS ON HANDLING THE ECOCUTTER TABLE

 CAUTION!

NON-RECOMMENDED METHODS

Please note the following illustrations carefully before assembling table to stand.

**DO NOT LIFT TABLE BY RAIL TUBE.
TABLE WILL BE DAMAGED
IF HANDLED IMPROPERLY.**

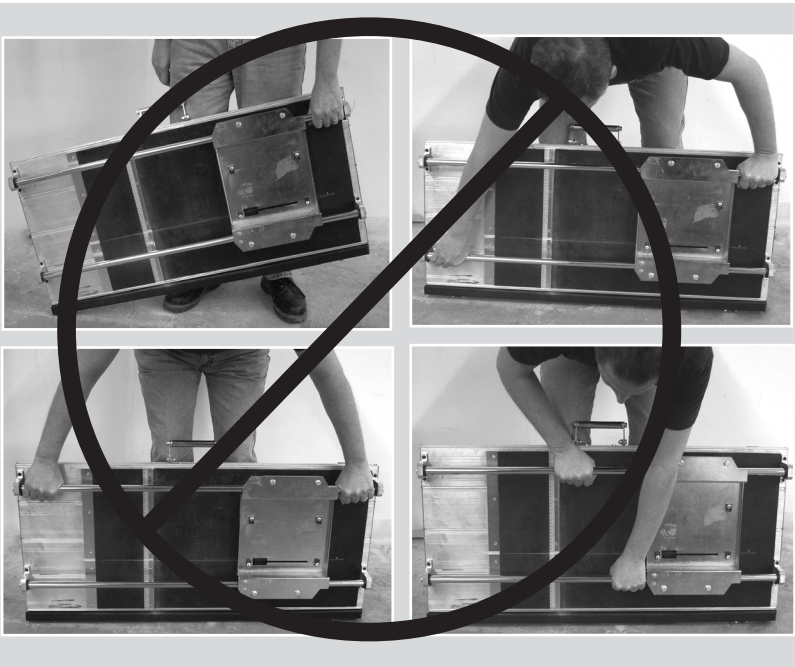

Figure-17

RECOMMENDED METHOD

Step 1.



Figure-18

Step 2.



Figure-19

RECOMMENDED METHOD

Step 3.



Figure-20

Step 4.



Figure-21

► ASSEMBLING TABLE TO STAND

1. Place stand in open position.

Set caster wheel locks to the locked position by pressing latch down as shown in Figure 22 and Figure 23.



Figure-22



Figure-23

Locked Position

2. Pick up table by sides and place on stand.

* Follow the recommended steps on pages 15 and 16



Figure-24



Figure-25

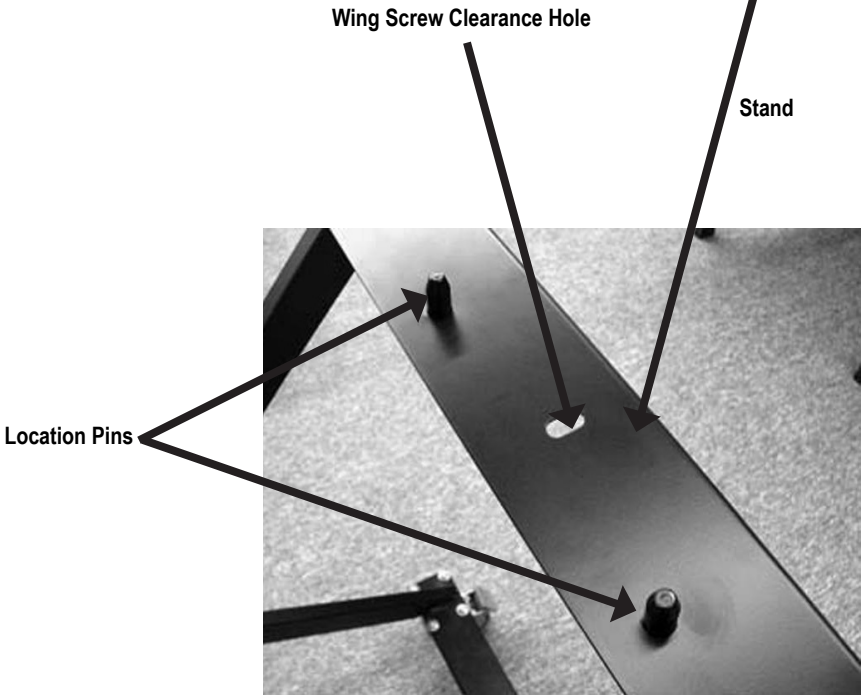

Figure-26

3. After placement of the table onto the stand, adjust table so the side extension support slider tube fits outside of the location pins of both sides of the stand as shown in Figure 27.

Location Pins

Side Extension Support Slider Tube

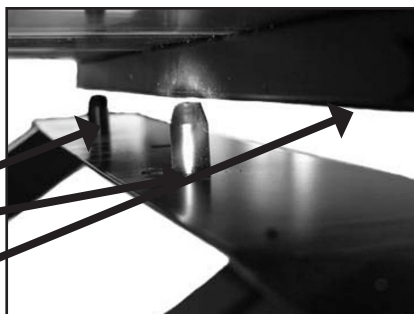

Figure-27

4. Align wing screw clearance hole with threaded hole of table cross support. (See Figure 28).

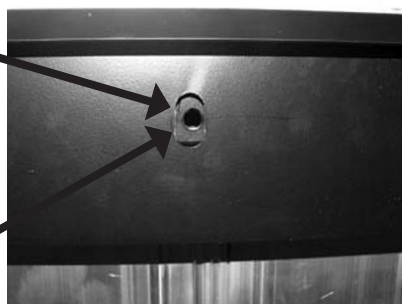

Figure-28

5. Insert and tighten wing screw to a hand tight condition as shown in Figure 29.
6. Repeat process for opposite side to complete the stand assembly.



Figure-29

► **INSTALLATION OF THE HOSE HOLDER TO THE SAW BASE**

1. **Position and align the hose holder to the saw base as shown in Figure 30, making note of the threaded hole locations.**

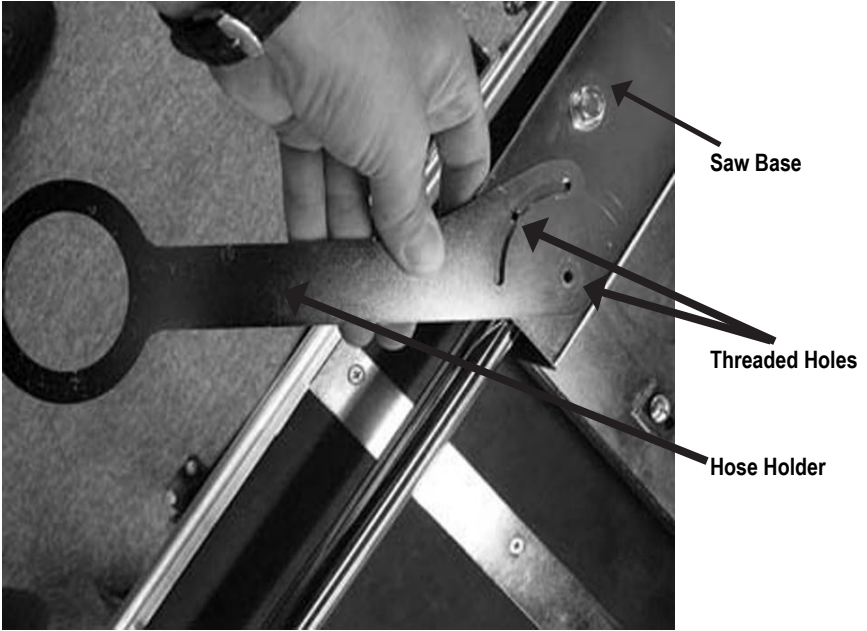

Figure-30

2. **Install supplied phillips screw and washer and hand tighten with screw driver as shown in Figure 31.**



Figure-31

3. Install supplied screw from the underside of the saw base as shown in Figure 32.

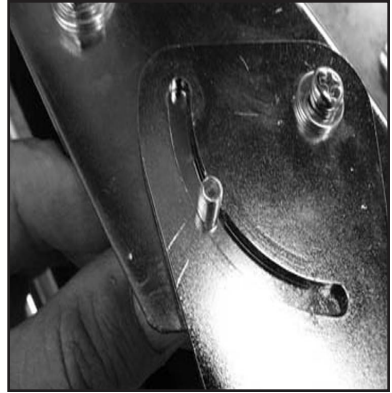

Figure-32

4. Install supplied washer, lock washer and wing nut as shown in Figure 33.



Figure-33

5. Position hose holder at 90 degrees to the saw base and hand tighten wing nut to lock in position.



Figure-34

► INSTALLATION OF THE ANGLE AND RIP GUIDES

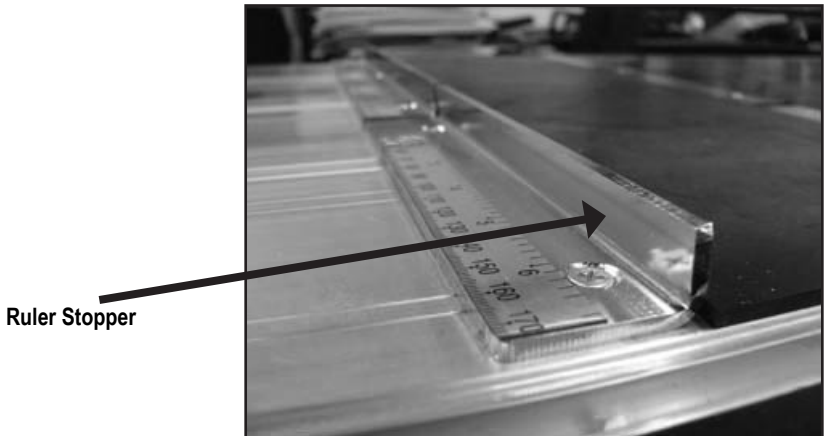
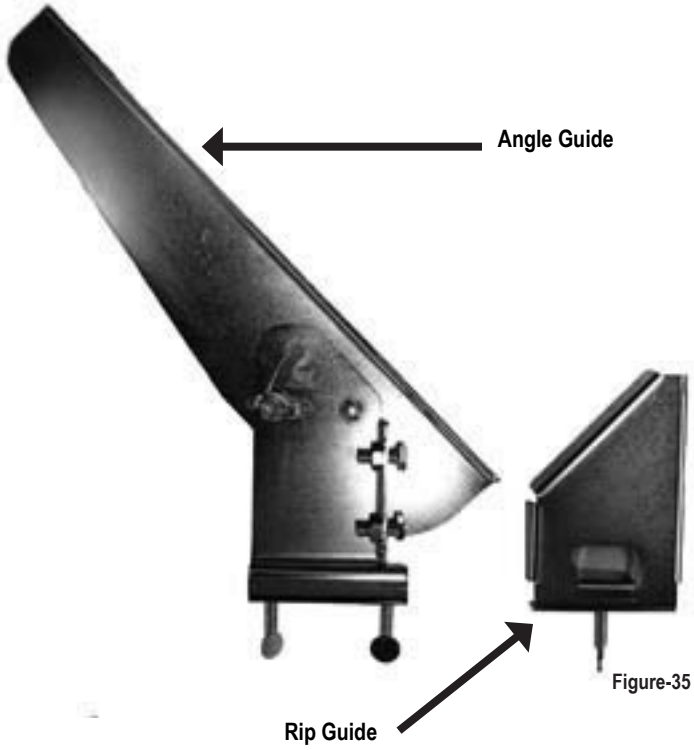

1. Angle and Rip Guides will mount to Ruler Stopper.

2. Place channel of angle and rip guide over edge of ruler stopper and then tighten thumb nail screws to secure, when in the correct position.

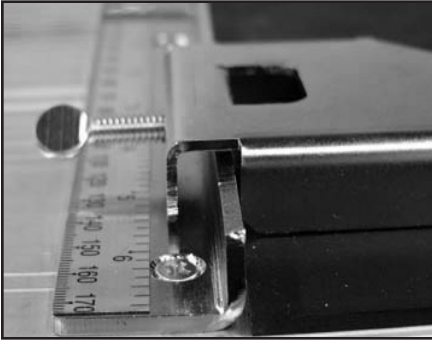

Figure-37

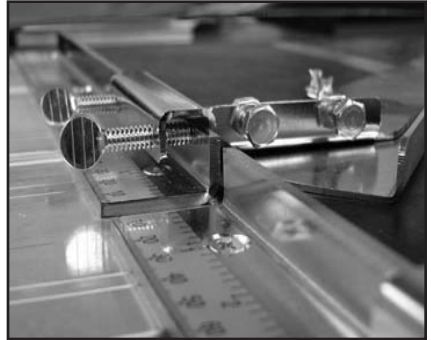

Figure-38

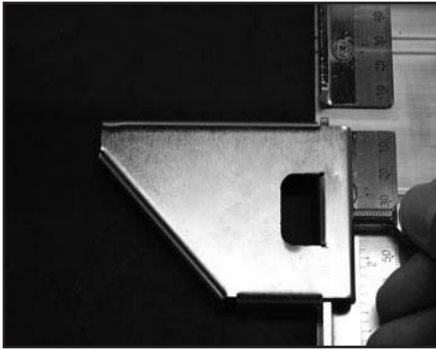

Figure-39

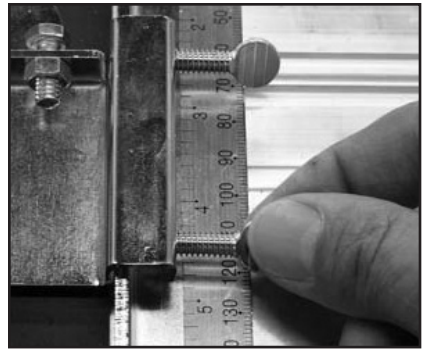

Figure-40

Example of mounted Angle and Rip Guides for cutting diagonally across a tile.

Angle Guide

Rip Guide

Ruler Stopper

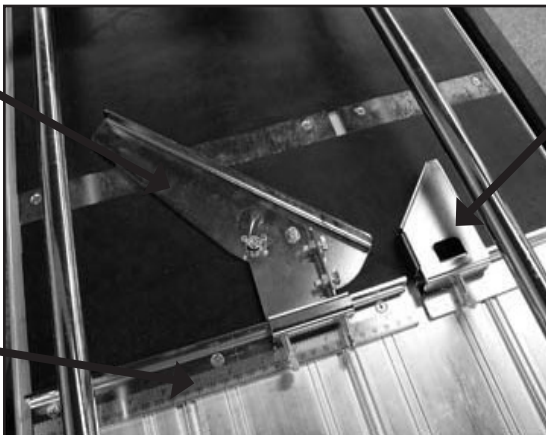
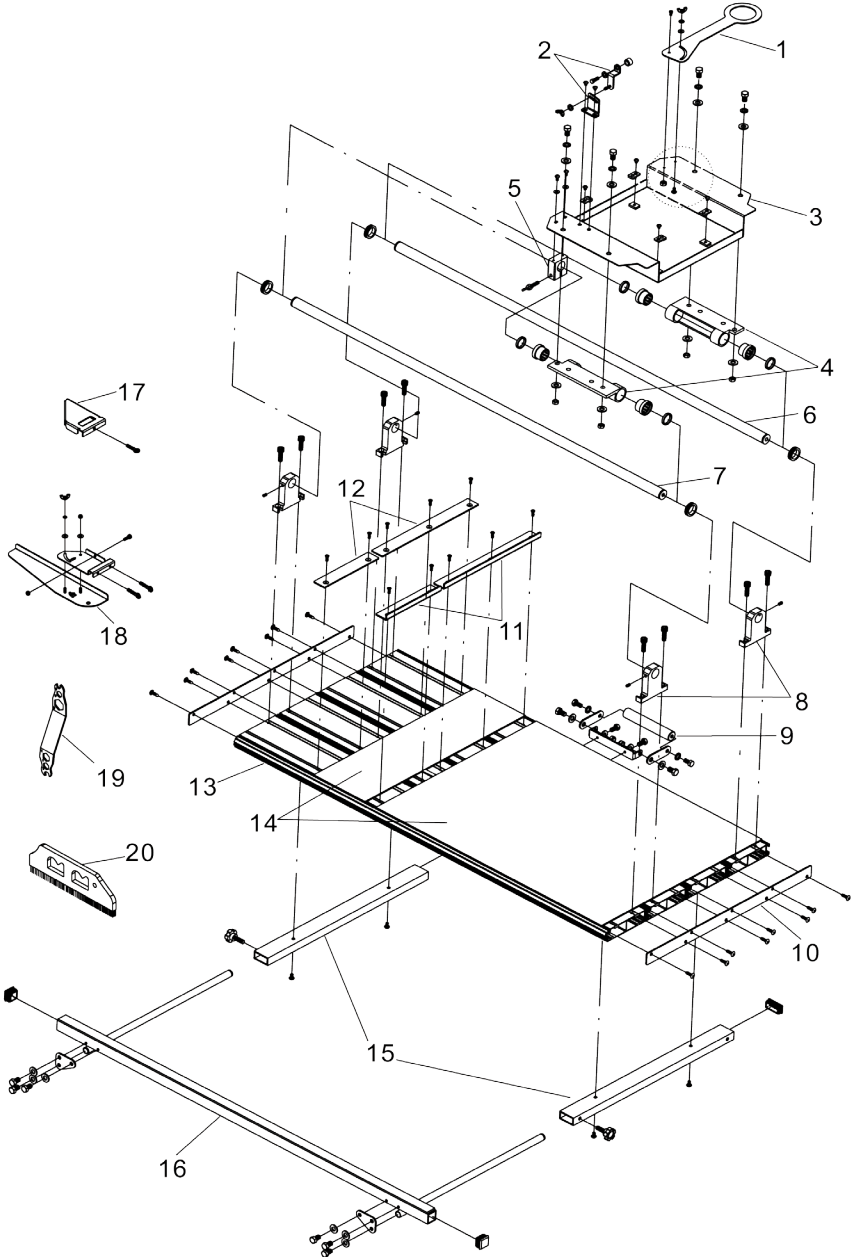

Figure-41

ALPHA® ECOCUTTER TABLE SCHEMATIC (ECC-TABLE)



ALPHA® ECOCUTTER TABLE PARTS LIST

DRAWING NO.	PART NO.	DESCRIPTION	QUANTITY
1	200001	Hose Holder Assembly	1
2	200002	Stabilizer Assembly	1
3	200003	Saw Base Assembly	1
4	200004	Tube Slider Assembly	1
5	200005	Base Stopper Assembly	1
6	200006	Hollow Rail Tube Assembly	1
7	200007	Solid Rail Tube Assembly	1
8	200008	Rail Holder Assembly	1
9	200009	Carry Handle Assembly	1
10	200010	End Seal Plate Assembly	1
11	200011	Removable Ruler Stopper Assembly	1
12	200012	Removable Filler Assembly	1
13	200013	Assembled Table	1
14	200014	Rubber Mat Set	1
15	200015	Side Extension Support Slider Tube Assembly	1
16	200016	Side Extension Support Assembly	1
17	200017	Rip Guide Assembly	1
18	200018	Angle Guide Assembly	1
19	200019	Universal Wrench	1
20	200025	Brush	1

INSTALLATION OF ECOCUTTER TO SAW BASE

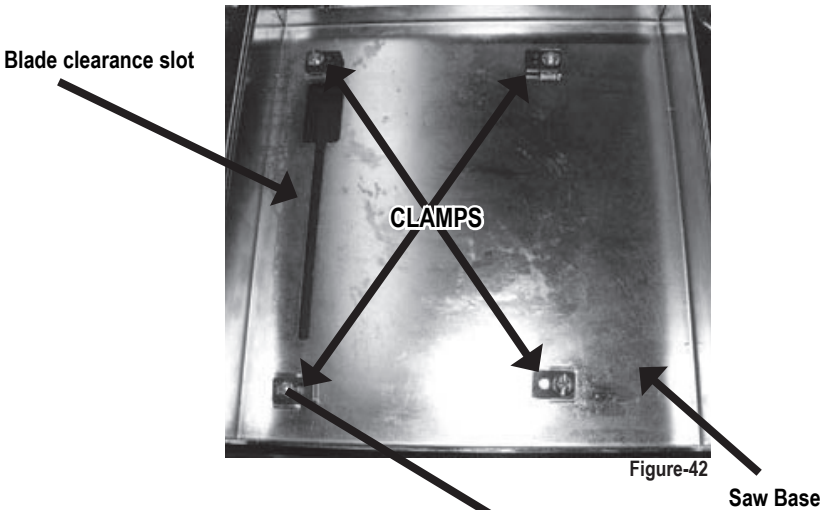

1. Locate and remove clamp assembly from saw base.

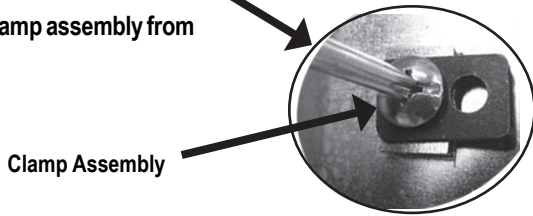

2. Loosen wing screw on the depth indicator of the Ecocutter and raise to the highest level as shown in Figure 43.
3. Hand tighten wing screw at this position.

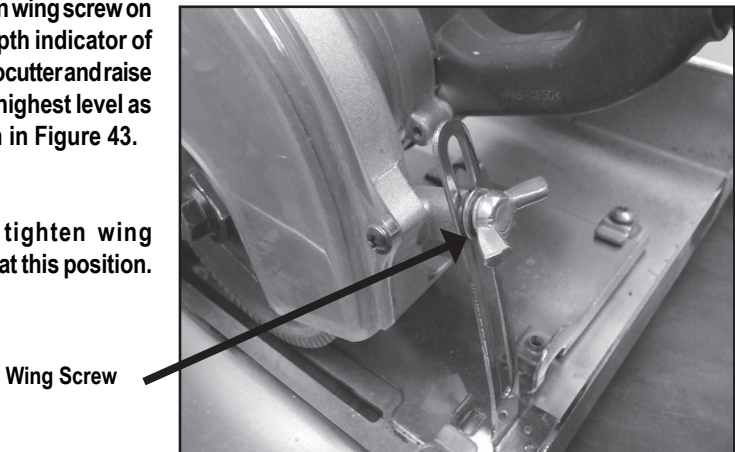

4. Place and position the Ecocutter within the clamp bases as shown in Figure 44.

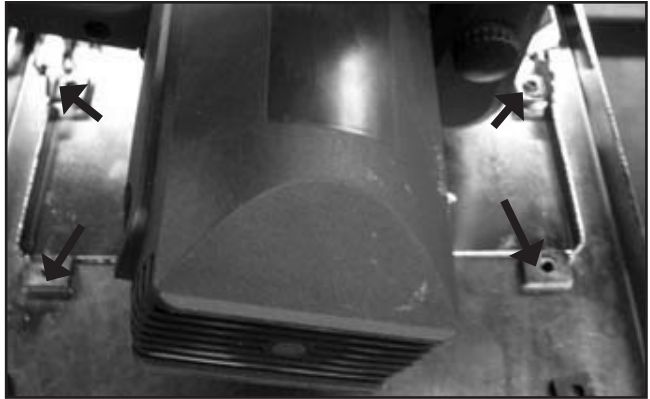

Figure-44

5. Place each of the four clamp assemblies over the Ecocutter base and tighten as shown in Figure 45.



Figure-45

STABILIZER

1. Using supplied hardware, screw stabilizer base to saw base as shown in Figure 46.
2. Using supplied bolt, screw top portion of stabilizer to Ecocutter.

Note: Leave stabilizer bracket screw and wing nut loose at this time.

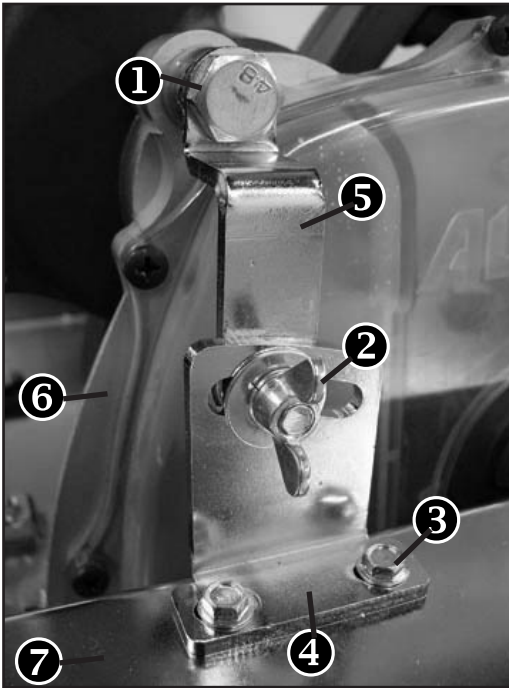

Figure-46

COMPONENTS:

- | | | |
|---------------------------------|---|--------------------------------------|
| 1. Stabilizer Bracket Bolt | } | Stablizer Assembly (Part No. 200002) |
| 2. Wing Nut | | |
| 3. Base hardware | | |
| 4. Stabilizer Base | | |
| 5. Stabilizer Bracket | | |
| 6. Ecocutter (Part No. ECC-125) | | |
| 7. Saw Base (Part No. 200003) | | |

BLADE HEIGHT ADJUSTMENT

Ecocutter blade height must be properly adjusted for cutting depth before use. The following steps will ensure proper operation during cutting.

Note: Incorrect blade height adjustment will result in damage to the blade and saw base.

1. Loosen wing screw on the depth indicator of the Ecocutter. (See Figure 47)

Wing Screw



Figure-47

2. Bring Ecocutter down gently until blade segments just touches rubber table pad. (See Figure 48)



Figure-48

3. Tighten wing nut to a hand tight condition. (See Figure 49)



Figure-49

4. Tighten stabilizer bracket bolt with wrench to a snug condition. (See Figure 50)



Figure-50

5. Loosen carriage lock wing screw which is located at the front right of the carriage assembly. (See Figure 51)

Wing Screw

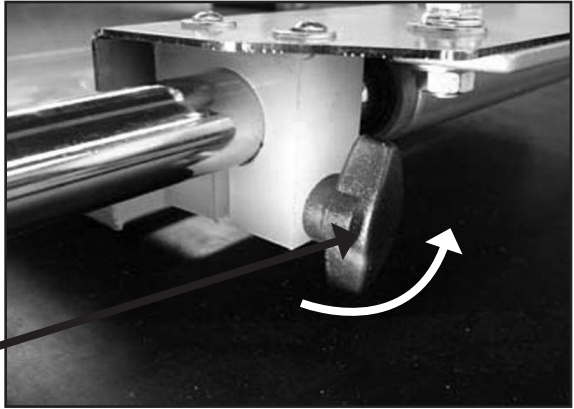

Figure-51

6. Slide carriage assembly in a back and forth motion to assure smooth operation as shown in Figure 52.

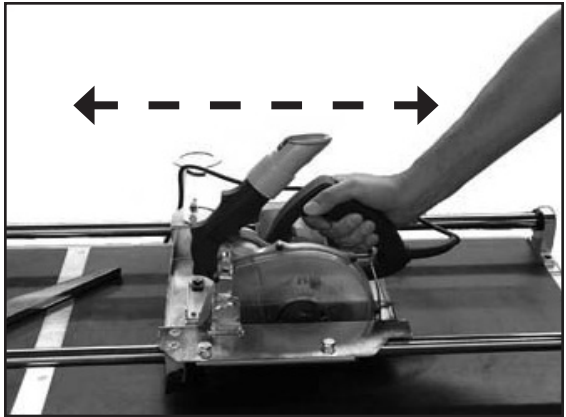

Figure-52

TABLE SIDE EXTENSION SUPPORT

This extension support is used for stabilization of large pieces of material.

1. Locate the two lock knobs located on the underside of the table. (See Figure 54)
3. Loosen these knobs and pull the side extension support outward towards desired location as shown. (See Figure 53)
4. Re-tighten the lock knobs to a hand tight condition.

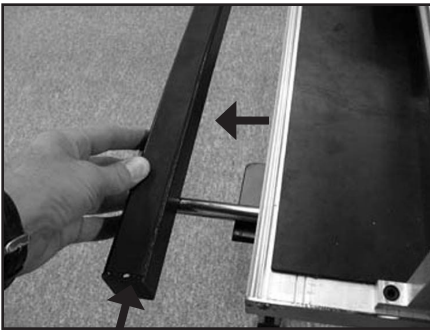

Figure-53

Side Extension Support



Figure-54

ECOCUTTER DUST HOSE AND BAG INSTALLATION

1. Install back flow preventer assembly to the Ecocutter exhaust port with the dust gate in the upright position as shown in Figure 55.

Dust Gate

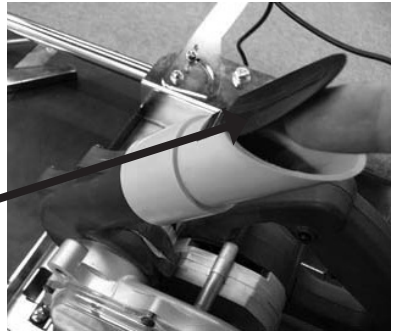

Figure-55

2. Slide the dust hose onto the assembly as shown in Figure 56.

Dust Hose

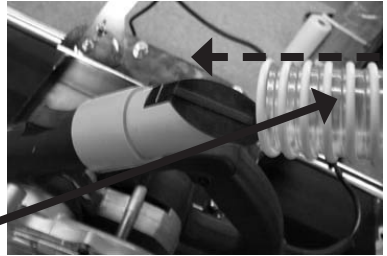

Figure-56

3. Check for a tight connection as shown in Figure 57.

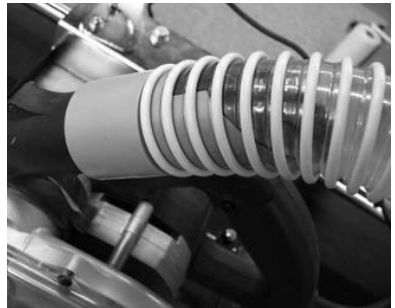

Figure-57

4. Route the dust hose and power cord through the hose holder as shown in Figure 58.

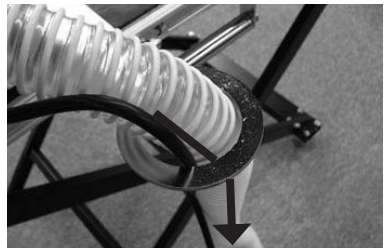
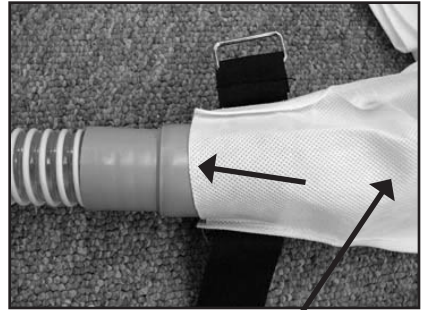

Figure-58

5. Slip the dust bag over hose end as shown in Figure 59.



Dust bag

Figure-59

6. Secure with hook and loop strap as shown as in Figure 60.

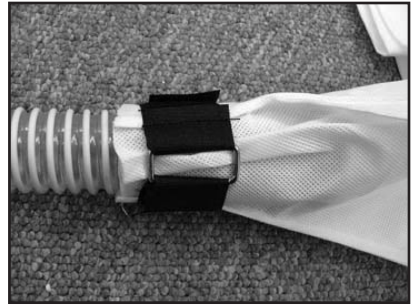

Figure-60

7. See Figure 61 for completed Dust Bag installation.



Figure-61

8. Use supplied hook and loop straps (Part No. 133551) to secure power cord to dust hose, and dust hose to hoseholder. (See Figure 62)

Hook and Loop Strap

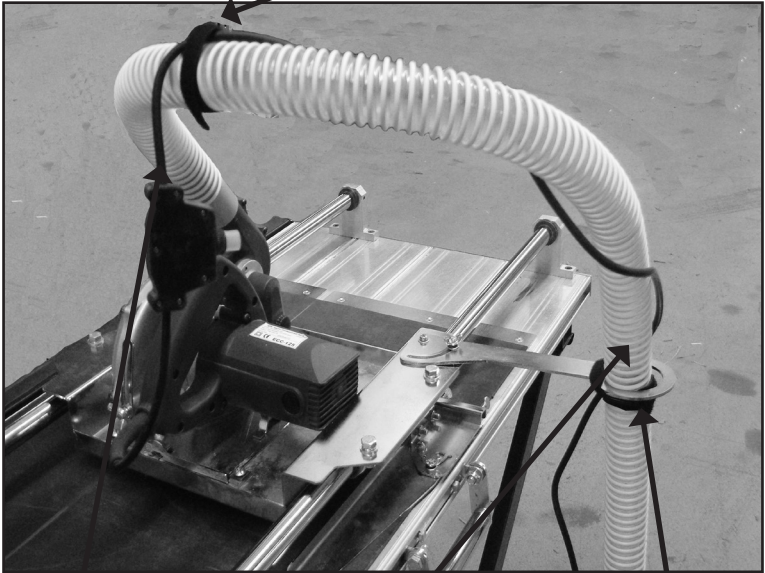

Figure-62

Power Cord

Dust Hose

Hook and Loop Strap

ALPHA® ECOCUTTER SCHEMATIC (ECC-125)

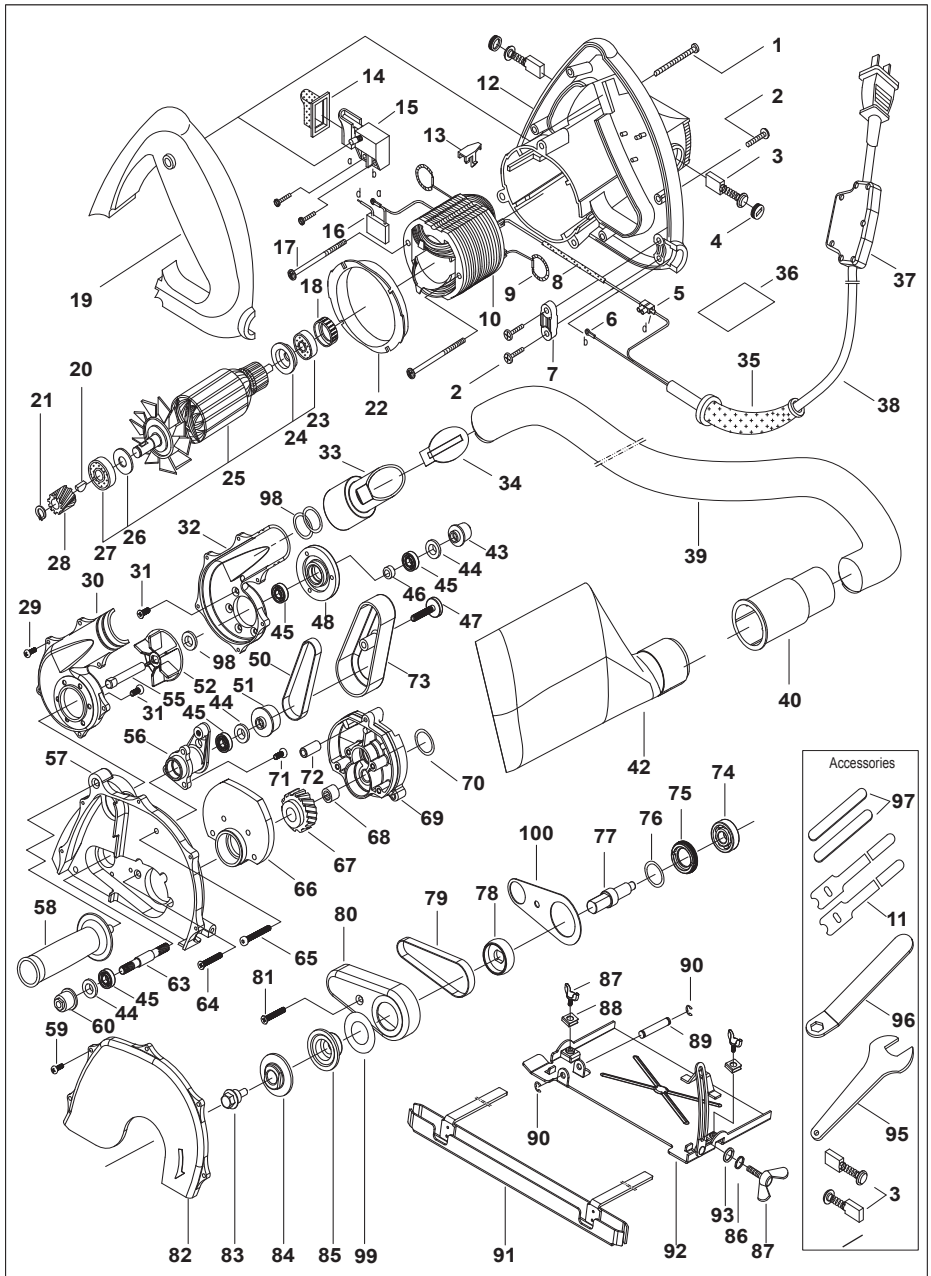

ALPHA® ECOCUTTER PARTS LIST

DRAWING NO.	PART NO.	DESCRIPTION	QUANTITY
1	133080	Screw M5x40	3
2	130031	Self-tapping Screw 3.9 X19	2
3	133033	Carbon Brush (2 pc set)	2
4	133032	Brush Cap	2
5	130618	Block Terminal	2
6	133040	Wire Terminal	2
7	133086	Cable Clamp	1
8	133042	Insulation Pipe	2
9	133034	Brush Terminal Assembly	2
10	133436/133004	Field Coil 110V/220V	1
11	133551	Hook & Loop Straps	2
12	133003	Rear Motor Housing (Blue)	1
13	133041	Cable Clip	2
14	133044	Rubber Switch Cover	1
15	133043	Switch (With Screw)	1
16	133392	Condenser Assembly	1
17	133029	Self-tapping Screw 4.8x65	2
18	133028	Bearing Sleeve	1
19	133078	Handle (for ECC-125)	1
20	133050	Woodruff Key	1
21	133051	Snap Ring M8	1
22	133030	Air Bridge	1
23	133025	Bearing 608-2RZ	1
24	133024	Insulation Disc	1
25	133439/133012	Armature 110V/220V	1
26	133026	Bearing Cover	1
27	133027	Bearing 629-2RZ	1
28	133048	Gear (Small)	1
29	133460	Self-tapping Screw 3.9X16	6
30	133493	Fan Case L	1
31	133505	Cap Screws M5x10	3
32	133497	Fan Case R	1

ALPHA® ECOCUTTER PARTS LIST

DRAWING NO.	PART NO.	DESCRIPTION	QUANTITY
33	133531	Dust Gate	1
34	133530	Anti-Back-Flow Flap	1
35	133047	Cable Sleeve	1
36	133452/133547	Rated Plate 110V/220V	1
37	133475/133546	Breaker Assembly (w/cord)110V/220V	1
38	133474	Cord (w/o breaker)110V	1
39	133533	Dust Hose	1
40	133532	Dust Bag Holder	1
42	133544	Dust Bag w/Strap 17"x13 1-1/2" x12"	1
43	133503	Pulley (Outside) 21mm OD LHT Fan	1
44	133502	Felt Rings D19xD12xT2	3
45	133492	Bearing 698 2RS	4
46	133498	Spacer D12xd8.5x4T	1
47	133511	Knob Bolt	1
48	133500	Bearing Housing	1
50	133508	Outer Belt	1
51	133488	Pulley (Outside) 24mm OD RHT	1
52	133495	Fan	1
55	133496	Fan Shaft	1
56	133486	Housing Adapter	1
57	133483	Main Housing	1
58	801086	Side Handle (for AWS-125/ECC-125)	1
59	133522	Screws M4x15	5
60	133490	Pulley (Inside) 18mm OD RHT	1
63	133487	Pulley Shaft	1
64	133513	Screw M4x25	4
65	133545	Screw M5x40	1
66	133386	Gear Housing	1
67	133058	Gear (Big)	1
68	133066	Needle Bearing Bk 0810	1
69	133368	Gear Housing	1
70	133067	O Ring 25.5*2	1

ALPHA® ECOCUTTER PARTS LIST

DRAWING NO.	PART NO.	DESCRIPTION	QUANTITY
71	133512	Screw M5x15	3
72	133529	Sleeve	1
73	133510	Outer Cover	1
74	133053	Bearing 6201-2RS	1
75	133060	Screw Cap	1
76	133062	O Ring 18x2.5	1
77	133481	Spindle (for ECC-125)	1
78	133506	Pulley (Inside) 36mm OD Spindle	1
79	133509	Inner Belt	1
80	133514	Inner Cover	1
81	133515	Screw M5x30 (use part #133513)	1
82	133521	Side Cover	1
83	133519	Flange Bolt	1
84	133518	Flange Outer (for ECC-125)	1
85	133516	Flange Inner (for ECC-125)	1
86	133071	Flat Washer M6	1
87	133084	Wing Screw	3
88	133269	Washer For Ruler	2
89	133528	Guide Pin	1
90	130798	Retaining Rings -E	1
91	133527	TT Ruler Guide (for ECC-125)	1
92	133523	Base Plate Assembly	1
93	133072	Spring Washer M6	1
95	133535	Wrench (for ECC-125)	1
96	133534	Hexagon Ring Spanner	1
97	133369	Felt Strip Set	2
98	133615	Felt Rings D26.6xD12.5xT2	1
99	133616	Dust Shield D43xD23xT0.35	1
100	133696	Inner Cover Gasket (for ECC-125)	1
(not shown)	133536	BMC (Blow Mold Case) for ECC-125	1
(not shown)	801392	Dust Bag for Carriage 16x13-1/2x8	1



103 Bauer Drive, Oakland, NJ 07436 • 800-648-7229 • Fax: 800-286-0114
www.alpha-tools.com

Copyright © 2013 Alpha Professional Tools. All rights reserved.

02/28/2013