

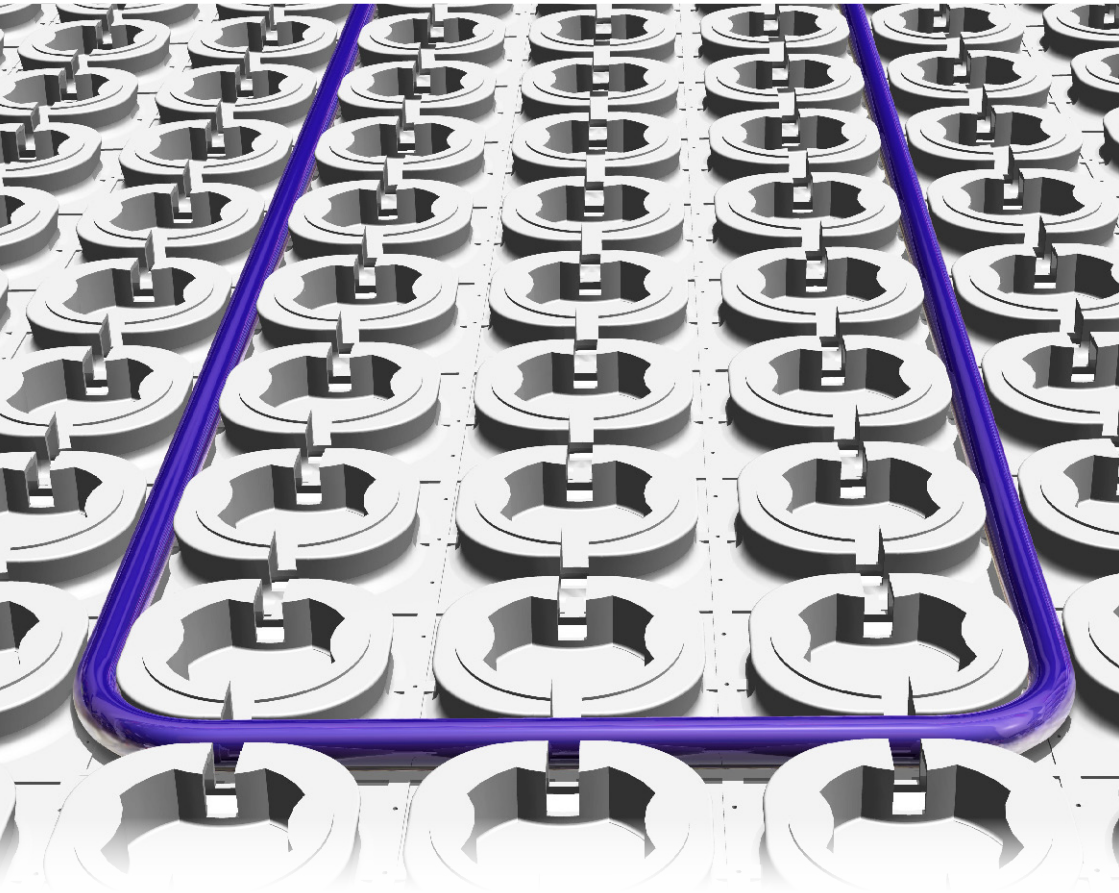

Globally Proven
Construction Solutions

STRATA_HEAT™ Wire Installation Manual

0804 Series



Technical Helpline

+1-203-393-0010 ext 1235

IMPORTANT!

Please read this manual before attempting to install the STRATA_HEAT™ Wire



Table of Contents

Quick Install Guide	4-5
Components Required for Installation	6
Do's & Don'ts	7-8
Step 1 - Electrical Supply	9-11
Step 2 - Subfloor Considerations	12-13
Step 3 - Lay STRATA_HEAT™ Mat	14-15
Step 4 - Layout Planning	16-19
Step 5 - Install STRATA_HEAT Wire	20-21
Step 6 - Tiled Floor Covering.....	22
Step 7 - Lay the Floor Covering.....	23-24
Step 8 - Connect the Thermostat	25
Troubleshooting	26-27
Performance Troubleshooting	28-29
How to Test the STRATA_HEAT Wire and Floor Sensors	30
Layout Plan.....	31
Control Card.....	32
Warranty	33
Technical Specifications.....	34-35
Subfloor Considerations -Spacing Strips	36-37
Alternate Installation - Installing Using Spacing Strips	38-39

WARNING

Your STRATA_HEAT™ Radiant Floor Heating system has been designed so that installation is quick and straight forward, but as with all electrical systems, certain procedures must be strictly followed. Please ensure that you have the correct STRATA_HEAT Wire for the area you wish to heat.

LATICRETE, accepts no liability, expressed or implied, for any loss or consequential damage suffered as a result of installations which in any way contravene the instructions that follow.

It is important that before, during and after installation that all requirements are met and understood. If the instructions are followed, you should have no problems. If you require help at any stage, please contact LATICRETE Technical Services.

You may also find a copy of this manual, STRATA_HEAT Wire Installation Manual, and other helpful information on our website:

www.laticrete.com



Make electrical provisions for the STRATA_HEAT™ Wire. A deep, 4" x 4" x 2 3/4" (100 x 100 x 70 mm) UL/cUL certified double-gang box with a mud plate should be provided by the electrician for the thermostat connections. The power leads must be protected where they leave the floor by a suitable approved conduit where required by electrical code.



Ensure the subfloor is smooth, dry and free from dust.



We recommend installing 1/4" (6 mm) HYDRO BAN® Board for optimum performance.

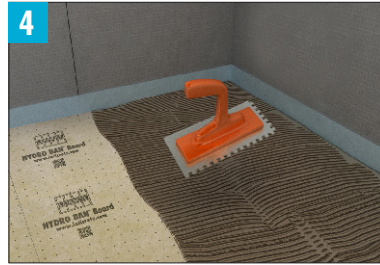

Where required, install perimeter strip around the perimeter of the room.

Apply a thin-set layer to the substrate using a 1/4" x 1/4" (6 x 6 mm) square notch trowel.



Cut the STRATA_HEAT Mat to size and press into the adhesive bed using a float or roller, removing any air pockets. Lay additional sheets as above ensuring that the pegs are aligned.

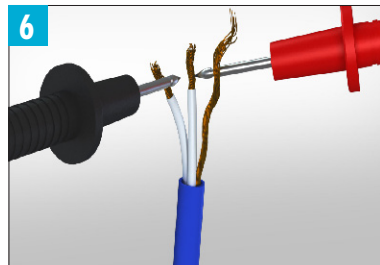

Test the resistance of the STRATA_HEAT Wire ensuring it is within the range set out in the Reference Resistance Band table on Page 34.

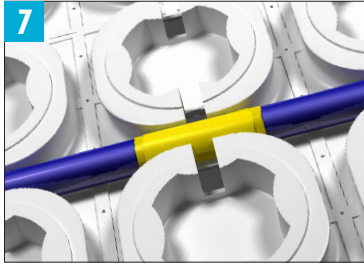

STRATA_HEAT Wire is manufactured so that there is a spliceless connection where the heating cable meets the coldtail. **This connection is marked with tape and MUST be installed within the STRATA_HEAT Mat and covered with adhesive and not exposed.** Ensure this connection is installed straight in the STRATA_HEAT Mat and not bent around a peg.

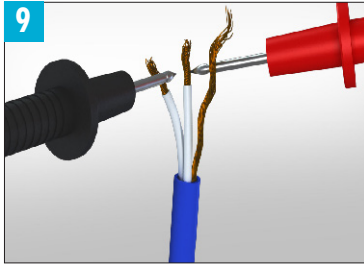

Test the resistance of the STRATA_HEAT Wire after installation and check against the previous value to ensure no damage has occurred.

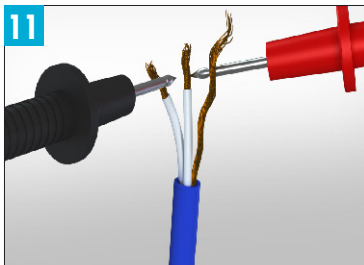

Test the resistance of the heating cable after tiling and check against previous values to ensure no damage has occurred.

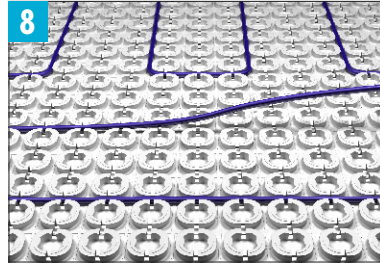

Install the STRATA_HEAT™ Wire at the chosen spacing. Maintain a minimum 3 peg (2 3/8" / 60 mm) spacing for UL Compliance. Install the floor sensor centrally between two runs of the heater wires. For the termination joint, channel a groove in the STRATA_HEAT Mat, enabling the joint to fit flush with the top of the mat. DO NOT tape over the termination joint.

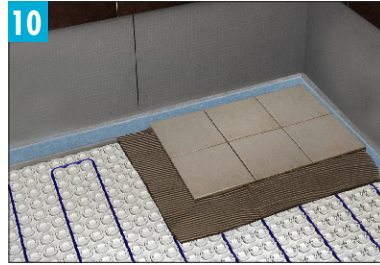

Lay the tiles over the STRATA_HEAT Mat and Wire. The STRATA_HEAT Wire, including spliceless connection and termination joint, must be completely encased by the tile adhesive and not exposed. Use PERMACOLOR or SPECTRALOCK grout when grouting



Connect your STRATA_HEAT Thermostat.

Components Required for Installation

Components available from LATICRETE

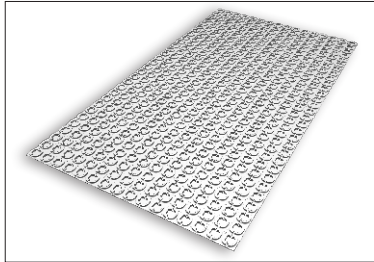

STRATA_HEAT™ Mat

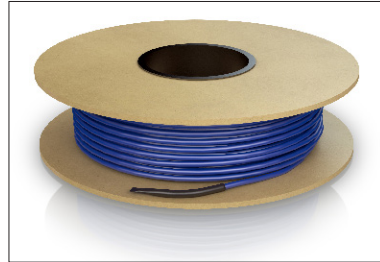

STRATA_HEAT Wire



SKU: 9450-0014-2

1/4" (6 mm) HYDRO BAN® Board for insulation



STRATA_HEAT Thermostat and Floor Sensor

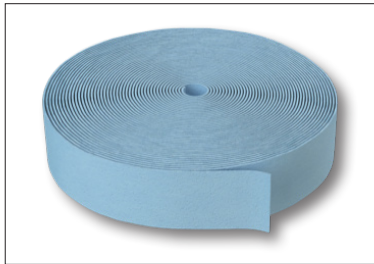

Perimeter Strip (Optional)

Additional components needed as part of your heating installation:

- Digital Multi-meter required for testing the resistance of the heater and floor sensor.
- Electrical tape to secure the floor sensor.
- UL/cUL certified electrical housing, back boxes and junction boxes.
- UL/cUL certified electrical trunking/conduit for housing the power leads.
- UL/cUL certified electrical conduit for housing the power leads.
- LATICRETE® Tile Adhesive and Grout.

Do's & Don'ts

DO'S

- DO** Ensure that tile adhesive used is compatible with underfloor heating and suitable for application with non porous materials such as the STRATA_HEAT™ Mat.
- DO** Maintain a spacing that produces no more than 16 W/ft² (162 W/m²) of heat input into the floor.
- DO** Make sure all electrical work is done by qualified persons in accordance with local building and electrical codes, the National Electrical Code (NEC), especially article 424, Part V of the NEC, ANSI/NFPA 70, for the US and Canadian Electrical Code, Part 1, for Canada.
- DO** Check the resistance of the STRATA_HEAT Wire before, during, and after installation to ensure that no damage has occurred. A tolerance of +/- 5% is allowed.
- DO** Make sure the STRATA_HEAT Wire is connected to a UL/cUL certified GFCI controller or breaker where required by code.
- DO** Plan the heating system layout and installation so that any drilling after tiling (e.g. for fixtures such as vanity units, tubs) will not damage the wiring. Remember to keep a copy for future reference.
- DO** Ensure that the STRATA_HEAT Wire is separated at least 8" (20.3 cm) from other heat sources such as baseboard heating, heating vents, lights and chimneys.
- DO** Ensure that the minimum free bending radius of the STRATA_HEAT Wire is no less than 1" (25 mm).
- DO** Ensure the subfloor is fully cured and stable before commencing installation of the STRATA_HEAT Wire.
- DO** Ensure that each tile is solidly bedded in tile adhesive, with no gaps or voids beneath.
- DO** Make sure that the STRATA_HEAT Wire, including spliceless connection and termination joint are positioned under the final floor finish and completely embedded in thin-set/adhesive.
- DO** Install the floor probe for the STRATA_HEAT Thermostat. It should be installed centrally between two STRATA_HEAT Wire runs. Ensure that the sensor does not touch or cross over the STRATA_HEAT Wire.
- DO** Ensure that you have electrical provisions to run the STRATA_HEAT Wiring at 120VAC /or 240VAC depending on the system being installed.
- DO** Check the wattage and voltage of the STRATA_HEAT Wire to ensure you have the correct system for your application.
- DO** Ensure any parallel runs of cold tail and sensor wire are kept separated within the wall, using UL/cUL certified conduit where required.
- DO** Make sure that the system is fully grounded following the wiring instructions provided.
- DO** Use a separate STRATA_HEAT Wire for the shower area.
- DO** Indicate which circuits supply power to the STRATA_HEAT Wire on the circuit breaker. Attach the product labels for each STRATA_HEAT Wire to the circuit breaker, for future reference.

Do's & Don'ts

DON'T'S

- DON'T** Install parallel runs of STRATA_HEAT™ Wire closer than 3" (76.2 mm) at any time if using wire spacing strips or 2 3/8" (61 mm) if using STRATA_HEAT Mat. Refer to the Layout Planning page for further guidance.
- DON'T** Cross the STRATA_HEAT Wire over another run, over coldtails or the floor sensor. This will cause overheating and will damage the STRATA_HEAT Wire.
- DON'T** Cut or shorten the STRATA_HEAT Wire at any time.
- DON'T** Install the STRATA_HEAT Wire with staples or other metal fixings that can cause damage.
- DON'T** Store tiles, sharp or heavy objects on top of the STRATA_HEAT Wire
- DON'T** Install STRATA_HEAT Wire below 5°F (-15°C).
- DON'T** Attempt to bypass the GFCI if it trips and cannot be reset during normal operation. Consult a qualified electrician or call the technical helpline for further assistance.
- DON'T** Install the STRATA_HEAT Wire under permanent fixtures or in closets.
- DON'T** Commence installation on a screed that has not been fully cured.
- DON'T** Cover the spliceless connection or termination joint with tape. This may cause air pockets resulting in the joints overheating.
- DON'T** Install the STRATA_HEAT Wire beyond the room or area in which they originate.
- DON'T** Attempt to repair the STRATA_HEAT Wire if it is damaged. Call the technical helpline for further instructions.
- DON'T** Allow the Thermostat to exceed the maximum temperature for your final floor finish. Always check the maximum temperatures allowed with the floor covering manufacturer.
- DON'T** Switch on the installed STRATA_HEAT Wire until tile adhesive has fully cured, check adhesive manufacturer's instructions. 3 days at 70°F (21°C).
- DON'T** Install the cold leads closer than 2" (50 mm) from the STRATA_HEAT Wire. Damage to supply conductor insulation may occur.
- DON'T** Install the STRATA_HEAT Wire closer than 2" (50 mm) from the wall, partitions, and any permanently fixed objects.

WARNING: "RISK OF ELECTRIC SHOCK AND FIRE".

DAMAGE TO SUPPLY CONDUCTOR INSULATION MAY OCCUR IF CONDUCTORS ARE ROUTED LESS THAN 2" (50 MM) FROM THIS HEATING PRODUCT. CAUTION: A UL/cUL CERTIFIED GROUND FAULT PROTECTION DEVICE MUST BE USED WITH THE STRATA_HEAT™ WIRE.

ATTENTION : This product must be protected by grounding.

Step 1 - Electrical Supply

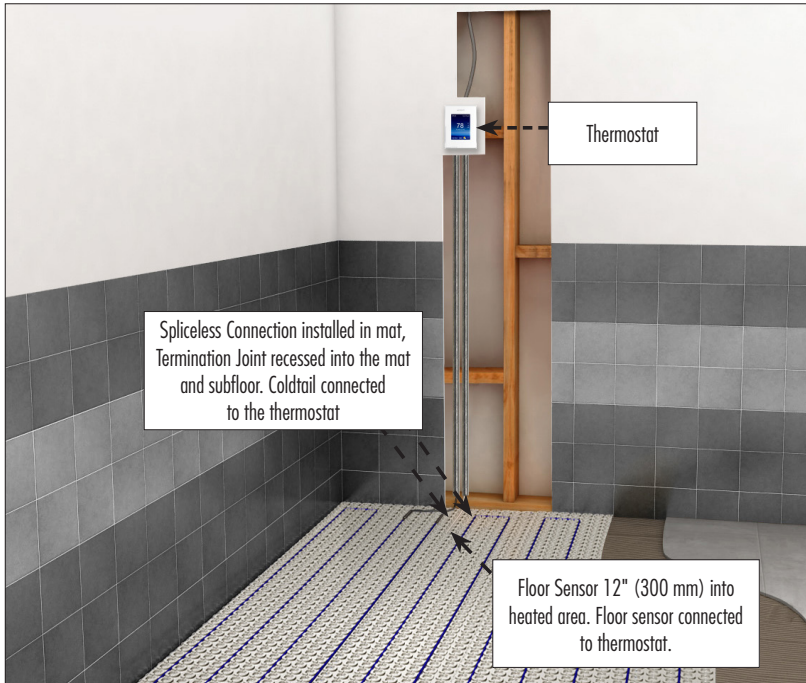

The installation of electrical systems presents risks of fire and electrical shock which can result in personal injury. All electrical connections should be carried out by a qualified electrician in accordance with the National Electrical Code and all local Codes. For installations in Canada, refer to relevant sections in the CEC.

The STRATA_HEAT™ Wire **MUST** be connected to the electrical system through a UL/cUL certified Ground Fault Circuit Interrupter ("GFCI"). If you are not using a thermostat, such as a STRATA_HEAT Thermostat with an integral GFCI, ensure that the branch circuit supplying your STRATA_HEAT Wire is GFCI protected. If possible, use a dedicated GFCI protected circuit to supply each heated zone. This requirement is critical to the safe operation of the STRATA_HEAT Wire.

For smaller areas, you may be able to utilize an existing circuit. In most cases, however, you will need a separate dedicated circuit to power the STRATA_HEAT Wire.

NOTE: The power leads must be protected where they leave the floor by a suitable UL/cUL certified conduit

NOTE: A UL/cUL certified junction box is required if more than two STRATA_HEAT Wires are being installed.

NOTE: When conducting an insulation resistance test on the supply to the STRATA_HEAT Thermostat, the thermostat and STRATA_HEAT Wire must be isolated or disconnected.

Step 1 - Electrical Supply

Typical Wiring Diagram 120V

Typical Wiring for STRATA_HEAT™ Thermostat

Dedicated 120V Circuit CSA/CEC or NEC

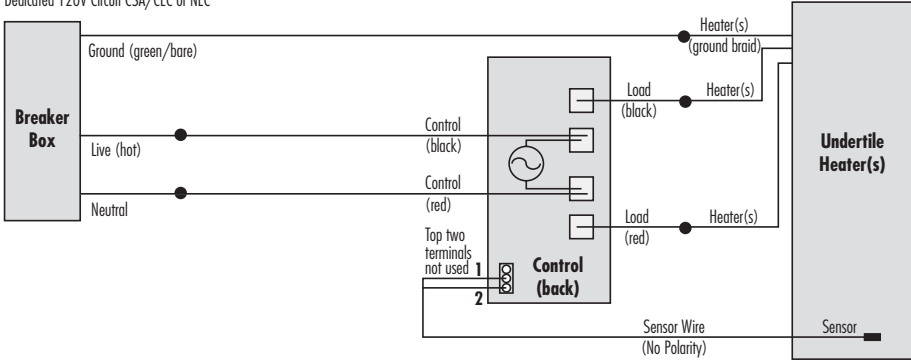

NOTE: All electrical work performed by a qualified electrician in accordance with local building and electrical codes and the Canadian Electrical Code, part 1 in Canada or the National Electrical Code in the USA, especially Article 424 of NEC, ANSI/NFPA70 and Section 62 of CEC.

Typical Wiring for STRATA_HEAT™ Thermostat and Relay

Dedicated 120V Circuit CSA/CEC or NEC

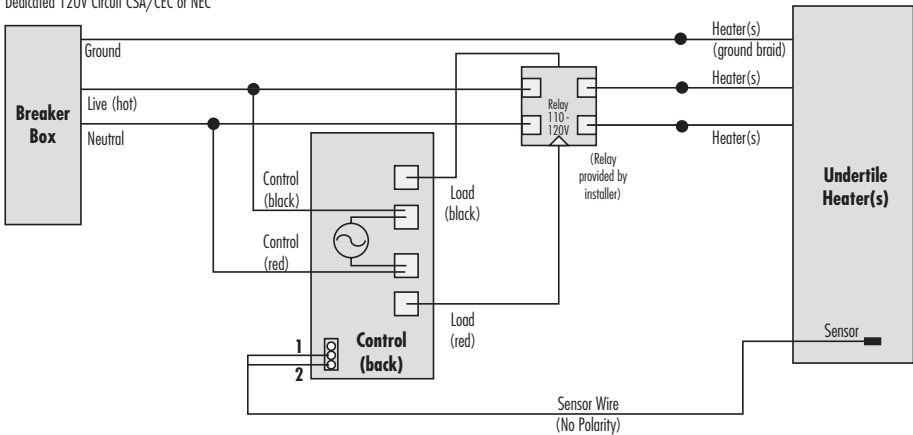

NOTE: All electrical work performed by a qualified electrician in accordance with local building and electrical codes and the Canadian Electrical Code, part 1 in Canada or the National Electrical Code in the USA, especially Article 424 of NEC, ANSI/NFPA70 and Section 62 of CEC.

Step 1 - Electrical Supply

Typical Wiring Diagram 240V

Typical Wiring for STRATA_HEAT™ Thermostat

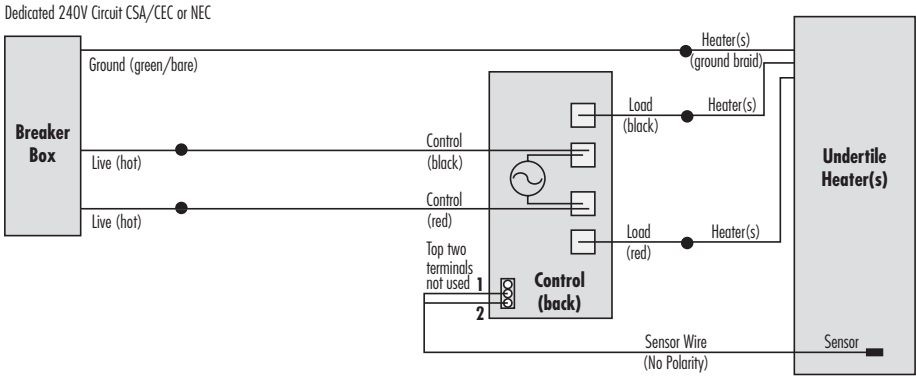

NOTE: All electrical work performed by a qualified electrician in accordance with local building and electrical codes and the Canadian Electrical Code, part 1 in Canada or the National Electrical Code in the USA, especially Article 424, Part V of the NEC ANSI/NFPA 70. Undertile heaters are to be installed in parallel across the load terminals of the thermostat or contactor and must not exceed their rated load.

Typical Wiring for STRATA_HEAT™ Thermostat and Relay

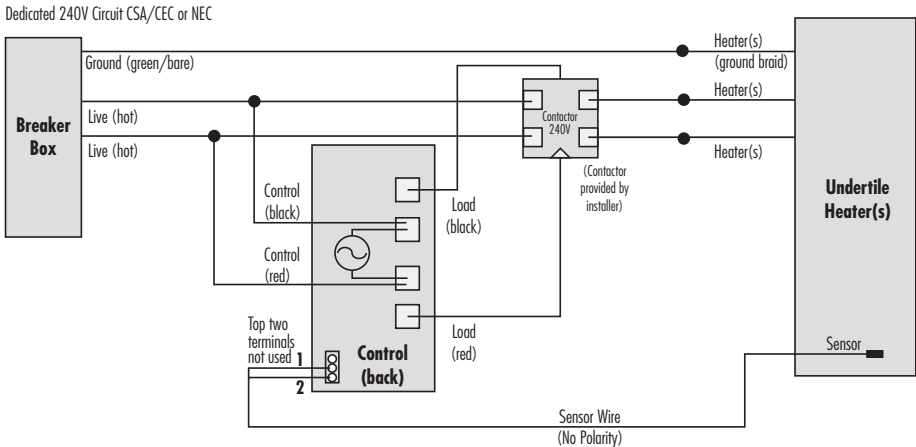

NOTE: All electrical work performed by a qualified electrician in accordance with local building and electrical codes and the Canadian Electrical Code, part 1 in Canada or the National Electrical Code in the USA, especially Article 424, Part V of the NEC ANSI/NFPA 70. Undertile heaters are to be installed in parallel across the load terminals of the thermostat or contactor and must not exceed their rated load.

NOTE: When installing the STRATA_HEAT™ Wire in kitchens or bathrooms it must be protected by a STRATA_HEAT Thermostat which contains a UL/cUL certified GFCI. If the STRATA_HEAT Wire is switched by a separate contactor its supply must be GFCI protected. To prevent nuisance tripping a STRATA_HEAT Thermostat with integral GFCI protection should not be supplied by a GFCI protected circuit.

Step 2 - Subfloor Considerations

Subfloor Preparation

Subfloors previously covered in vinyl, cork or carpeting: all old flooring and glues must be removed.

Any materials on or within the subfloor must be suitable for supporting eUFH systems. If using temperature sensitive materials beneath the eUFH system, such as damp proofing or tanking systems, contact the manufacturer for advice.

Concrete Subfloors

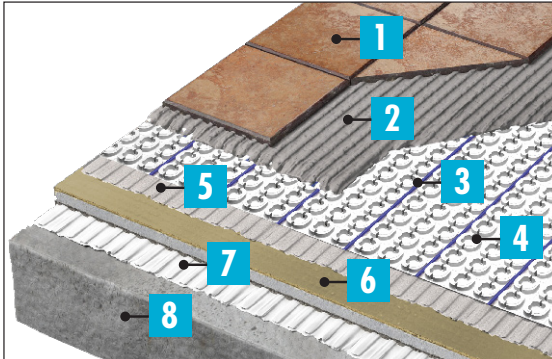

CONCRETE SUBFLOOR (Recommended)

- 1 Floor Finish
- 2 1/4" (6 mm) Minimum thin-set
- 3 STRATA_HEAT™ Wire
- 4 STRATA_HEAT Mat
- 5 Thin-set layer applied with 1/4" x 1/4" (6 mm x 6 mm) square notch trowel
- 6 HYDRO BAN® Board
- 7 Thin-set layer applied with 1/4" x 1/4" (6 mm x 6 mm) square notch trowel
- 8 Subfloor

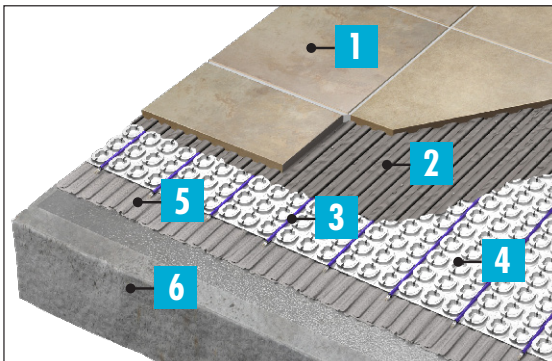

CONCRETE SUBFLOOR

- 1 Floor Finish
- 2 1/4" (6 mm) Minimum thin-set
- 3 STRATA_HEAT Wire
- 4 STRATA_HEAT Mat
- 5 Thin-set layer applied with 1/4" x 1/4" (6 mm x 6 mm) square notch trowel
- 6 Subfloor

It is recommended that you use HYDRO BAN Boards beneath the STRATA_HEAT™ system for optimum performance. The insulation will improve the systems response to heating demand, saving energy and reducing running costs.

Where expansion joints are present in the subfloor, these must be preserved up through all covering layers, including insulation (where installed) and STRATA_HEAT system.

Step 2 - Subfloor Considerations

In addition to the general subfloor preparation instructions on the previous page, plywood or OSB subfloors should be prepared for tiling in accordance with local tiling standards such as ANSI A108 Series.

Timber Subfloors

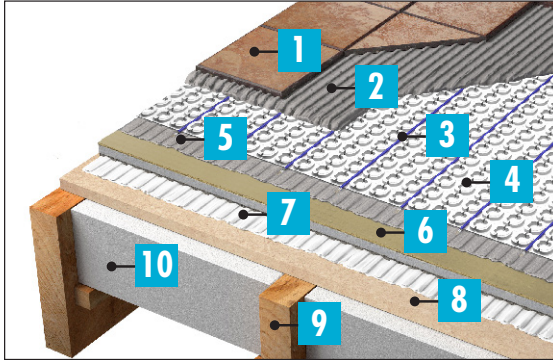

TIMBER SUBFLOOR (Recommended)

- 1 Floor Finish
- 2 1/4" (6 mm) Minimum thin-set
- 3 STRATA_HEAT™ Wire
- 4 STRATA_HEAT Mat
- 5 Thin-set layer applied with 1/4" x 1/4" (6 mm x 6 mm) square notch trowel
- 6 HYDRO BAN Board
- 7 Thin-set layer applied with 1/4" x 1/4" (6 mm x 6 mm) square notch trowel
- 8 Subfloor
- 9 Joists
- 10 Insulation

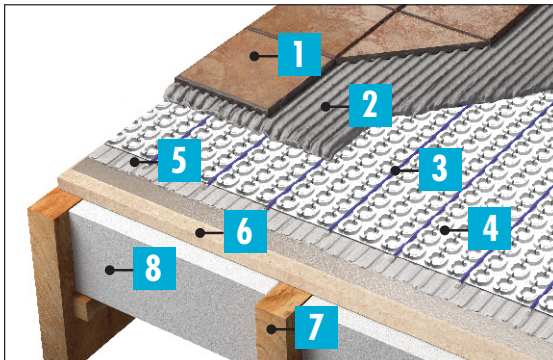

TIMBER SUBFLOOR

- 1 Floor Finish
- 2 1/4" (6 mm) Minimum thin-set
- 3 STRATA_HEAT™ Wire
- 4 STRATA_HEAT Mat
- 5 Thin-set layer applied with 1/4" x 1/4" (6 mm x 6 mm) square notch trowel
- 6 Subfloor
- 7 Joists
- 8 Insulation

Step 3 - Lay STRATA_HEAT™ Mat



Ensure the subfloor is dry and smooth. If necessary an appropriate smoothing or levelling compound should be applied.



Recommended Step - Install HYDRO BAN® Boards for insulation over the subfloor referring to DS-040.0 installation instructions.



(Optional) Install expansion strips along any perimeter or sectional expansion joints within the subfloor to preserve their function.



Measure and cut a length of STRATA_HEAT™ Mat to suit your room using a utility knife and/or scissors.

Step 3 - Lay STRATA_HEAT™ Mat



Apply a thin-set layer to the substrate using a ¼" x ¼" (6 mm x 6 mm) square notch trowel.



Position the STRATA_HEAT™ Mat, fleece side down into the adhesive bed.

Embed the mat into the adhesive bed using a float/roller removing any air pockets.

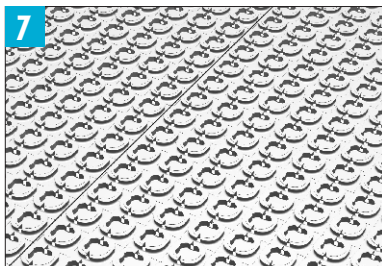

Repeat steps 5 & 6 for subsequent runs of the STRATA_HEAT Mat, butting the mats together tightly until the floor area is covered, making sure to align the pegs between mat runs.

Protect the STRATA_HEAT Mat with walking boards in areas of high foot traffic and under heavy loads.



Mark out the floor with a permanent marker showing where fixtures and other unheated areas are going to be.

Step 4 - Layout Planning

Before You Begin

A plan of the cable layout is required as part of the control card so that any cutting or drilling after tiling will not result in injury or damage to the STRATA_HEAT™ Wire.

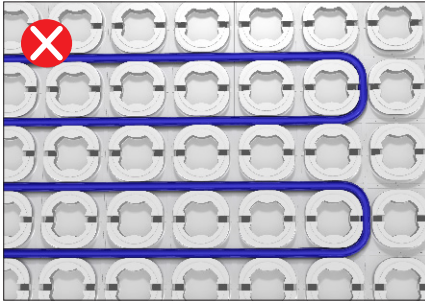

The standard spacing is 3 pegs (3 5/8") (92 mm) between parallel STRATA_HEAT Wire. DO NOT install parallel runs of STRATA_HEAT Wire closer than 3" (76.2 mm) if using cable spacing strips or 2 pegs (2 3/8") (61.2 mm) if using the STRATA_HEAT Mat.

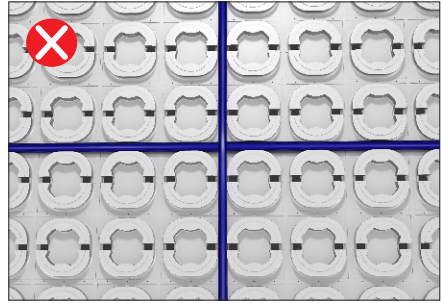

When installing the STRATA_HEAT Wire DO NOT cross the wire over another run, over coldtails or the floor sensor. This will cause overheating and will damage the wire.

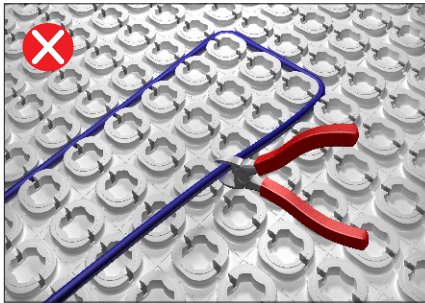

The STRATA_HEAT Wire must not be cut, shortened, extended or left in a void, it must be fully installed within the layer of tile adhesive.



STRATA_HEAT Wire cannot be installed across expansion joints within the floor. Where a heated floor is divided by expansion joints, individual wires should be used to heat each area. The cold tail may cross the expansion joint within a 12" (30 cm) long UL/cUL certified conduit if necessary.

NOTE: The STRATA_HEAT™ Wire should not be installed on irregular surfaces such as stairs or up walls.

NOTE: Ensure the heating cable is at least 8" away from the influence of other heat sources, such as heating and hot water pipes, lighting fixtures or chimneys at all times.

Step 4 - Layout Planning

STRATA_HEAT™ Mat Peg Spacing Diagrams

At a 3 peg spacing the specific heat load of the STRATA_HEAT™ Wire is ~ 13 W/ft². By adjusting the cable spacing, the installation can be customized to suit both the floor coverage and heat load requirements.

When installing the cable using the STRATA_HEAT Wire, maintain a 2 peg (2 3/8") perimeter spacing, between itself and the perimeter or any unheated areas.

2-3 Peg (~ 3") Spacing ~16 W/ft²



Primarily used in areas requiring a rapid heat-up time. The higher heater power will not necessarily lead to more heat output, just a faster heat-up.

3 Peg (3 5/8") Spacing ~13 W/ft²



This is the standard spacing and works best for most projects. It has enough excess power to heat-up quickly, but uses less wire and is more economical.

3-4 Peg (~ 4 1/4") Spacing ~11 W/ft²



4 Peg (4 7/8") Spacing ~10 W/ft²



3-4 or 4 peg spacings are primarily used in areas with lower heat-loss, such as well-insulated homes (Passive Houses). With these lower outputs, it is important to consider the flooring choice so as to reduce the chance of striping (often if the flooring is too thin).

STRATA_HEAT™ Wire 0804 Series is UL certified or listed to the following standards and usage:
(File: E313736)

- UL 1683 "Electric Heating Products For Installation Under Floor Coverings".
- CAN/CSA-C22.2 No. 130-16 "Requirements for Electrical Resistance Trace Heating and Heating Device Sets".

Step 4 - Layout Planning

Wire Spacing Chart

LATICRETE Item #	Cable Length ft	STRATA_HEAT™ Mat			STRATA_HEAT Spacing Strips		AMPS	
		3-2-3 Peg Coverage ft ² (17 W/ft ²)	3 Peg Coverage ft ² (13 W/ft ²) *	4 Peg Coverage ft ² (10 W/ft ²) *	3 Pegs (3"/76mm)	4 Pegs (4"/102mm)		
120 VOLT	0804-0050-2	50	12.5	15	20	12	17	1.6
	0804-0067-2	67	16.5	20	27	17	22	2.2
	0804-0084-2	84	21	25	34	21	28	2.7
	0804-0100-2	100	25	30	40	25	33	3.3
	0804-0133-2	133	33.5	40	53	33	44	4.4
	0804-0166-2	166	41.5	50	67	42	55	5.5
	0804-0200-2	200	50	60	80	50	66	6.5
	0804-0233-2	233	58.5	70	94	58	77	7.7
	0804-0266-2	266	66.5	80	107	66	88	8.8
	0804-0299-2	299	75	90	120	75	100	9.8
	0804-0332-2	332	83.5	100	133	83	111	11.0
	0804-0365-2	365	91.5	110	147	91	122	12.0
	0804-0398-2	398	100	120	160	99	133	13.1
240 VOLT	0804-0083-4	83	21	25	33	21	28	1.4
	0804-0100-4	100	25	30	40	25	33	1.6
	0804-0133-4	133	33.5	40	53	33	44	2.2
	0804-0166-4	166	41.5	50	67	42	55	2.7
	0804-0200-4	200	50	60	80	50	66	3.3
	0804-0233-4	233	58.5	70	94	58	77	3.8
	0804-0266-4	266	66.5	80	107	66	88	4.4
	0804-0299-4	299	75	90	120	75	100	4.9
	0804-0332-4	332	83.5	100	133	83	111	5.5
	0804-0415-4	415	104	125	167	104	138	6.8
	0804-0498-4	498	125	150	200	124	166	8.2
	0804-0581-4	581	146	175	233	145	194	9.6
	0804-0664-4	664	166.5	200	267	166	221	11.0
	0804-0747-4	747	187.5	225	300	187	249	12.3
	0804-0830-4	830	208.5	250	333	207	276	13.5
0804-0403-T	STRATA_HEAT™ Programmable Thermostat							
0804-0404-T	STRATA_HEAT Smart Wifi Thermostat							
0179-0161-H	STRATA_HEAT Mat 161 SQ FT			39.3" X 49' 4 1/2"				
0179-1084-H	STRATA_HEAT Mat 8.6 SQ FT			2'6" x 3'3"				

Step 4 - Layout Planning

Example Installation Diagrams

Standard Room

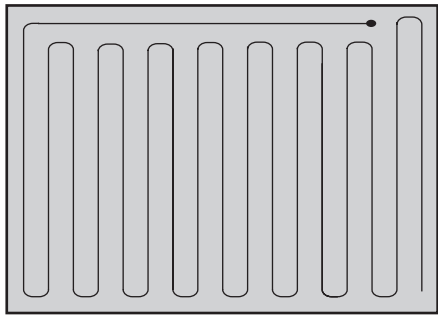

Bathroom

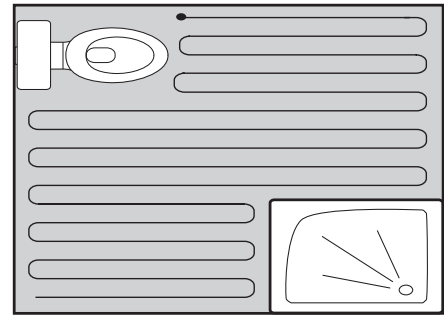

Room with Recesses

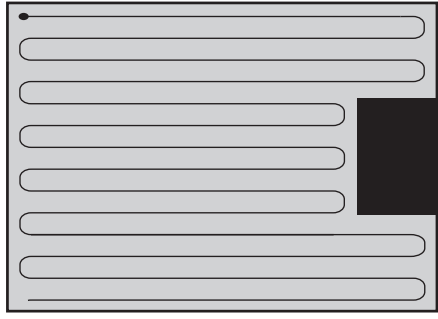

Kitchen

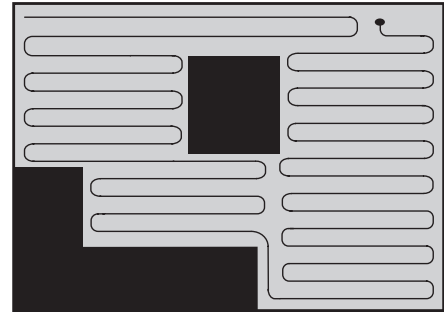

Step 5 - Install STRATA_HEAT™ Wire

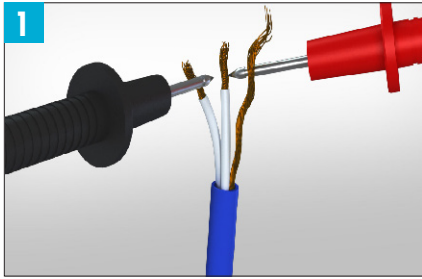

Measure and record the resistance of the STRATA_HEAT™ Wire in the “Resistance Before” column of the control card, supplied as part of this installation guide on Page 32.

Stop installation immediately and contact LATICRETE Technical Services if its resistance falls outside the range set out in the Reference Resistance Band table on Page 35.

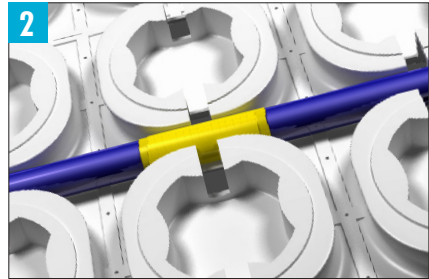

Place the coldtail on the floor, ensuring the section of cable indicating the spliceless location is installed within the STRATA_HEAT Mat.

DO NOT tape over the spliceless connection or STRATA_HEAT Wire. These must be fully embedded within the tile adhesive being laid over.

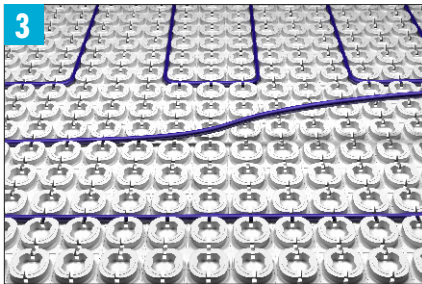

Begin laying the STRATA_HEAT Wire, pressing it between the pegs. Maintain proper spacing and make sure the heating wire doesn't cross itself.

DO NOT install the STRATA_HEAT Wire in ambient temperatures less than 5°F (-15°C).

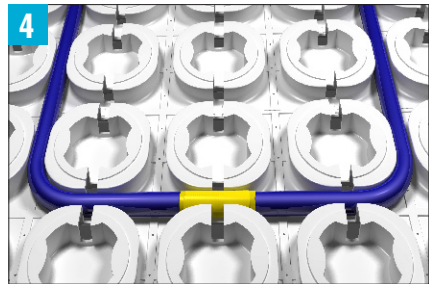

The STRATA_HEAT™ Wire has a marker at its midpoint. When you reach it, review your progress up to that point and check that you are correctly spacing the wire, ensuring that you will have covered the whole of the heated area when you reach the end of the wire.

Step 5 - Install STRATA_HEAT™ Wire

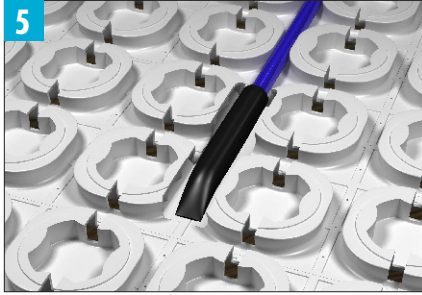

At the end of the STRATA_HEAT™ Wire, you will find a termination joint. To ensure proper fit, the membrane pegs can be cut so that it sits flush, prior to being embedded within the thin-set.

DO NOT tape over the termination joint, it must be in direct contact and fully embedded within the tile adhesive being laid over the STRATA_HEAT Wire.

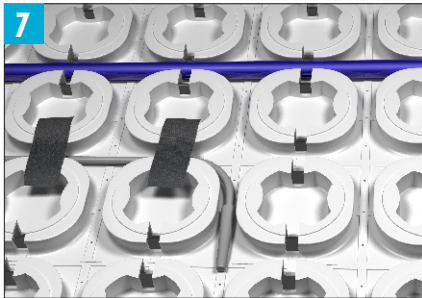

Measure the resistance of the floor sensor and record it on the control card on Page 32. If its resistance is outside the prescribed range contact our technical helpline.

DO NOT tape over the floor sensor tip. It must be in full contact with the heated tile adhesive.

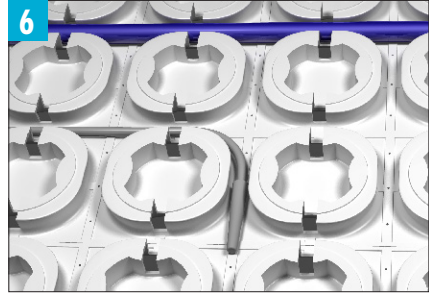

Install the floor sensor at least 6" (15 cm) into the heated area it will be controlling. It should be located centrally between parallel runs of heating cable and not in an area influenced by other heat sources.

If the STRATA_HEAT Wire is installed at multiple spacings, then the sensor should be installed centrally between the narrowest parallel run.

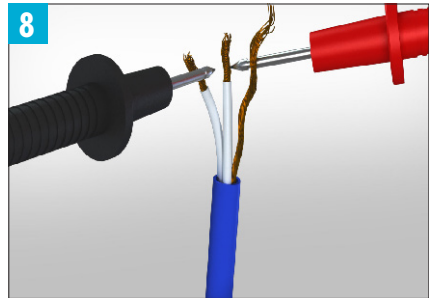

Measure the resistance of the STRATA_HEAT Wire and verify it is still in line with the "Resistance Before" reading previously taken.

Stop installation immediately and contact our technical helpline if its resistance has changed significantly or if it falls outside the range set out in the Reference Resistance Band table on Page 35.

Step 6 - Tiled Floor Covering

Tiled Floor Finish - With HYDRO BAN® Board for Insulation

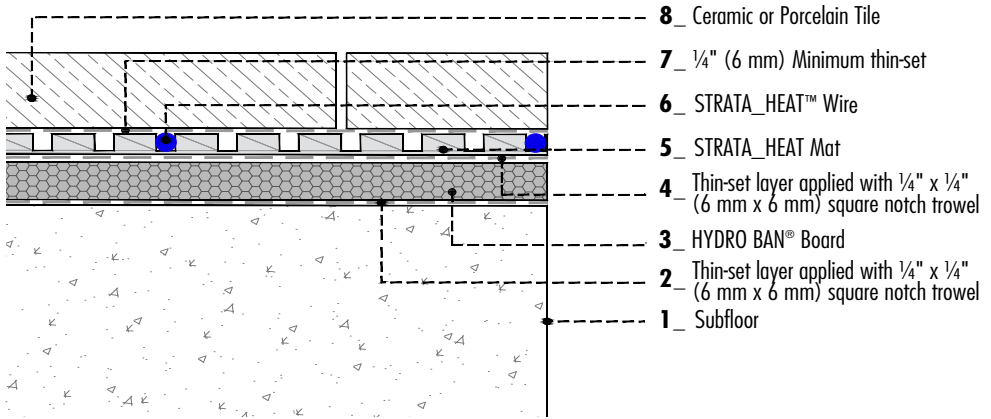

Tiled Floor Finish - Without Insulation Boards

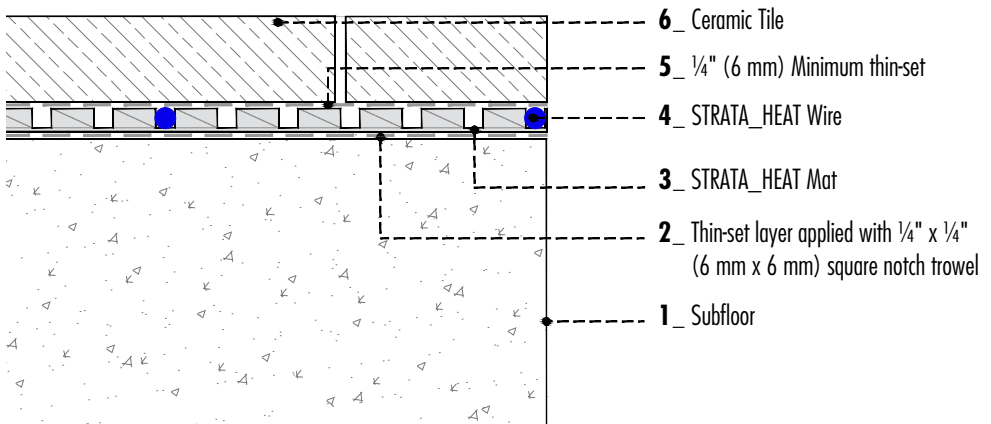

Step 7 - Lay Floor Covering

Underfloor heating performs the most efficiently with conductive, low resistance floor finishes such as stone and tiles. The maximum thermal resistance of the floor must not exceed a thermal insulation "R" value of 1ft °F h/Btu.

Typical "R" Values:

Carpet 1/2" (12 mm) thick = 1.0 * Please check actual values with manufacturer

Stone & Ceramic 1/2" (12 mm) = 0.04

Laminate 1/4" (6 mm) = 0.3

Engineered wood 3/4" (177 mm) = 0.75

Vinyl 1/8" (3 mm) = 0.1

Tiled Floors

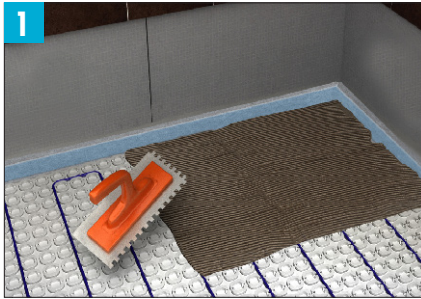

Cover the STRATA_HEAT™ Mat and Wire with a minimum 1/4" (6 mm) full bed of modified thin-set. Take care not to damage or dislodge the STRATA_HEAT™ Wire. Do not install tiles smaller than 3 1/2" (89 mm) in length or width.

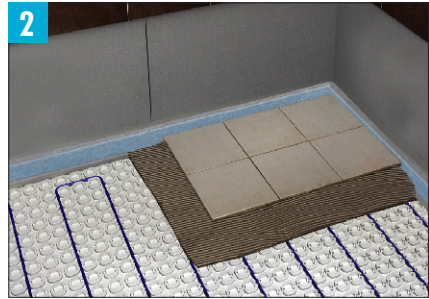

Carefully lay the tiles and press into the adhesive bed.

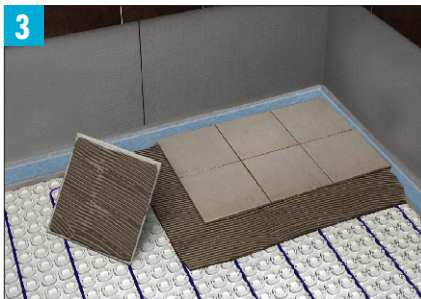

After laying the first tile remove and ensure the tile is getting a full coverage of adhesive from your application.

Ensure the width of the grout line is in line with the manufacturers instructions for the size and type of tile being used. Tiles must not be removed once the adhesive has set, doing so will damage the STRATA_HEAT Wire.

NOTE: Ensure that the tile adhesive used is compatible with underfloor heating and suitable for application onto non porous materials such as the STRATA_HEAT™ Mat.

NOTE: If using tiles smaller than 3 1/2" (89 mm) in length or width, you **MUST** cover the installation with levelling compound first.



Tiled floors can usually be grouted within 24 hours or the next day. DO NOT switch on the STRATA_HEAT Wire until the tile adhesive and grout has fully cured. DO NOT use the STRATA_HEAT Wire to accelerate the drying process of the adhesive.

Step 7 - Lay Floor Covering

Final Steps

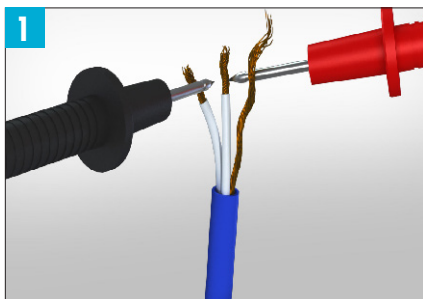

When the tiles have been installed, conduct another resistance test as described on Page 30 to ensure the sensor and STRATA_HEAT Wire have not been damaged and record in the control card on Page 32.



Perimeter strips should be cut flush with the tiles using a utility knife.

Step 8 - Connect the Thermostat

Install the thermostat in accordance with its installation instructions

Instructions for fitting STRATA_HEAT™ Thermostats can be found inside the thermostat box. The UL/cUL certified thermostat must be connected to the main electrical supply via a fuse or circuit breaker in accordance with the National Electrical Code. If the thermostat used is not a STRATA_HEAT Thermostat and does not include a built-in Ground Fault Circuit Interrupter (GFCI), then one must be added to the circuit between the main power supply and the thermostat. If the thermostat does include a GFCI (such as a STRATA_HEAT Thermostat), it is NOT recommended to include another in the circuit, as this is likely to cause nuisance tripping of the GFCI's.

The total load of the STRATA_HEAT Wire must not exceed the thermostat's limit or the amperage rating of the circuit or other control switch without using an appropriately rated contactor/relay. STRATA_HEAT Thermostats have a maximum resistive load rating of 15 Amps.

Ensuring Safety

Install the thermostat within the same room as the STRATA_HEAT Wire. In order to ensure the efficient running of the system within bathrooms, we recommend that the controls are located at least 60" (153 cm) away from shower openings or basin back splash areas so you minimize the possibility of exposure to water.

Typical STRATA_HEAT™ Thermostat Wiring Diagram

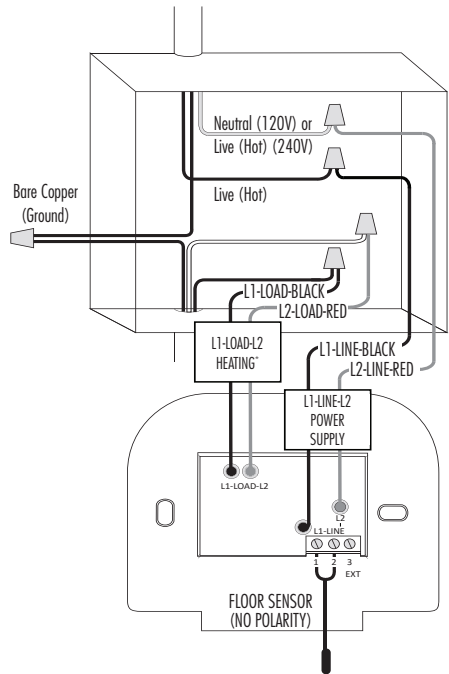

*Undertile heaters are to be installed in parallel across the load terminals of the thermostat or contactor and must not exceed their rated load.

Troubleshooting

HEATING ISSUE 1 - The floor does not heat up

Instructions which are shaded grey must be completed by a qualified electrician

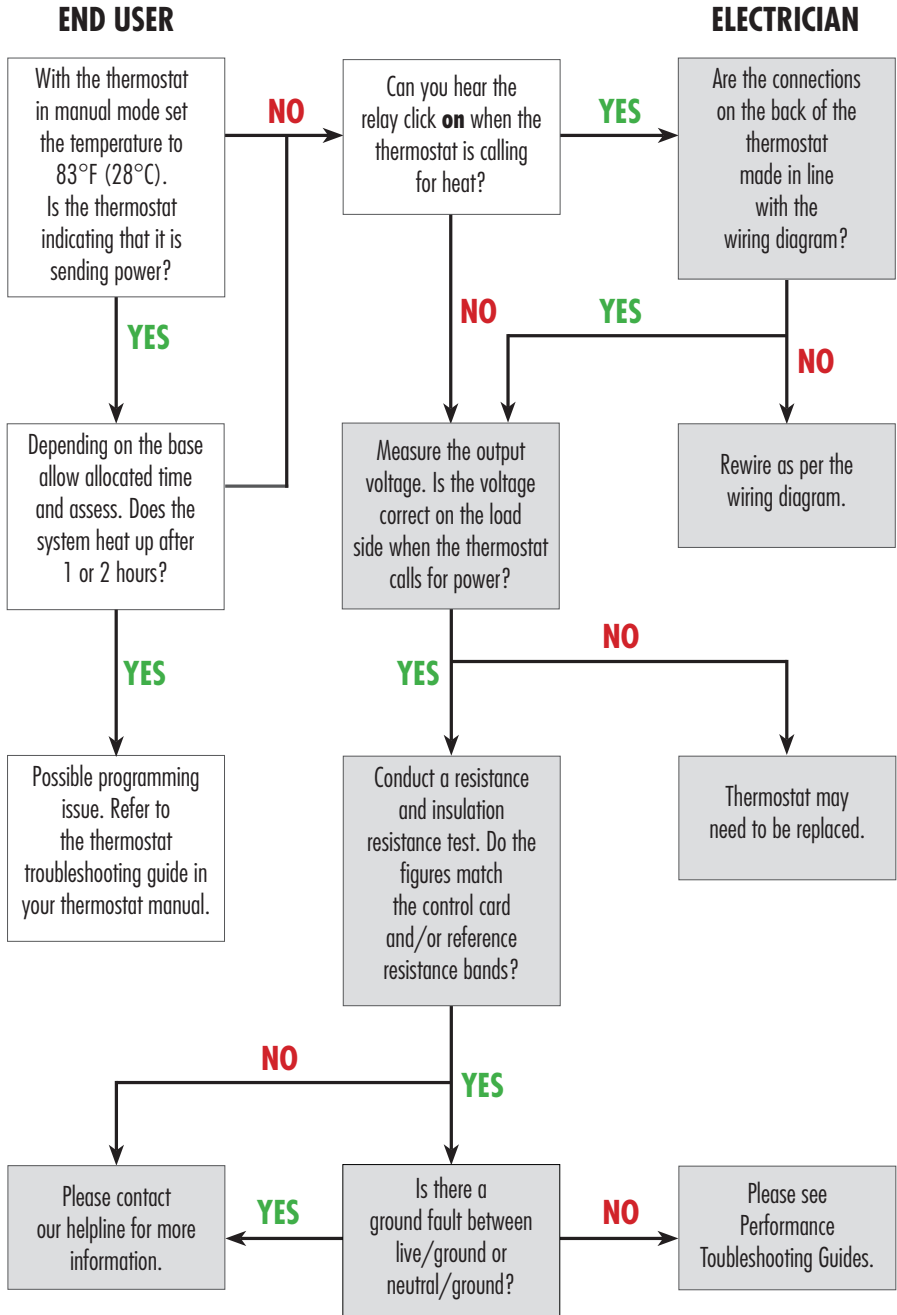

Troubleshooting

HEATING ISSUE 2 - The heater trips the GFCI

Instructions which are shaded grey must be completed by a qualified electrician

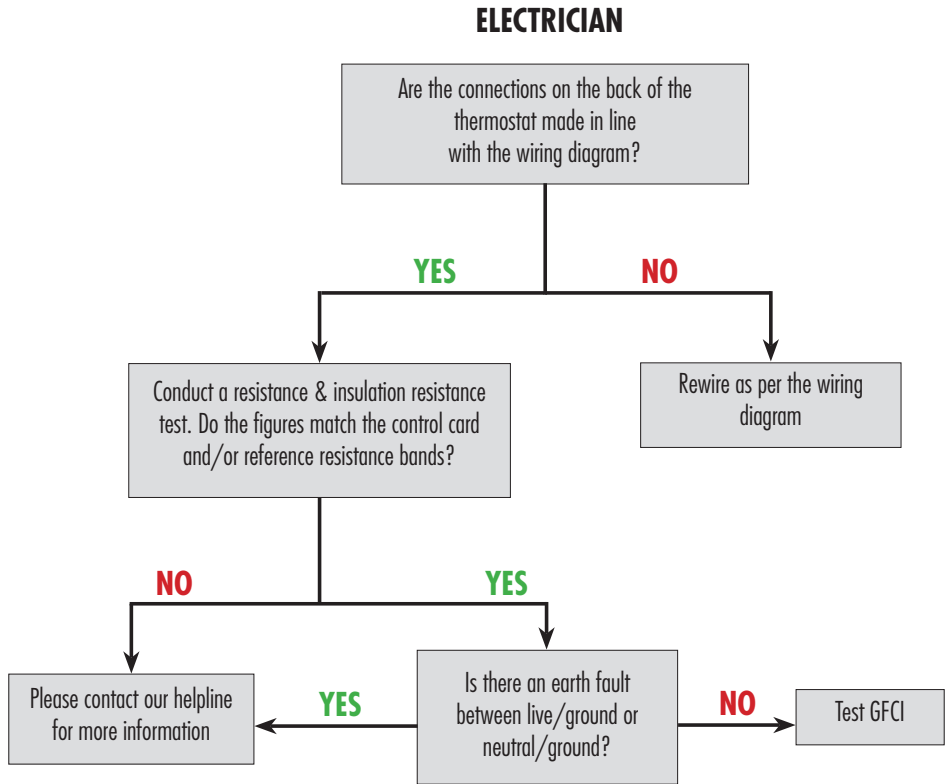

My floor is getting too hot

1. The floor temperature settings on the thermostat may be incorrect.

Check the thermostat settings ensuring that it is controlling the floor surface temperature and that the set target and limiting temperatures are correct.

2. The floor sensor may be poorly positioned, if so the thermostat will be displaying a floor temperature that is not indicative of the floor surface temperature.

Recalibrate the floor sensor in the thermostat settings.

3. The thermostat may be set in regulator mode with the duty cycle set too high.

If the thermostat cannot be set to reference a floor sensor, reduce the regulation value to its minimum selectable value. With the heating active, incrementally increase the setting at an hourly interval until the required floor surface temperature is achieved.

My floor does not get up to temperature

1. Underfloor Heating is normally designed to heat floors to up to 16°F (9°C) above the design room air temperature, which is typically 84°F (29°C). Our hand and foot temperature is normally similar to this, at around 84°- 90°F (29°- 32°C), so the heated floor will feel slightly cooler than touching your own hands together.

If you wish to raise the floor temperature, such that it feels warm, it is permissible to set it up to 27°F (15°C) higher than the design room air temperature. The higher heat output of the floor may overheat the room, making it uncomfortable. The manufacturer of the floor finish should be consulted to ensure compatibility with the chosen temperature before making any changes to the thermostat settings.

2. Refer to points 1, 2 & 3 in the “My floor is getting too hot” above, as each issue can also be the cause of under heating a floor.

3. If the thermostat is controlling the heating using the air temperature, with a floor temperature limit then the floor may be turned off before it reaches its limit.

This is normal as the thermostat is preventing the room air temperature from becoming overheated.

4. The heating system may be uninsulated. If the STRATA_HEAT™ Wire has not been installed over a layer of HYDRO BAN® Boards for insulation, it will be actively heating the subfloor as well as the floor finish. The warm up period of the floor will therefore be slower as the system is heating a much greater mass. It could take several hours if it is installed directly on a thick layer of uninsulated concrete.

If your thermostat has an optimised start feature, ensure it is enabled so that the thermostat can compensate for the mass of the floor. If your thermostat does not have an optimised start feature, measure the time taken for the floor to warm up and adjust the heating start time to compensate.

My floor does not get up to temperature

- 5. The heat output of the installed system may not be sufficient. The system will require a power output of approximately 0.93 W/ft² (10 W/m²) for every degree warmer you require the floor to be than the air. This is in addition to any heat loss downwards through the subfloor.**

If the room air temperature is also lower than desired, supplementary heating may be required to overcome the room heat losses.

If access is available to the underside of the subfloor, installing insulation within the floor will reduce the amount of heat lost through the floor.

- 6. Floor coverings such as carpets, underlays and timber are thermally resistive and will reduce the achievable floor surface temperature. They may also require the floor sensor to be recalibrated.**

Floor finish combinations with a thermal resistance of more than 1.5 tog are not recommended and we recommend that you look to fit a less resistive floor finish. Floor finish combinations with a thermal resistance of more than 2.5 tog are not permitted.

I am getting patchy heat across my floor

- 1. If the subfloor varies across the floor, the amount of heat absorbed by it and lost through it will affect the floor surface temperatures differently above each case.**
- 2. If the floor covering over the underfloor heating changes, each floor finishes characteristics will affect the warm up period and the achievable surface temperature.**
- 3. Hot water pipes under the floor could cause parts of the floor to seem warmer than others.**
- 4. Irregularly spaced wires will cause the floor to be warmer above the closer and cooler where the STRATA_HEAT™ Wire are spaced further apart.**

How to Test the STRATA_HEAT™ Wire and Floor Sensors

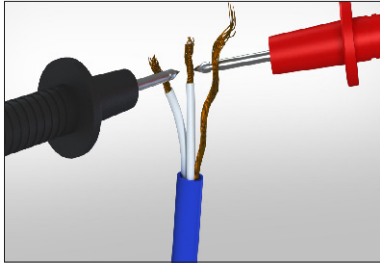

The STRATA_HEAT™ Wire and floor sensors must be tested before they are laid, once they have been laid but before the tiles have been laid and again before they are connected to the thermostat. The resistance (ohms) of each heater should be measured. You should carry out the following tests and should expect the results detailed below:

Heating Cable Resistance Test

Set a multimeter or ohmmeter to 200 ohm to record resistance. If 200 ohm is not available, a range of 0-500 ohms is acceptable. Measure the resistance across the heating conductors. Ensure the measured resistance is within the Reference Resistance Band shown on Page 34 for the cable size being tested.

Record the readings on the control card on Page 31 in line with the installation procedure.

Ground Fault Check

Set a multimeter or ohmmeter to record resistance in the range of $200M\Omega$ or greater if available. Measure the resistance across the heating conductors and the ground braid.

Ensure the measured resistance is showing as greater than $200M\Omega$ or infinite if the meter cannot read this high.

Insulation Resistance Test

Set an insulation resistance tester to 500VDC. Measure the resistance across the heating conductors and ground (braid) wire.

Ensure the measured resistance is showing greater than $200M\Omega$ to indicate a pass.

NOTE: Due to the high resistance of the heating element, it may not be possible to get a continuity reading from the STRATA_HEAT Wire and as such, continuity testers are not recommended. When checking resistance, make sure your hands do not touch the meter's probes as the measurement will include your internal body resistance and render the measurement inaccurate. If you do not get the expected results or at any time you believe there may be a problem, please contact our helpline for guidance.

Floor Sensor

Ensure that the floor sensor is tested before the final floor finish has been laid. The floor sensor values can be found in the STRATA_HEAT Thermostat instructions. When testing the floor sensor ensure that the meter can read up to $20K\Omega$. STRATA_HEAT Thermostats use a $10K\Omega$ floor sensor @ $77^{\circ}F$ ($25^{\circ}C$). For temperatures between $68^{\circ}F$ ($20^{\circ}C$) and $86^{\circ}F$ ($30^{\circ}C$) the resistance of the floor sensor should measure between $8K\Omega$ and $12K\Omega$.

Layout Plan

NOTE: For future reference, draw a plan showing the layout and location of the STRATA_HEAT™ Wire.

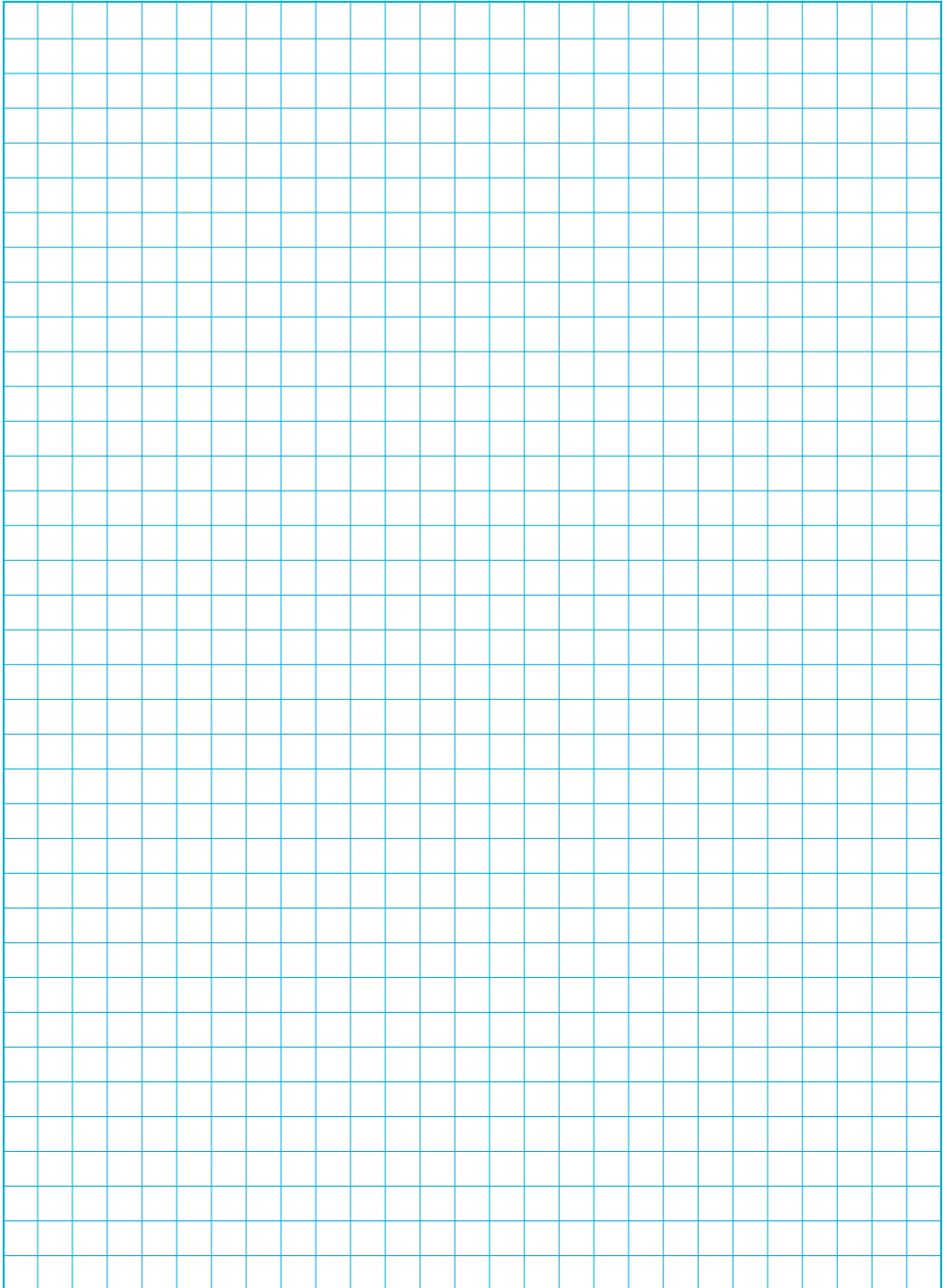

Control Card

Heater Location

.....

.....

Total Wattage

.....

WARNING

**Radiant Floor Heating Systems -
Risk of electric shock**



Electric-wiring and heating panels contained within the floor.
DO NOT penetrate with nails, screws, or similar devices.
DO NOT restrict the thermal emission of the heated floor.

ATTENTION:

DO NOT cut or shorten the heating element.

Ensure that the entire heating element(s) including the joints are installed within the layer of tile adhesive.

DO NOT tape over the joints or STRATA_HEAT™ Wire as this may insulate them, causing them to fail.

The heating element must be used in conjunction with a GFCI.

Heater Model	Resistance Before	Resistance After	Insulation Resistance (Pass)	Floor Sensor Resistance

Date _____ Signature _____

Company stamp/name _____

LATICRETE offers a comprehensive 100% labor and materials warranty for tile and stone installations that uses our system of products.

- The most comprehensive assortment of tile and stone installation materials available for virtually any tile or stone application around the world
- LATICRETE® warranties cover any suitable tile or stone manufacturer's product, allowing you to select the appropriate product and finish you desire for your project with confidence
- Customizable warranties are available to suit your specific project requirements

CERTIFICATIONS

LATICRETE materials are certified by independent laboratories throughout the world to meet or exceed applicable industry standards/norms, including: DIN, EN, ANSI, AS, ISO, UEATC, JIS, ASTM, ABSAC, and UPC® IAPMO and the ICC.



* See DS-230.99 for complete warranty information

Technical Specifications

TECHNICAL SPECIFICATIONS - STRATA_HEAT™ Mat

THICKNESS	1/4" (6 mm)
COMPOSITION	POLYPROPYLENE MEMBRANE AND FLEECE BACKING
COLOUR	White
SPACING	3 5/8" (92 mm) & 4 7/8" (124 mm)
SIZE	2'6" x 3'3" (770 mm x 985 mm) sheet 46'7" x 3'3" (14,200 mm x 985 mm) roll

TECHNICAL SPECIFICATIONS - STRATA_HEAT Wire

OPERATING VOLTAGE	120V and 240V: 60Hz
COLOUR	Blue
THICKNESS	3/16" (4.5 mm)
OUTPUT RATING	13.3W/ft ² (143 W/m ²) (3 Pegs - 3 5/8" / 92 mm)
INNER INSULATION	ECTFE
OUTER INSULATION	PVC
MIN. TEMPERATURE INSTALLATION	5°F (-15°C)
CONNECTION	10 ft (3 m) "COLDTAIL" CONNECTION

OPTIONAL PERIMETER STRIP

POLYETHYLENE FOAM	(H) 1 1/8" (29 mm) x (T) 3/8" (10 mm)
-------------------	---------------------------------------

Certifications

STRATA_HEAT™ Wire 0804 Series are certified or listed to the following standards and usage:

UL 1683 "Electrical Heating Products for Installation Under Floor Coverings".

CAN/CSA C22.2 No. 130-16 "Requirements for Electrical Resistance Trace Heating and Heating Device Sets".

STRATA_HEAT Thermostats; Model Nos. 0804-0403-T, 0802-0404-T are tested to the following standards:

- Automatic Electrical Controls - Part 1: General Requirements [UL 60730-1]; [CSA E60730-1]
- UL Standard For Safety For Automatic Electrical Controls For Household And Similar Use – Part 2-9: Particular Requirements For Temperature Sensing Controls [UL 60730-2-9]; [CSA E60730-2-9]
- Ground-Fault Circuit-Interrupters [UL 943]; [CSAC22.2#144.1]

Technical Specifications

STRATA_HEAT™ Wire Size Guide

STRATA_HEAT™ Wire						Reference Resistance Bands (Ω)
LATICRET Item	Heated Area ft (m) ² 3 5/8" (92 mm) Spacing	Power (W)	Load (A)	Resistance (Ω)		
120 VOLT	0804-0050-2	15 (1.39)	195	1.6	73.8	70.2-81.2
	0804-0067-2	20 (1.86)	260	2.2	55.4	52.6-60.9
	0804-0084-2	25 (2.32)	325	2.7	44.3	42.1-48.7
	0804-0100-2	30 (2.79)	390	3.3	36.9	35.1-40.6
	0804-0133-2	40 (3.72)	525	4.4	27.4	26.1-30.2
	0804-0166-2	50 (4.64)	655	5.5	22.0	20.9-24.2
	0804-0200-2	60 (5.57)	785	6.5	18.3	17.4-20.2
	0804-0233-2	70 (6.50)	920	7.7	15.6	14.9-17.2
	0804-0266-2	80 (7.43)	1050	8.8	13.7	13.0-15.1
	0804-0299-2	90 (8.36)	1180	9.8	12.2	11.6-13.4
	0804-0332-2	100 (9.29)	1315	11.0	11.0	10.4-12.0
	0804-0365-2	110 (10.22)	1445	12.0	10.0	9.5-11.0
	0804-0398-2	120 (11.15)	1575	13.1	9.1	8.7-10.1
	240 VOLT	0804-0083-4	25 (2.32)	325	1.4	177.2
0804-0100-4		30 (2.79)	390	1.6	147.7	140.3-162.5
0804-0133-4		40 (3.72)	525	2.2	109.7	104.2-120.7
0804-0166-4		50 (4.64)	655	2.7	87.9	83.5-96.7
0804-0200-4		60 (5.57)	785	3.3	73.4	69.7-80.7
0804-0233-4		70 (6.50)	920	3.8	62.6	59.5-68.9
0804-0266-4		80 (7.43)	1050	4.4	54.9	52.2-60.4
0804-0299-4		90 (8.36)	1180	4.9	48.8	46.4-53.7
0804-0332-4		100 (9.29)	1310	5.5	44	41.8-48.4
0804-0415-4		125 (11.61)	1640	6.8	35.1	33.3-38.6
0804-0498-4		150 (13.94)	1970	8.2	29.2	27.7-32.1
0804-0581-4		175 (16.26)	2300	9.6	25.0	23.8-27.5
0804-0664-4		200 (18.58)	2630	11.0	21.9	20.8-24.1
0804-0747-4		225 (20.90)	2955	12.3	19.5	18.5-21.5
0804-0830-4	250 (23.23)	3240	13.5	17.8	16.9-19.6	

NOTE: STRATA_HEAT™ Thermostats use a 10K floor sensor. The expected resistance is: 10K at 77°F (25°C), 12.1K at 68°F (20°C), 14.7K at 59°F (15°C).

Subfloor Considerations

Spacing Strips

Concrete Subfloors

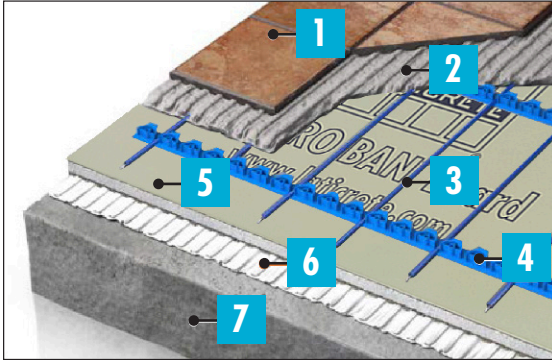

CONCRETE SUBFLOOR (Recommended)

- 1 Floor Finish
- 2 3/8" (10 mm) Minimum Thin-set or levelling compound
- 3 STRATA_HEAT™ Wire
- 4 STRATA_HEAT Spacing Strips
- 5 HYDRO BAN® Board
- 6 Thin-set layer applied with 1/4" x 1/4" (6 mm x 6 mm) square notch trowel
- 7 Subfloor

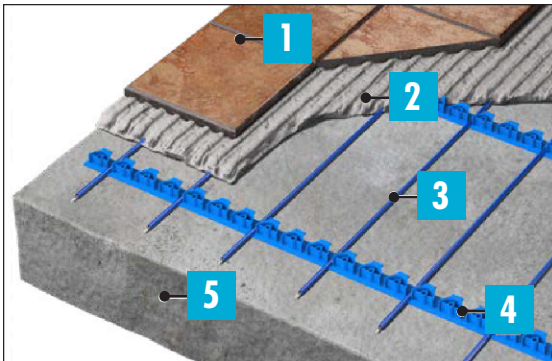

CONCRETE SUBFLOOR

- 1 Floor Finish
- 2 3/8" (10 mm) Minimum Thin-set or levelling compound
- 3 STRATA_HEAT Wire
- 4 STRATA_HEAT Spacing Strips
- 5 Subfloor

It is recommended that you use HYDRO BAN Boards beneath the STRATA_HEAT™ system for optimum performance. The insulation will improve the systems response to heating demand, saving energy and reducing running costs.

Where expansion joints are present in the subfloor, these must be preserved up through all covering layers, including insulation (where installed) and STRATA_HEAT system.

Subfloor Considerations

Spacing Strips

Timber Subfloors

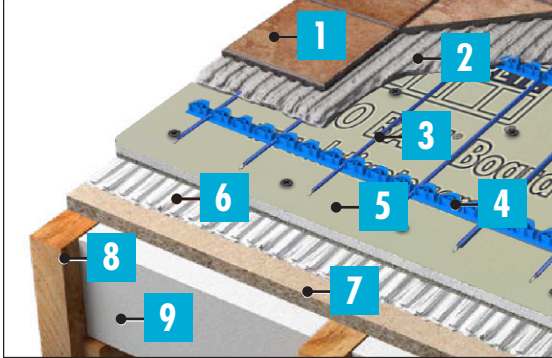

TIMBER SUBFLOOR (Recommended)

- 1 Floor Finish
- 2 3/8" (10 mm) Minimum Thin-set or levelling compound
- 3 STRATA_HEAT Wire
- 4 STRATA_HEAT Spacing Strips
- 5 HYDRO BAN Board
- 6 Thin-set layer applied with 1/4" x 1/4" (6 mm x 6 mm) square notch trowel
- 7 Subfloor
- 8 Joists
- 9 Insulation

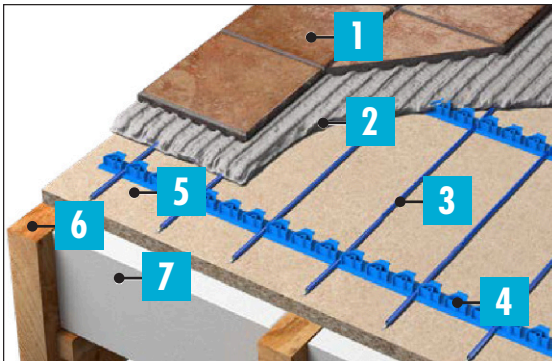

TIMBER SUBFLOOR

- 1 Floor Finish
- 2 3/8" (10 mm) Minimum Thin-set or levelling compound
- 3 STRATA_HEAT Wire
- 4 STRATA_HEAT Spacing Strips
- 5 Subfloor
- 6 Joist
- 7 Insulation

Alternate Installation - **Installing Using Spacing Strips**

When using the 12" (30.5 cm) spacing strips to secure the wire to the subfloor, use the following provisions to ensure proper spacing of the wire. The spacing strips included in the kit are 12" (30.5 cm) long with 1" (2.5 cm) spacing guides.

The perimeter spacing strips should be installed a minimum of 3" (7.6 cm) away from the wall, perpendicular to the planned wire runs. (Additional stabilizing guides could be laid 40" (102 cm) apart across the floor). The spacing strips can be secured to the floor using suitable adhesive, nails, screws or strong double-sided tape.

It may be necessary to cut the guides into smaller sections to accommodate irregular shaped rooms.

Once you have fitted the spacing strips, the heating wire may be laid out.

Installing the STRATA_HEAT™ Wire

Before you start laying the STRATA_HEAT™ Wire ensure that the heating wire(s) are tested. After 10 feet (304.8 cm) of coldtail has been removed, you will reach the spliceless connection, at which point the unheated section of cable (coldtail) becomes the heating cable. This will be indicated with a <SPLICE> label.

You may tape the coldtail to the floor. DO NOT tape over the spliceless connection however as this may create air pockets resulting in failure. The connection must be installed under the floor covering and covered with 3/8" (10 mm) thinset or self-levelling underlayment from the top of the floor deck. Under no circumstances should the spliceless connection or the heated wire be installed within the conduit, only the coldtail should occupy the UL/cUL certified conduit. DO NOT bend the spliceless connection.

Install the heating wire as per the installation plan. The heating wire should be laid in parallel lines back and forth across the main body of the area to be heated. Use the spacing guide on page 17 to space the wire. The standard spacing is 3" (76.2 mm) if using STRATA_HEAT Spacing Strips or 3 pgs (3 5/8") (92 mm) if using the STRATA_HEAT Mat.

Ensure that the wire is held in place by the spacing strips and that you maintain moderate tension on the wire to prevent it from lifting during the installation of the final floor covering. Using duct tape secure the end of the wire to the floor. DO NOT cover the factory end joint in tape as air pockets may cause the end joint to overheat.

Installing the floor sensor

The floor sensor is used for temperature regulation of the floor surface. The end of the probe wire contains a capped sensor that should be centred between two STRATA_HEAT Wires at least 12" (30.5 cm) into the heated area.

The sensor wire **MUST NOT** touch or cross over the heating wires. Depending on the requirements of the tiler, it may be necessary to chisel out short channels in the subfloor to minimize the increased height presented by the floor probe. Before chiseling the area, ensure that the heating wire, unheated lead and floor probe are protected to avoid damage during chiseling. Place the floor probe into the channels and secure with fixing tape. **DO NOT** tape over the floor sensor tip.

NOTE: DO NOT run the cold lead wires and the floor sensor in the same UL/CUL certified conduit.

IMPORTANT - Test the wire and floor sensor

Before installing the final floor finish ensure that the wire(s) and floor sensor is working properly using the method described on page 30.



Technical helpline: +1-203-393-0010 Ext 1235



LATICRETE International, Inc. ■ One LATICRETE Park North, Bethany, CT 06524-3423 USA
1.800.243.4788 ■ +1.203.393.0010 ■ www.laticrete.com

DS-044.6-1120 ©2020 LATICRETE International, Inc. All trademarks shown are the intellectual properties of their respective owners.