

MK-212 SERIES OWNER'S MANUAL

MODELS	PART #
MK-212-4	159414
MK-212-4-SPCL	159414-SPCL
MK-212-6	167882



MK-212-4
Part # 159414



MK-212-6
Part # 167882

Revision 309	03.2019
Manual Part No. 159862	

Caution: Read all safety and operating instructions before using this equipment. This owners manual **MUST** accompany the equipment at all times.

We at MK Diamond want to congratulate you on selecting the MK-212 Saw. We are certain that you will be pleased with your purchase. MK Diamond takes pride in producing the finest products in the industry.

Operated correctly, your MK-212 Saw should provide you with years of quality service. In order to help you, we have included this manual. This owners manual contains information necessary to operate and maintain your MK-212 Saw safely and correctly. Please take a few minutes to familiarize yourself with the MK-212 Saw by reading and reviewing this manual.

If you should have questions concerning your MK-212 Saw, please feel free to call our friendly customer service department at: 800 421-5830

Regards,

MK Diamond

NOTE THIS INFORMATION FOR FUTURE USE:

MODEL NUMBER:	
SERIAL NUMBER:	
PURCHASE PLACE:	
PURCHASE DATE:	

WARRANTY: For your (1) one year warranty to be effective, complete the online Product Registration as soon as possible. Visit www.mkdiamond.com/registration/

	Page
SAFETY	
Safety Message/Alert Symbols, Warnings	4
Hazard Symbols	5
General, Maintenance, Saw Safety	6-7
California Proposition 65 Warning	8
Electrical Requirements and Grounding Instructions	9-12
Lock Out Method	12
Safety Label Locations	13
PRODUCT SPECIFICATIONS	
Product Specifications	14
Unpacking, Contents, and Transport	15
SETUP, ADJUSTMENT AND OPERATION	
Setup / Assembly	16
Diamond Blade Installation	17-19
Pre-start Inspection	19
Water Pump	20-21
Cord Setup	21
90° Straight Edge Cuts	22
Angle Cuts	23
Off-Angle Cuts	24
MAINTENANCE	
Cleanup	25
Maintenance	26
Monthly Maintenance	27
Flow Adjustment	28
Diamond Blade Change Out	28-30
Table Removal	30
Cutting Head Alignment	31
Troubleshooting	32-34
ACCESSORIES	
Accessories	35
ORDERING AND RETURNING INSTRUCTIONS	
Ordering, Return Policy, Packaging, and Authorized Service Center	36
CONTACT AND LIMITED WARRANTY	
Contact and Limited Warranty	37

Read and follow all safety, operating and maintenance instructions. Failure to read and follow these instructions could result in injury or death to you or others. Failure to read and follow these instructions could also result in damage and/or reduced equipment life. Safety warnings and guidelines do not by themselves eliminate danger. They are not substitutes for proper accident prevention procedures and good judgement.

SAFETY MESSAGES

A safety message alerts you to potential hazards that could hurt you or others. Each safety message is preceded by a safety alert symbol () and one of three words: **DANGER**, **WARNING**, or **CAUTION**.



DANGER You **WILL** be **KILLED** or **SERIOUSLY INJURED** if you **DO NOT** follow directions.



WARNING You **CAN** be **KILLED** or **SERIOUSLY INJURED** if you **DO NOT** follow directions.



CAUTION You **CAN** be **INJURED** if you **DO NOT** follow directions. It may also be used to alert against unsafe practices.

DAMAGE PREVENTION AND INFORMATION MESSAGES

A Damage Prevention Message is to inform the user of important information and/or instructions that could lead to equipment or other property damage if not followed. Information Messages convey information that pertains to the equipment being used. Each message will be preceded by the word **NOTE**, as in the example below.

NOTE: Equipment and/or property damage may result if these instructions are not followed.

GENERAL SAFETY PRECAUTIONS AND HAZARD SYMBOLS

In order to prevent injury, the following safety precautions and symbols should be followed at all times!



ALWAYS read this Owner's Manual before operating the machine. **DO NOT** operate or service this equipment before reading this entire manual. Read and understand all warnings, instructions and controls on the machine. Know how to stop the equipment quickly in case of emergency. It is the operators responsibility to use this machine under safe working conditions and conform with federal, state and local codes or regulations pertaining to safety, air, pollution, noise etc...



ALWAYS keep the Blade and Belt Guards in place. **DO NOT** operate this machine with any guard or safety device removed. A Guard, or any damaged part should be repaired or replaced immediately.



NEVER operate this equipment without proper protective clothing, shatterproof glasses, steel-toed boots and other protective devices required by the job. Non-slip foot wear is recommended.

**PERSONAL PROTECTIVE EQUIPMENT**

ALWAYS wear approved respiratory, head, ear and eye protection when operating this machine.

**ACCIDENTAL STARTS!**

Before starting the engine/motor, be sure the **ON/OFF** switch is in the **OFF** position to prevent accidental starting. Place the **ON/OFF** switch in the **OFF** position before performing any service operation. **ALWAYS** place the power **ON/OFF** switch in the **OFF** position when the machine is not in use.

**ROTATING PARTS**

Keep hands, feet, hair, and clothing away from all moving parts to prevent injury. Never operate the motor with covers, shrouds, or guards, removed.

**HOT PARTS!**

Engine components can become extremely hot from operation. To prevent severe burns, do not touch these areas while the engine is running, or immediately after it is turned off. Never operate the engine with heat shields removed.

**OVER SPEED**

NEVER tamper with the governor components or settings to increase the maximum speed. Severe personal injury and damage to the engine or equipment can result if operated at speeds above maximum.

**ELECTRICAL SHOCK**

NEVER touch electrical wires or components while the engine is running. Exposed, frayed or worn electrical wiring and plugs can be sources of electrical shock which could cause severe injury or burns. Do not touch the plug with wet hands.



ALWAYS avoid inhalation of and skin contact with silica dust and/or mist. Provide proper dust removal. Use dust-collection system when applicable.



NEVER operate the machine in an explosive atmosphere or near combustible materials. Sparks from the cutting-action of this machine can ignite flammable materials, liquids, gases or dust.



This equipment should not be operated by persons under 18 years of age.

**KEEP CHILDREN AWAY**

All visitors and children should be kept a safe distance from work area. Maintain a safe operating distance to other personnel.

**MAKE THE WORKSHOP KID PROOF**

Make the workshops kid proof by using padlocks, master switches or by removing starter keys.

**DO NOT FORCE THE TOOL**

A power tool will do a job better and safer operating at the rate for which it was designed. **DO NOT** force a tool or an attachment to do a job that it was not designed to do.

**USE PROPER APPAREL**

DO NOT wear loose clothing, gloves, neckties, rings, bracelets, or other jewelry that may be caught in moving parts. Non-slip footwear is recommended. Wear protective hair covering to contain long hair.

**SECURE WORK**

Clamps or a vise should be used to hold work whenever practical. Keeping your hands free to operate a power tool is safer.

**DO NOT OVERREACH**

Keep proper footing and balance at all times by not overreaching.

**DISCONNECT TOOLS**

Power tools should always be disconnected before servicing, adjusting or when changing accessories, such as blades, bits, cutters, and the like.

**MAINTAIN TOOLS WITH CARE**

Keep tools clean and maintained for the best and safest performance. Always follow maintenance instructions and examine the machine before use. If any abnormal vibrations or noises occurs, turn off machine immediately and have the problem corrected before further use.

**REMOVE ADJUSTING KEYS AND WRENCHES**

Form a habit of checking to see that keys and adjusting wrenches are removed from the power tool before it is turned on.

**KEEP WORK AREA CLEAN**

Cluttered work areas and benches invite accidents. Keep area around machine clear of obstructions which could cause persons to fall.

**DO NOT USE IN DANGEROUS PLACES**

DO NOT operate equipment in dangerous or hazardous environments. **DO NOT** use power tools in damp or wet locations nor expose them to rain. Always keep the work area well lighted.

**USE RECOMMENDED ACCESSORIES**

Consult the owner's manual for recommended accessories. Using improper accessories may increase the risk of personal or by-stander injury. Unauthorized equipment modifications will void all warranties. Manufacturer does not assume responsibility for any accident due to equipment modifications.



ALWAYS ensure that the machine is on level ground before using.

**NEVER STAND ON THE TOOL**

Serious injury could occur if a power tool is tipped, or if a cutting tool is unintentionally contacted.

**TRANSPORT**

When loading or unloading the machine, use caution. Remove the blade prior to hoisting, loading and transporting the machine.

**CHECK FOR DAMAGED PARTS**

Before using a power tool, check for damaged parts. A guard or any other part that is damaged should be carefully checked to determine if it would operate properly and perform its intended function. Always check moving parts for proper alignment or binding. Check for broken parts and mountings and all other conditions that may affect the operation of the power tool. A guard, or any damaged part, should be properly repaired or replaced. Always check the machine for loose bolts before starting.

**DIRECTION OF ROTATION**

A blade or cutter should always be installed so that rotation is in the direction of the arrow imprinted on the side of the blade or cutter. It should correspond with the rotational direction of the motor. Always feed work into a blade against the direction of rotation.

**NEVER LEAVE A TOOL UNATTENDED**

TURN POWER OFF - Do not leave a tool until it comes to a complete stop. **ALWAYS** turn a power tool **OFF** when leaving the work area, or, when a cut is finished.



NEVER disconnect any "emergency or safety devices". These devices are intended for operator safety. Disconnection of these devices can cause severe injury, bodily harm, or even death! Disconnection of any of these devices will void all warranties. Unauthorized equipment modifications will void all warranties. Manufacturer does not assume responsibility for any accident due to equipment modifications.



NEVER use this machine with any cutter designed for woodworking.



NEVER operate this equipment when not feeling well due to fatigue, illness or taking medicine.



NEVER operate this equipment under the influence of drugs or alcohol.



On belt driven equipment, overtensioning of belts will result in premature crank and/or bearing failure.



Whenever necessary, replace nameplate, operation and safety decals when they become difficult to read.



ALWAYS store equipment properly when it is not being used. Equipment should be stored in a clean, dry location out of the reach of children



DO NOT lend or rent this equipment without including the Owner's Manual and the Engine/Motor Manufacturer's Manual.



Check the chemical properties of the material to be cut/grinded and follow all EPA/OSHA Regulations. (cut/ground)

SILICA DUST WARNING

Grinding/cutting/drilling of masonry, concrete, metal and other materials with silica in their composition may give off dust or mists containing crystalline silica. Silica is a basic component of sand, quartz, brick clay, granite and numerous other minerals and rocks. Repeated and/or substantial inhalation of airborne crystalline silica can cause serious or fatal respiratory diseases, including silicosis. In addition, California and some other authorities have listed respirable crystalline silica as a substance known to cause cancer. When cutting such materials, always follow respiratory precautions.

Use appropriate NIOSH-approved respiratory protection where dust hazard may occur. Paper masks or surgical masks without a NIOSH approval number are not recommended because they do little to protect the worker. For more information about respirator programs, including what respirators have received NIOSH approval as safe and effective, please visit the NIOSH website at:
<http://www.cdc.gov/niosh/topics/respirators>

Observe OSHA regulations for respirator use (29 C.F.R. §1910.134).
Visit <http://www.osha.gov> for more information.

CALIFORNIA PROPOSITION 65 MESSAGE

Some dust created by power sanding, sawing, grinding, drilling, and other construction activities contain chemicals known (to the State of California) to cause cancer, birth defects or other reproductive harm. Some examples of these chemicals are:

- Lead, from lead-based paints
- Crystalline silica, from bricks and cement and other masonry products
- Arsenic and chromium, from chemically treated lumber

For further information, consult the following sources:
<http://www.osha.gov/dsg/topics/silicacrystalline/index.html>
<http://www.cdc.gov/niosh/docs/96-112/>
<http://oehha.ca.gov/prop65/law/P65law72003.html>
<http://www.dir.ca.gov/Title8/sub4.html>
<http://www.P65warnings.ca.gov>

Your risk from these exposures varies depending on how often you do this type of work. To reduce your exposure to these chemicals, work in a well-ventilated area, and work with approved safety equipment, such as dust masks that are specially designed to filter out microscopic particles. Where use of a dust extraction device is possible, it should be used. To achieve a high level of dust collection, use an industrial HEPA vacuum cleaner. Observe OSHA 29 CFR part 1926.57 and 1926.103.

ELECTRICAL REQUIREMENTS AND GROUNDING INSTRUCTIONS

In order to prevent electrical shock and injury, the following electrical safety precautions and symbols should be followed at all times!



WARNING

In case of a malfunction or breakdown, grounding provides a path of least resistance for electrical current to reduce the risk of electric shock. This tool is equipped with an electric cord which has an equipment-grounding conductor and a grounding plug. The plug must be plugged into a matching outlet that is properly installed and grounded in accordance with all local codes and ordinances.

- **DO NOT** modify the plug provided - if it will not fit the outlet, have the proper outlet installed by a qualified electrician.
- Improper connections of the equipment-grounding conductor can result in a risk of electric shock. The equipment-grounding conductor is the insulated conductor that has an outer surface that is green, with or without yellow stripes. If repair or replacement of the electric cord or plug is necessary, **DO NOT** connect the equipment-grounding conductor to a live terminal.
- Check with a qualified electrician or service personnel if the grounding instructions are not completely understood, or if in doubt as to whether the tool is properly grounded.
- Use only 3-wire extension cords that have 3-prong grounding plugs and 3-pole receptacles that accept the tool's plug.
- Repair or replace a damaged or worn cord immediately.

This tool is intended for use on a circuit that has an outlet that looks like the one shown in Sketch A. The tool has a grounding plug that looks like the plug illustrated in Sketch A. A temporary adapter, which looks like the adapter illustrated in sketches B and C, may be used to connect this plug to a 2-pole receptacle as shown in Sketch B, if a properly grounded outlet is not available. The temporary adapter should be used only until a properly grounded outlet can be installed by a qualified electrician. The green-colored rigid ear, plug, and the like, extending from the adapter, must be connected to a permanent ground, such as a properly grounded outlet box.

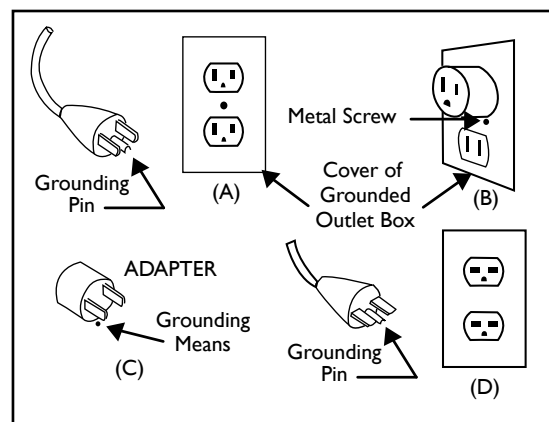

Circuit and Adapter Information

NOTE: Use of a temporary adapter is not permitted in Canada.

NOTE: If permanently connected this tool should be connected to a grounded metal permanent wiring system; or to a system having an equipment - grounding conductor.

ELECTRIC MOTOR SAFETY

For maintenance care and operation of the electric motor, refer to your electric motor instruction booklet furnished with the electric motor. Protect the electric motor from dust as much as possible and keep ventilating openings clean. Before plugging in the machine, make sure that the outlet voltage is within the voltage marked on the machines's data plate.

**CAUTION**

DO NOT spray water on the electric motor. **DO NOT** touch the plug with wet hands. To reduce the risk of electrocution, keep all connections dry and off the ground.



DO NOT operate electric motor in an explosive environment.

**DO NOT EXPOSE TO RAIN**

DO NOT expose to rain or use in damp locations.

**WARNING**

If operating the equipment in damp locations is unavoidable, **ALWAYS** use a Ground Fault Circuit Interrupter, **ALWAYS** wear rubber gloves and footwear in damp conditions.



DO NOT abuse the cord. Never use the cord to carry the equipment or to pull the plug from the outlet. Keep the cord away from heat, sharp edges, and moving parts. Replace damaged cords immediately. Damaged cords increase the risk of electric shock.

**WARNING**

To reduce the risk of electrocution, keep all connections dry and off the ground. A Ground Fault Circuit Interrupter (GFCI) should be provided on the circuit(s) or outlet(s) to be used for this machine. Receptacles are available having built-in GFCI protections and may be used for this measure of safety. When using an extension cord, GFCI should be installed closest to the power source, followed by the extension cord and lastly, the machine.

**WARNING**

The water pump requires a GFCI. To reduce risk of electrical shock when operating the machine with the pump plugged into the 3-pole receptacle on the motor, connect the machine to a GFCI outlet. See the pump manual and informational tags enclosed separately for all pump information.

**WARNING**

To avoid the possibility of the appliance or plug receptacle getting wet, position the machine to one side of a wall mounted receptacle. This will prevent water from dripping into the receptacle or plug. A "drip loop," shown in the picture below, should be arranged by the user to properly position the power cord relative to the power source. Use the drip loop as a way to prevent GFCI and plug from getting wet.

The "drip loop" is that part of the cord below the level of the receptacle (or the connector, if an extension cord is used). This method of positioning the cord prevents the travel of water along the power cord and coming in contact with the receptacle.

If the plug or receptacle gets wet, **DO NOT** unplug the cord. Disconnect the fuse or circuit breaker that supplies power to the tool. Then unplug and examine for presence of water in the receptacle.

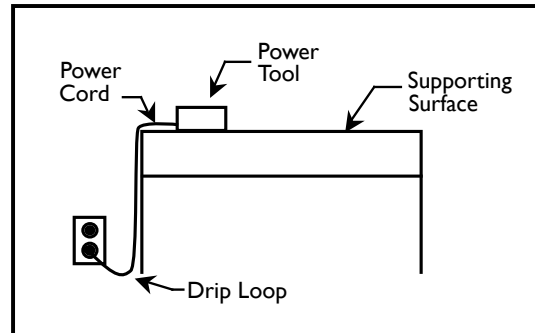

Drip Loop Information

**WARNING**

Use only extension cords that are intended for outdoor use. These extension cords are identified by a marking "Acceptable for use with outdoor appliances; store indoors while not in use." Use only extension cords having an electrical rating not less than the rating of the product. **DO NOT** use damaged extension cords. Examine extension cords before using and replace if damaged. **DO NOT** abuse extension cords and **DO NOT** yank on any cord to disconnect. Keep cords away from heat and sharp edges. Always disconnect the extension cord from the receptacle before disconnecting the product from the extension cord.

ALWAYS make certain that the power source required for the electric motor is correct and always use the correct NEMA configuration plug. Motors can burn out when the line voltage falls 10% below the voltage rating of the motor. Failure to use proper voltage will cause the motor to overheat. Make certain that the correct size grounded (3-wires) extension cord is used.

**WARNING**

Use of undersized extension cords result in low voltage to the motor that can result in motor burnout and premature failure. MK Diamond warns that equipment returned to us showing signs of being run in a low voltage condition, through the use of undersized extension cords, will be repaired or replaced totally at the customer's expense. There will be no warranty claim.

To choose the proper extension cord,

- Locate the length of extension cord needed in the table below.
- Once the proper length is found obtain the correct AWG size required for that length of extension cord.

MOTOR SPECS			EXTENSION CORD LENGTH		
Motor	Voltage	Amps	25'	50'	100'
162078	120V 1Ph	18	12 ga	10 ga	6 ga

LOCK OUT METHOD

In order to help prevent accidental starting and to help make your work area "kidproof," this machine is provided with a means to deactivate the functioning of the motor switch. The switch is equipped with a lockout tab that can be used with a lock to prevent movement of the switch. With the switch unable to move the motor cannot be turned on. Removing the lock reactivates the switch.

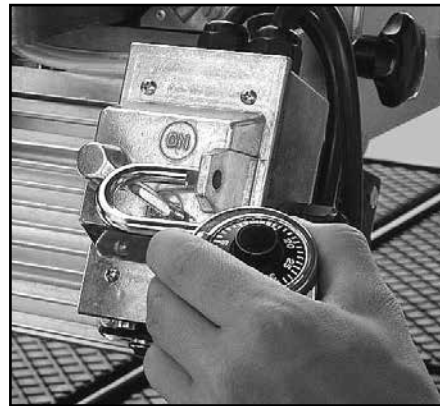
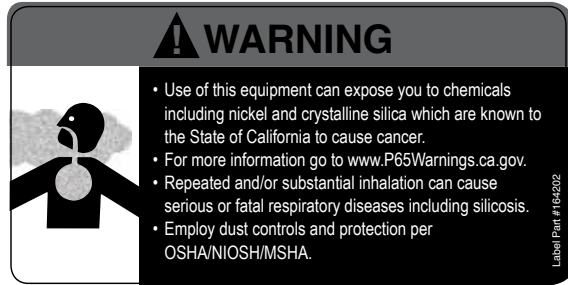

Fig. 3 Lock Out

SAFETY LABEL LOCATIONS

Safety labels are located according to the table below and the exploded views at the end of this manual. The labels contain important safety information. Please read the information contained on each safety label. These labels are considered a permanent part of your saw. If a label comes off or becomes hard to read, contact MK Diamond or your dealer for a replacement.



Part # 164202
A

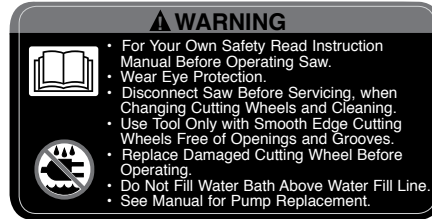

Part # 155806
B

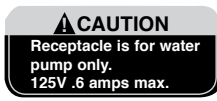

Part # 154822
C



Part # 155678
D



Part # 155038
E

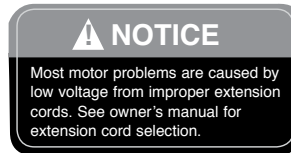

Part # 155672
F



Part # 170480
G

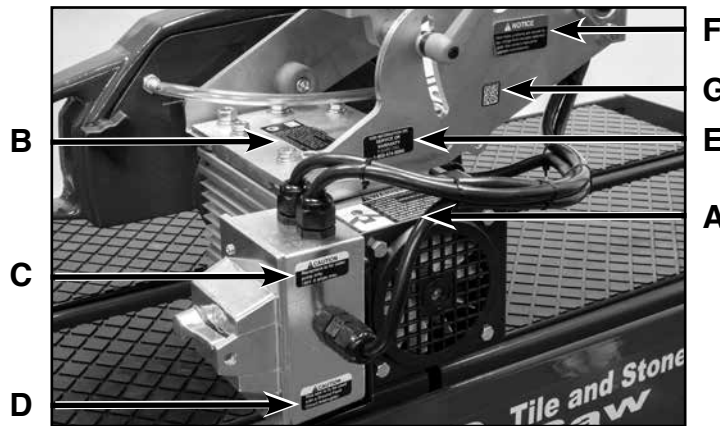

Decal/Label	Location	Description
A	Motor - Back	Warning - Silica Warning Prop 65
B	Motor - Back	Warning - Read and Follow Operating Instructions
C	Switch Box	Caution - Receptacle for Water Pump
D	Switch Box	Caution - Use with GFCI only
E	Cutting Head Arm	Service/ Warranty
F	Cutting Head Arm	Notice - Voltage/extension cords
G	Cutting Head Arm	QR Codes for Manuals

PRODUCT SPECIFICATIONS

The MK-212 is a versatile Tile and Stone Saw. Operated and used according to this manual, the MK-212 will provide years of dependable service.

GENERAL DESCRIPTION

The MK-212 Saw is engineered as a stand mounted wet tile and stone saw. The saw includes a powerful 120v direct drive AC motor.

MOTOR SPECIFICATIONS

Motor specifications for the MK-212 are listed in the table below.

	MK-212-4	MK-212-4-SPCL	MK-212-6
Horse Power	2 hp	2 hp	2 hp
Voltage	120v	120v	120v
Overall Amperage	14.4 a	14.4 a	14.4 a / 6.7 a
Frequency	60	60	60
RPM	3400	3400	3400
Weight	226 lbs	226 lbs	270 lbs
Part#	159414	159414-SPCL	167882

THERMAL OVERLOAD PROTECTION

The motor is protected by a thermal overload equipped with a manual reset.

BLADE CAPACITY

The MK-212-4 (Part# 159414) uses a ten (10) inch (254 mm) diameter wet cutting continuous rim MK Diamond blade.

The MK-212-6 (Part# 167882) uses a twelve (12) inch (305mm) diameter wet cutting continuous rim MK Diamond Blade.

The MK-212-4-SPCL (Part # 159414-SPCL) uses a twelve (12) inch (305mm) diameter wet cutting continuous rim MK Diamond Blade.

TILE TYPES

The MK-212 can cut a variety of tile types including stone, masonry, and lapidary products.

NOTE: The MK-212 is not designed to cut plastic or metals.

TILE SAW SPECIFIC WARNINGS** WARNING**

Wear eye protection.

Use splash guard for every operation for which it can be used.

Disconnect saw before servicing, when changing cutting blades, and cleaning.

Replace damaged cutting blade before operating.

UNPACKING









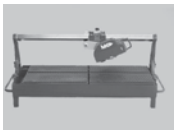

Your MK-212 has been shipped from the factory thoroughly inspected. Only minimal assembly is required.



CAUTION Use proper lifting techniques when lifting the MK-212.

CONTENTS

In your container, you will find one (1) MK-212 Saw, (4) or (6) MK-212 support legs, (1) blade wrench, (1) 2-piece protractor (1) drain plug, (1) rip guide, (1) 5/16" allen wrench, (1) 5mm allen wrench, (1) owners manual, (1) pump manual and (1) warranty card.

					
MK-212 Saw	MK-212 Support Legs	Blade Wrench	2-Piece Protractor	Drain Plug	Rip Guide
					
5/16" Allen Wrench	5mm Allen Wrench	Owner's Manual	Pump Manual	Warranty Card	

TRANSPORT

1. The MK-212 weighs approximately two hundred and twenty-six (226 to 270) pounds and for that reason should not be transported without a minimum of two persons present.
2. Never transport the MK-212 with water in the Water Pan.
3. Move Cutting Head to center and lock down when being carried by person.

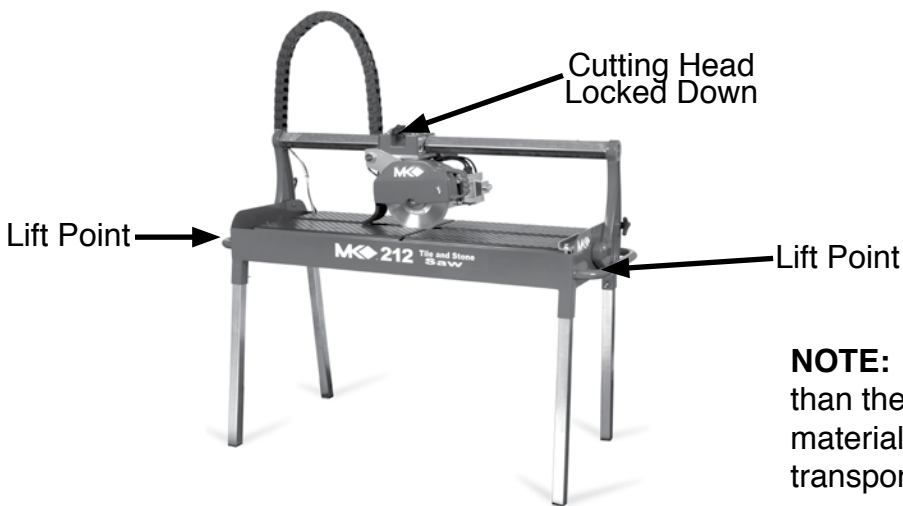

NOTE: The Cutting Head end will be heavier than the opposite end. Add block or packing material under Cutting Head (as shipped) for transporting via vehicle.

ASSEMBLY

Follow the assembly instructions to prepare your MK-212 for operation.

SUPPORT LEG INSTALLATION



(A)
Loosen the Cutting Head Locking Knob.

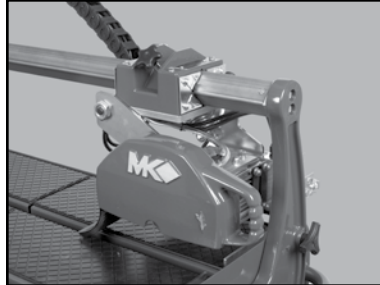

(B)
Move the Cutting Head to one end of the saw. Tighten the Cutting Head Locking Knob.



(C)
Obtain the first Leg.



(D)
Lift the end opposite of the cutting head; align the Leg with the Retaining Slot on the saw and install the Leg.

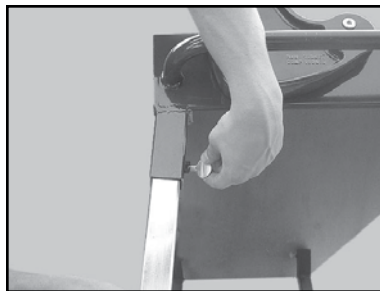

(E)
Tighten the Leg Retaining Wingnut.

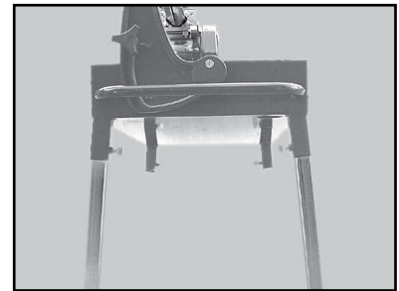

(F)
Repeat Steps C through E for the second Leg.

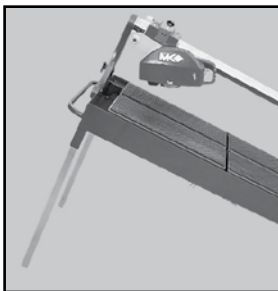

(G)
Loosen the Cutting Head Locking Knob. Move the Cutting Head to the end with the two installed Legs.



(H)
Tighten the Cutting Head Locking Knob.



(I)
Install the remaining two Legs on the opposite side of the saw using Steps C through E.

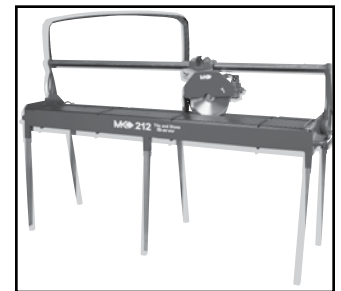

(J)
Install center legs for the MK-212-6.

DIAMOND BLADE INSTALLATION

NOTE: When installing the Retaining Nut, do not “cross-thread” and DO NOT over tighten the nut.

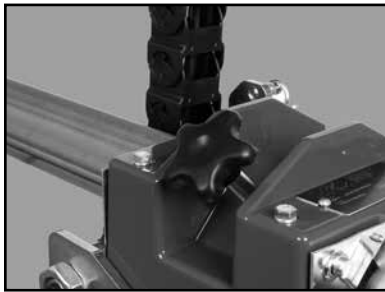

(A)
Loosen the Cutting Head Locking Knob.

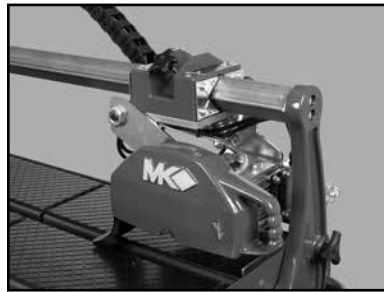

(B)
Move the Cutting Head to one end of the saw. Tighten the Cutting Head Locking Knob.

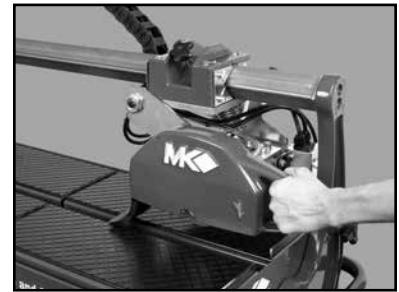

(C)
Place left hand on Cutting Head handle.



(D)
Loosen the Cutting Head Height Lock.



(E)
Raise Cutting Head. Retighten Cutting Head Height Lock.

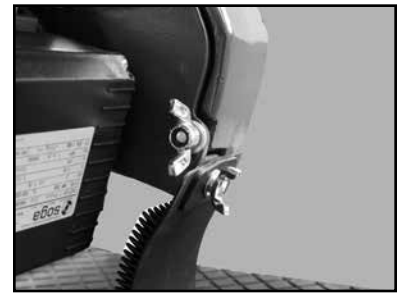

(F)
Loosen the Blade Guard Pivot Point Retaining Wingnut.



(G)
Loosen the Blade Guard Retaining Knob.

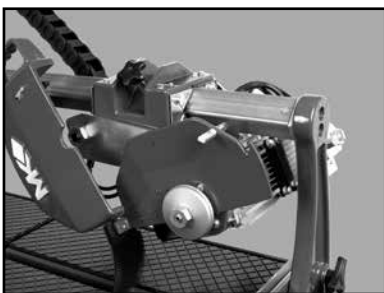

(H)
Open the Blade Guard.

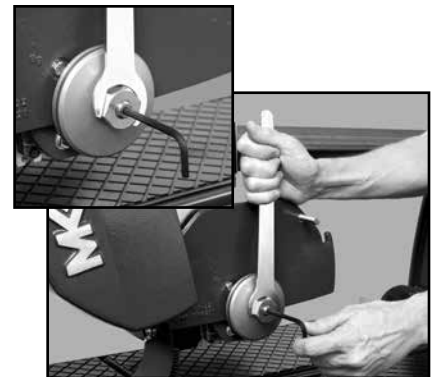

(I)
Turning clockwise, loosen the Blade Retaining Nut and remove from Blade Shaft. Use the 5mm Allen Wrench if necessary.

CAUTION

Diamond Blades improperly used are dangerous. Comply with American National Standards Institute Safety Code, B7.1 and, Occupational Safety and Health Act covering Speed, Safety Guards, Flanges, Mounting Procedures, General Operating Rules, Handling, Storage and General Machine Conditions.

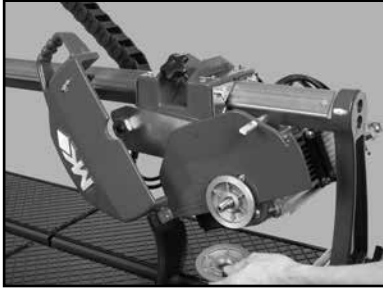

(J)
Remove the Outer Flange



(K)
Install Diamond Blade onto Blade Shaft



(L)
Verify the Directional Arrow of the Blade matches the Directional Arrow of the Blade Guard

NOTE: The Diamond Blade will have to be installed onto the MK-212 with the Directional Arrow toward the motor side of the Cutting Head for the blade to be seated correctly.

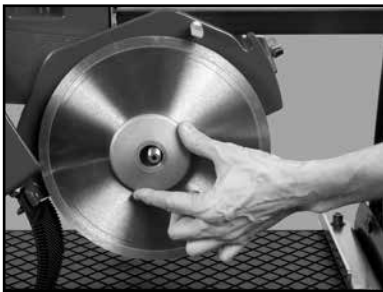

(M)
Install the Outer Flange

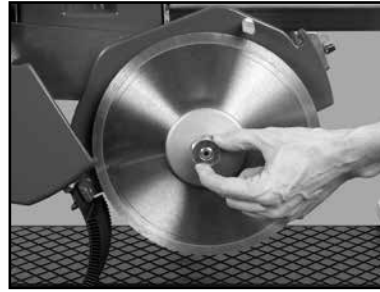

(N)
Install the Blade Retaining Nut



(O)
Verify the Blade Retaining Nut is seated in the Outer Flange

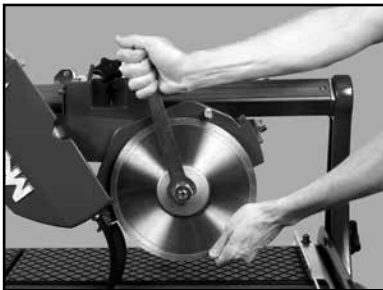

(P)
Tighten the Blade Retaining Nut

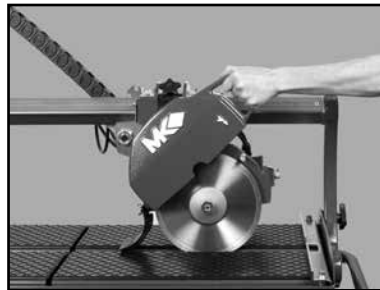

(Q)
Close the Blade Guard



(R)
Tighten the Blade Guard Pivot Point Retaining Wingnut

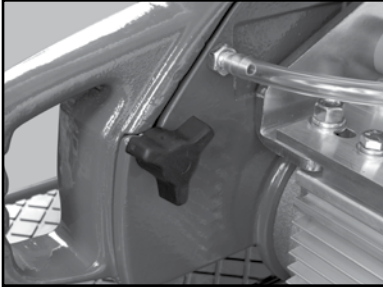

(S)
Tighten the Blade Guard Retaining Knob.

PRE-START INSPECTION

Prior to beginning work, a pre-start inspection of the saw should be performed.

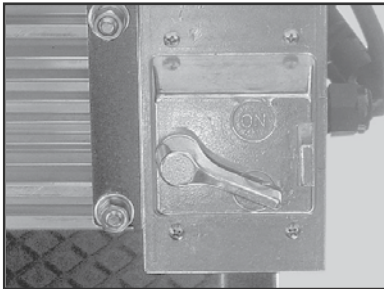

(A)
Ensure the ON/OFF Switch is in the OFF position.

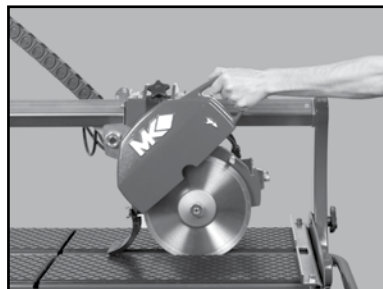

(B)
Inspect the Diamond Blade for damage – verify the blade is correct for the material being cut.

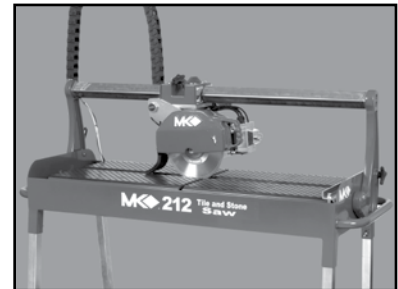

(C)
Inspect the MK-212 for damage – ensure the cord is free of cracks or cuts.

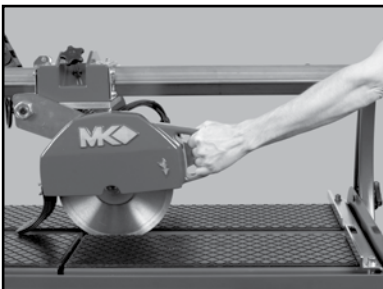

(D)
Verify the Movable Cutting Head moves freely.

WATER PUMP SETUP FOR OPERATION

The Water Pump can be setup for operation in two ways, External Water Source or Re-circulation.

NOTE: If using a dry blade for operation, DO NOT connect the water pump.

EXTERNAL WATER SOURCE

This is the preferred method of cooling.

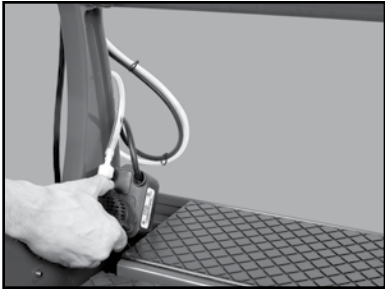

(A)
Remove water pump from water pan.

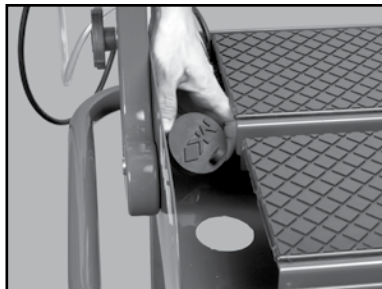

(B)
Remove the Drain Plug.



(C)
Place the Water Pump in an external container.

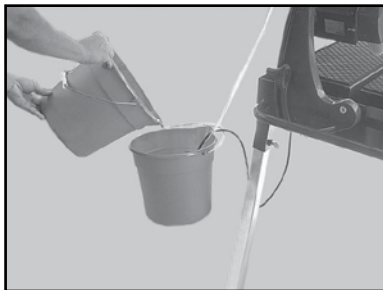

(D)
Fill the external container until water completely covers the Water Pump suction.



(E)
Place an external catch basin below the Water Basin drain hole.

RE-CIRCULATION

NOTE: When using the re-circulation method, the water should be changed often for longer pump life.

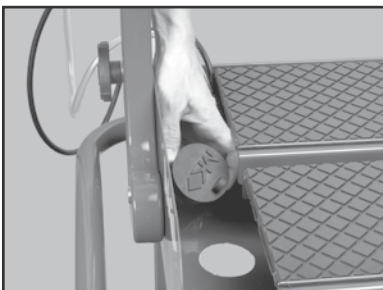

(A)
Install drain plug in drain hole in bottom of water pan.



(B)
Fill the Water Basin until water completely covers the Water Pump suction.

MK-212 ELECTRICAL CORD SETUP**CAUTION**

1. Before connecting the MK-212 to a power supply, be sure the voltage, cycle and phase meet the requirements of the table below.

VOLTAGE:	120v
CYCLE:	60hz
PHASE:	1-phase Single Phase

2. If using an extension cord, make sure the length and wire gauge correspond to the requirements listed in the table on page 12. An extension cord that is too small in wire gauge (diameter), or too long in length, will cause the motor to overheat and could cause premature failure.
3. Use an approved Ground Fault Circuit Interrupter (GFCI)
4. Do not cover the motor vents as this could lead to motor overheating.

NOTE: In order to avoid breaker tripping, a 20 amp circuit breaker should be used.

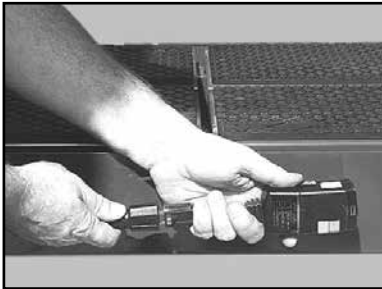

(A)

Plug MK-212 into the GFCI (A GFCI should always be used when operating the MK-212).



(B)

Plug the GFCI into the Power source.

BLADE HEIGHT ADJUSTMENT

(A)

Use Cutting Head Height Lock to adjust blade height.



(B)

The blade should not routinely be set in the full down position when cutting, only the diamond segment of the blade is below the table surface.

90° STRAIGHT EDGE CUTTING**CAUTION**

DO NOT FORCE THE TOOL. It will do the job better and safer at the rate for which it was designed.



(A)

Position the adjustable Rip Guide to desired cut length.

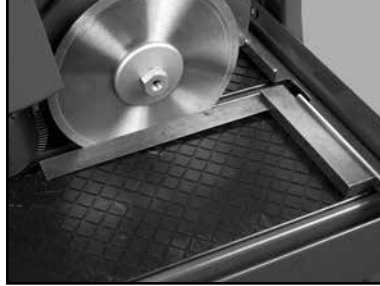

(B)

A square should be used to check alignment of the Back Stop to the Blade.



(C)

Place the tile against the Back Stop and Rip Guide. Verify the tile is seated against the Back Stop and Rip Guide.

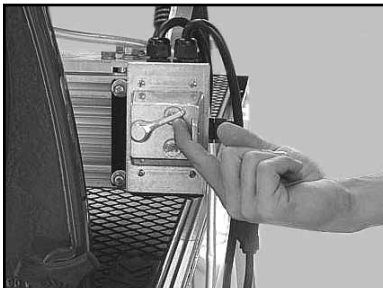

(D)

Turn the motor ON.



(E)

Verify proper cooling flow on both sides of the blade.



(F)

Perform the cut. Turn the motor OFF when work is complete.

ANGLE CUTTING

NOTE: To cut at an angle, the MK-212 has been designed with a pivoting cutting head.



CAUTION

DO NOT FORCE THE TOOL. It will do the job better and safer at the rate for which it was designed.



(A)

Loosen the two Beam Post Cutting Head Pivot Knobs located on each end of the saw.



(B)

Pivot the Cutting Head and retighten the two Pivot Knobs.



(C)

Position the adjustable Rip Guide to desired cut length. Use a Square to check alignment of the Back Stop to the Blade.



(D)

Place the tile against the Back Stop and Rip Guide. Verify the tile is seated against the Back Stop and Rip Guide.

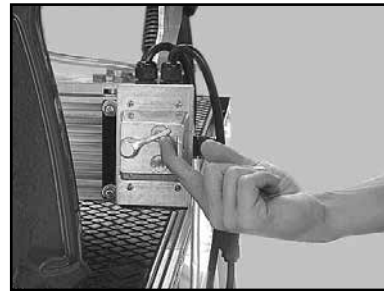

(E)

Turn the motor ON.

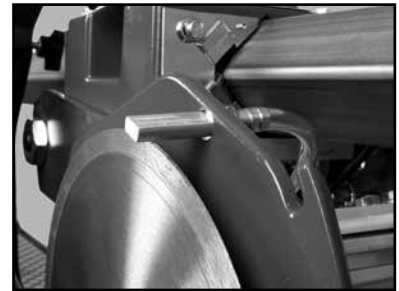

(F)

Verify proper cooling flow on both sides of the blade.



(G)

Perform the cut.

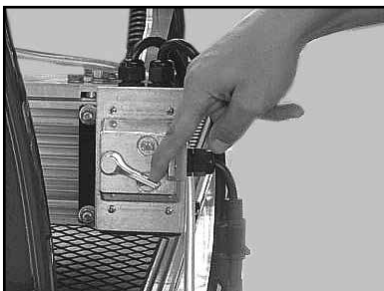

(H)

Turn the motor OFF when work is complete.

OFF-ANGLE CUTTING

NOTE: To cut angles other than 90°, a Protractor (MK Diamond Part No. -159572) should be used.

**CAUTION**

DO NOT FORCE THE TOOL. It will do the job better and safer at the rate for which it was designed.

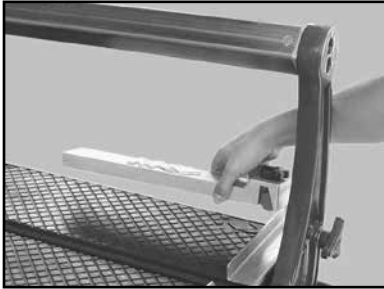

(A)
Remove the adjustable Rip Guide.



(B)
Place the Protractor on the side of the cutting table. Adjust the Protractor to fit the tile being cut and tighten the Retaining Knobs to lock the Protractor.



(C)
Set the desired Cutting Angle and tighten the Retaining Knob.

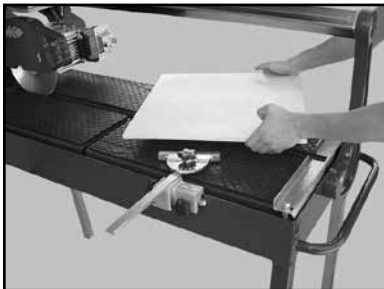

(D)
Position the tile against the Protractor and the Stop.



(E)
Verify the tile is seated against the Stop and Protractor and that the desired angle is correct.

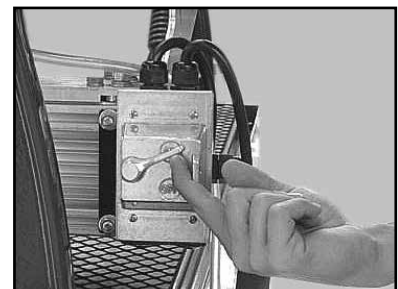

(F)
Turn the motor ON.



(G)
Verify proper cooling flow on both sides of the blade.

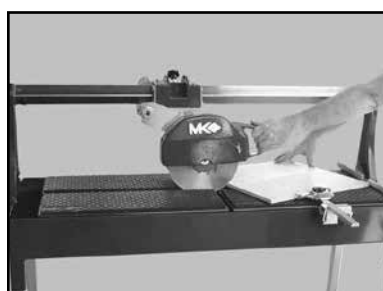

(H)
Perform the cut.



(I)
Turn the motor OFF when work is complete.

CLEANUP

- NOTES:** 1. If an external water source was used, steps A through C may be skipped.
 2. Dispose of wastewater in accordance with applicable Federal, State and Local laws.



(A)
Clean the Water Pump suction of all debris.



(B)
Place the Water Pump in an external container.



(C)
Run the saw until clear water is seen at the blade cooling ports (Approx. 1 minute).



CAUTION

Ensure the saw is disconnected before completing the remainder of the cleanup process.

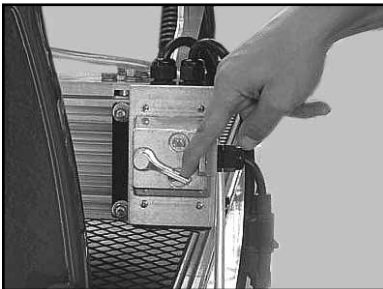

(D)
Ensure the ON/OFF Switch is in the OFF position.



(E)
Unplug the GFCI from the Power source.

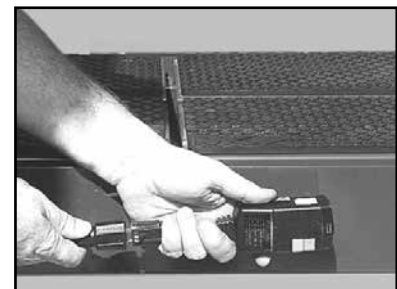

(F)
Unplug MK-212 from the GFCI.



(G)
Clean the MK-212 with soap and clean water.



(H)
Drain the Water Pan and dispose of the water in accordance with all State, Local and Federal laws.

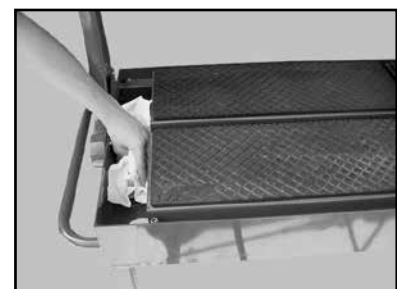

(I)
Clean the Water Pan.



CAUTION

Ensure water is not forced into the motor casing when cleaning.

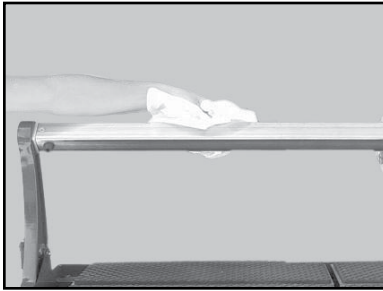

(J)
Clean the Guide Rail.

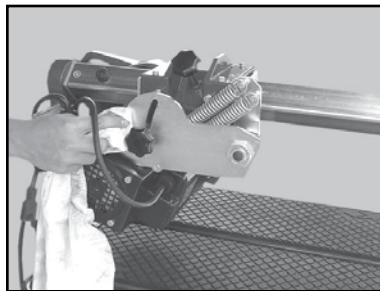

(K)
Clean the Movable Cutting Head.



(L)
Clean the remainder of the
MK-212.

MAINTENANCE FOLLOWING USE

To extend the life of the MK-212, the following procedure should be performed after each use.

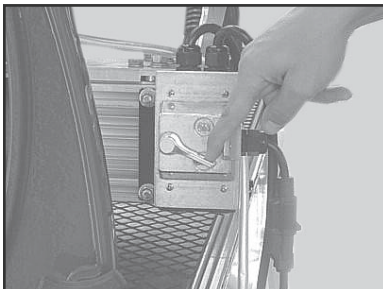

(A)
Ensure the ON/OFF Switch is in
the OFF position.

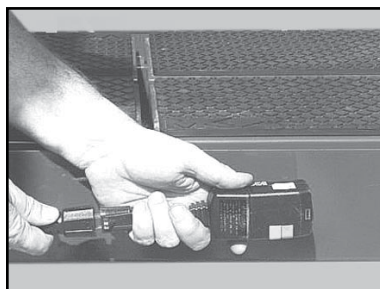

(B)
Unplug MK-212.



(C)
Lubricate the Guide Rail.

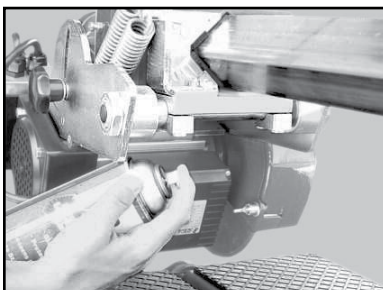

(D)
Lubricate the Cutting Head.

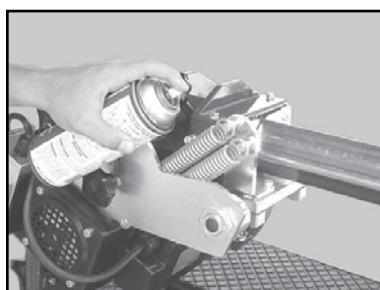

(E)
Lubricate the Cutting Head
springs.

MONTHLY MAINTENANCE

The following maintenance should be performed monthly.



(A)
Remove the Diamond Blade and
Inner Flange.



(B)
Clean the Inner Flange.



(C)
Lubricate the Inner Flange Gasket.

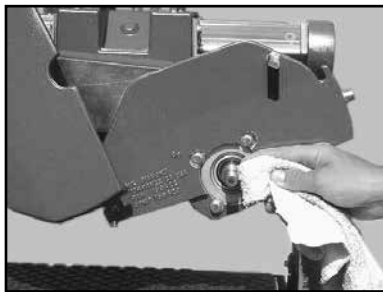

(D)
Clean the Blade Shaft.

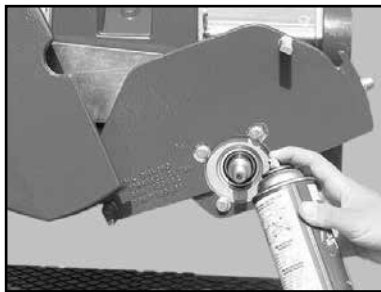

(E)
Lubricate the Blade Shaft

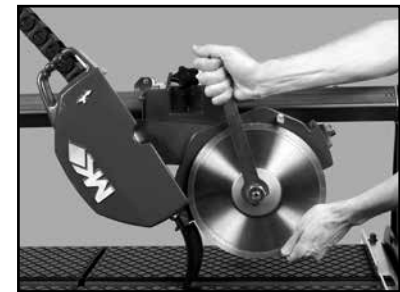

(F)
Reinstall the Inner Flange and
Blade.

DIAMOND BLADE CHANGE-OUT

NOTE: When installing the Retaining Nut do not "cross-thread" and DO NOT over tighten the screw.



(A)
Loosen the Cutting Head Locking Knob.

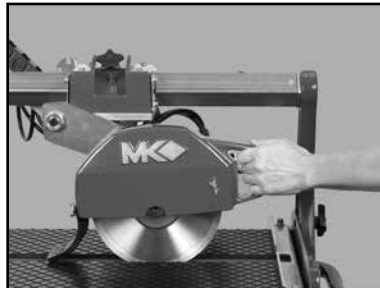

(B)
Move the Cutting Head to one end of the saw. Tighten the Cutting Head Locking Knob.

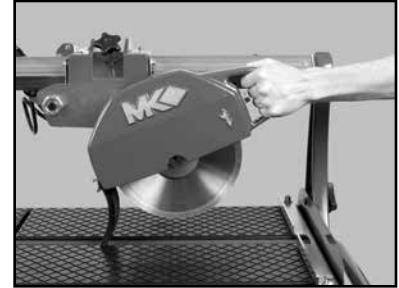

(C)
Loosen the Cutting Head Height Lock. Raise the cutting height. Retighten Cutting Head Height Lock.



(D)
Loosen the Blade Guard Pivot Point Retaining Wingnut.



(E)
Loosen the Blade Guard Retaining Knob.

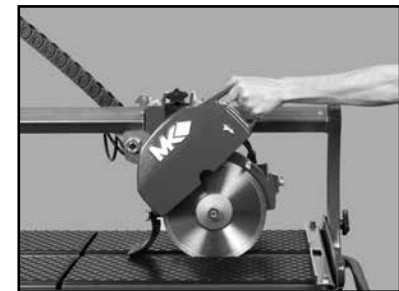

(F)
Open the Blade Guard.

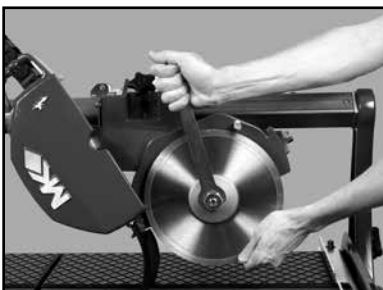

(G)
Loosen and remove the Blade Retaining Nut.

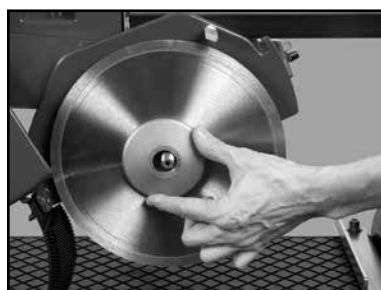

(H)
Remove the Outer Flange.



(I)
Remove the old Diamond Blade.

NOTE: The Diamond Blade will have to be installed onto the MK-212 with the Directional Arrow toward the motor side of the Cutting Head for the blade to be seated correctly.

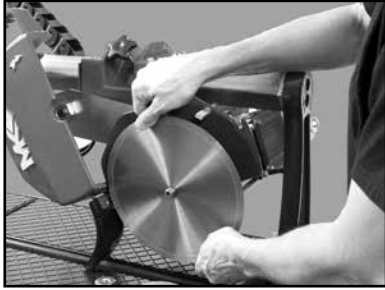

(J)
Install the new Diamond Blade onto the Blade Shaft.



(K)
Verify the Directional Arrow of the Blade matches the Directional Arrow of the Blade Guard.



(L)
Install the Outer Flange.



(M)
Install the Blade Retaining Nut.



(N)
Verify the Blade Retaining Nut is seated in the Outer Flange.

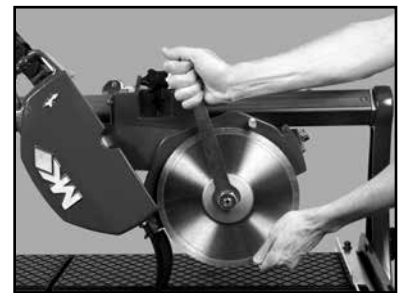

(O)
Tighten the Blade Retaining Nut.

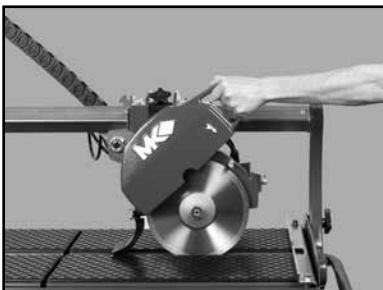

(P)
Close the Blade Guard.



(Q)
Tighten the Blade Guard Retaining Knob.

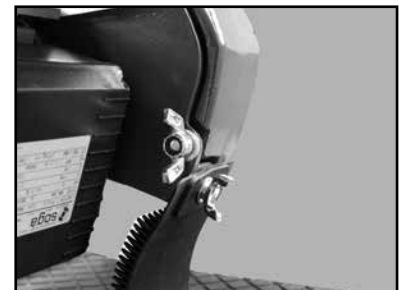

(R)
Tighten the Blade Guard Pivot Point Retaining Wingnut.

TABLE REMOVAL

NOTE: The rubber topped Cutting Table may be removed to clean the Water Pan or to be replaced.

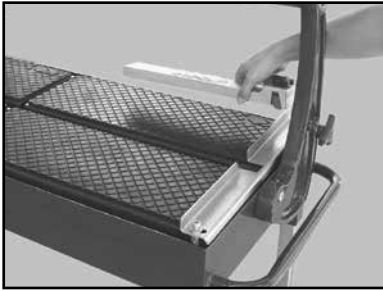

(A)
Remove the Adjustable Rip Guide.



(B)
Remove the Back Stop.

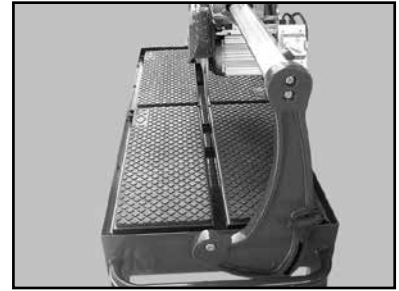

(C)
Locate the table Retaining Screws on both sides of the cutting surface.



(D)
Remove all Retaining Screws using the Allen Wrench provided.

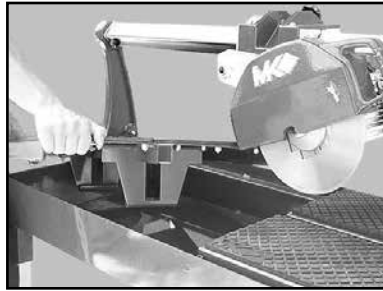

(E)
Remove table Cutting Surface pieces.



(F)
Clean the Water Pan.



(G)
Reinstall all components removed in steps A through E.

CUTTING HEAD ALIGNMENT

NOTE: The alignment of the Cutting Head should be checked periodically to ensure the accuracy of the cut.

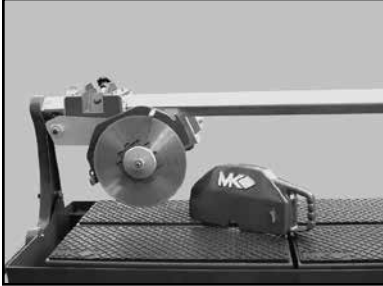

(A)
Remove the Blade Guard.



(B)
Using a combination square, check the Blade for vertical alignment.

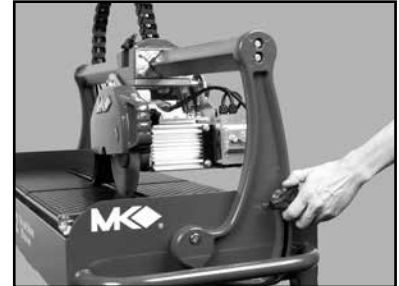

(C)
Loosen the two Beam Post Cutting Head Pivot Knobs located on each end of the saw.



(D)
Pivot the Beam and retighten the two Pivot Knobs.



(E)
Using a combination square, check the Blade for 45° alignment.



(F)
Loosen the four Guide Rail Adjusting Screws using a 1/2-inch socket.



(G)
Adjust the Guide Rail until it is aligned both vertically and horizontally.

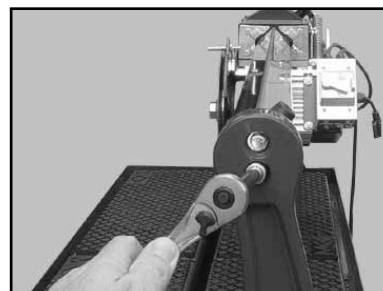

(H)
Tighten the four Guide Rail Adjusting Screws using a 1/2-inch socket.

TROUBLESHOOTING

Blade will not cut properly



(A)

Check for Smoothness or "Glazing" (Dress blade if needed).



(B)

Check for proper rotation.



(C)

Ensure the Blade Core is not bent and Arbor is not out of round.



(D)

Verify the blade is correct for the material being used.

COOLING FLOW

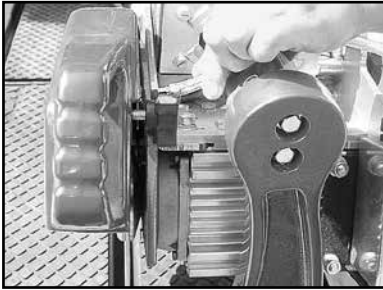

(A)
Remove the Cooling Transfer Tube from the Blade Guard inlet.

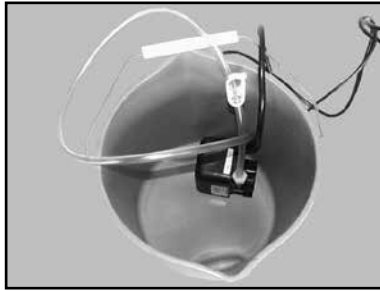

(B)
Place Pump into a bucket of water and check flow.

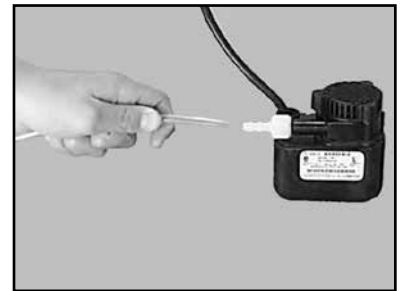

(C)
Remove the Cooling Transfer Tube and check for flow.



(D)
Remove the Pump Discharge Fitting and check for flow.



(E)
Remove the Pump Intake Screen and check for debris – clean the screen if necessary.



(F)
Rod (clean out) the Cooling Manifold and then recheck flow.

NOTE: “Rodding” cooling channels is performed by inserting a small wire rod through the cooling inlet on top of the Blade Guard and directing the rod out through each of the cooling flow tubes located on the underside of the Blade Guard. The cooling channels should be “rodded” until all ports are free of foreign debris.

CUTTING HEAD DOES NOT MOVE CORRECTLY

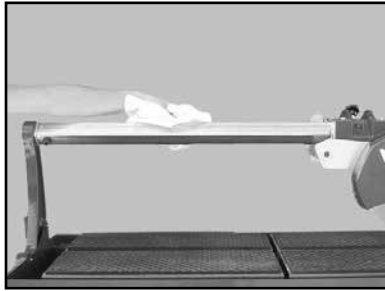

(A)
Check that Guide Rail and Cutting Head is clean and clean if dirty.

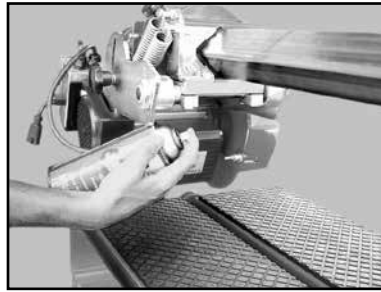

(B)
Lubricate the Guide Rail and Cutting Head.

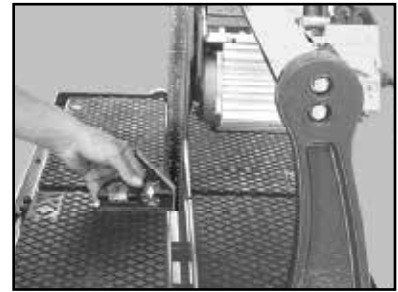

(C)
Check the Cutting Head alignment.

BLADE STOPS TURNING

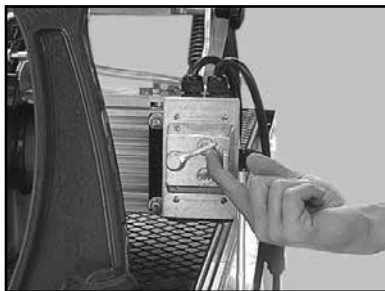

(A)
Check the ON/OFF Switch is in the ON position.

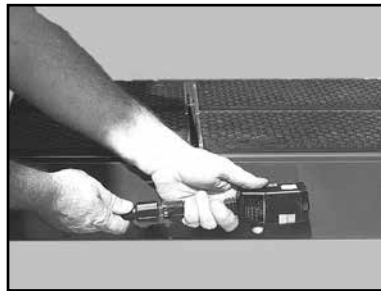

(B)
Verify all plugs are fully connected.



(C)
Check to see if the Ground Fault Circuit Interrupter (GFCI) tripped.



(D)
Verify the circuit breaker is at least 20 amps – if not, move to 20 amp circuit.



(E)
Verify circuit breaker not tripped; if it is tripped, reset it once only.



(F)
Check power source voltage is 115v – if not 115v, move to another circuit.

ITEM	NUMBER	DESCRIPTION	
1.	Various	MK-275, Marble Profile Wheel	
2.	153495 155129	MK-415, 10" or 12" Diamond Blade	
3.	137471 151296	MK-62M, 10" or 12" Diamond Blade for Marble	
4.	151403 150789	MK-62G 10" or 12" Diamond Blade for Granite	
5.	152792	Dressing Stone	
6.	167986	Side Table - 33" X 24"	
7.	165884	Side Table - 23" X 9"	
7.	166271	Foot Switch	
8.	160172	Transport Wheels	

ORDERING INFORMATION

You may order MK Diamond products through your local MK Diamond distributor or, you may order direct from MK Diamond.

When ordering direct from MK Diamond, please have the following information ready before calling:

- The Model Number of the saw
- The Serial Number of the saw
- Where the saw was purchased and when
- The Part Number for the part(s) being ordered
- The Part Description for the part(s) being ordered

NOTE: Standard orders are \$50.00 or more when ordering direct from MK Diamond. A \$6.00 charge will be added to orders having a net billing value under \$50.00. A nominal handling fee of \$5.00 may apply to some orders.

All parts may be ordered by calling toll free to – 800 421-5830 or 310 539-5221 and asking for Customer Service. For technical questions, call – 800 474-5594.

RETURN MATERIALS POLICY

To expedite the service relative to the return of a product purchased through MK Diamond, please observe the following:

NOTE: When returning all items, they must have been purchased within the previous twelve (12) months.

- Have the Model Number of the saw
- Have the Serial Number of the saw
- Have the location of where the saw was purchased
- Have the date when the saw was purchased
- Contact Customer Service for approval to return the item(s)
- Obtain a Returned Goods Number (RGA) authorizing the return
- Follow the packaging instructions in the following section
- Ensure the RGA number is on the outside of the returned package
- Ensure your item(s) are prepaid to the destination

For returned items, call toll free to – 800 421-5830 or 310 539-5221 and ask for Customer Service.

PACKAGING INSTRUCTIONS

- Remove the Cutting Head and Support Angle Assembly
- Dry the saw before shipping
- When packing, include the following: Saw, Diamond Blade, Blade Guard and Support Angle Assembly and Adjustable Cutting Guide (Other Accessories are not required)
- Package the unit in its original container or one of comparable size (do not ship the unit partially exposed)
- Ensure all parts are secured in the packaging to prevent moving

AUTHORIZED SERVICE CENTERS

For quicker repair time, you may contact MK Diamond Customer Service, toll free, at 800 421-5830 or 310 539-5221 for the Authorized Service Center closest to you or visit our web site at www.mkdiamond.com. For technical questions, call – 800 474-5594.

CONTACT

Please contact MK Diamond Products, Inc. Customer Service Department with any questions you might have regarding distributors, parts or service.

Telephone: **(800) 421-5830**

Fax: **(310) 539-5158**

E-mail: **Customer_Service@MKDiamond.com**

Customer Service Hours: **Monday through Friday, 6AM-4PM PST**

MK Diamond Products, Inc.

1315 Storm Parkway

Torrance, CA 90501

MK DIAMOND PRODUCTS, INC. LIMITED WARRANTY

MK DIAMOND PRODUCTS, INC. will guarantee every machine they build, to be free from defects in material and workmanship for (1) one year from date of purchase. The obligation of MK DIAMOND PRODUCTS, INC. under this warranty is limited to the repair or replacement of any parts which, under normal use, prove to be defective in material or workmanship. The parts involved or the unit in question should be returned to MK DIAMOND PRODUCTS, INC. or to a point designated by us, transportation prepaid.

This warranty does not obligate us to bear the cost of labor or transportation charges in connection with replacement or repair of defective parts. Likewise, it shall NOT apply to any unit which has been subjected to misuse, neglect or accident. This warranty does NOT apply to any machine which has been repaired or altered outside our factory.

This warranty does NOT obligate MK DIAMOND PRODUCTS, INC., with respect to items not of our manufacture, such as engines, motors, hydraulics, etc., which are subject to their own guarantees and warranties.

We shall in no event be liable for consequential damages or contingent liabilities arising out of failure of any equipment or parts to operate properly.

WARRANTY: For your (1) one year warranty to be effective, complete the online Product Registration as soon as possible. Visit **www.mkdiamond.com/registration/**

© **COPYRIGHT 2019, MK DIAMOND PRODUCTS, INC. ALL RIGHTS RESERVED.**

The MK Diamond logo is a registered trademark of MK Diamond Products, Inc. and may not be used, reproduced, or altered without written permission. All other trademarks are the property of their respective owners and used with permission.

MK Diamond may have patents, patent applications, trade marks, copyrights of other intellectual property right covering this product in this document.

This manual **MUST** accompany the equipment at all times. This manual is considered a permanent part of the equipment and should remain with the unit if resold.

The information and specifications included in this publication were in effect at the time of approval for printing.

NOTES

NOTES

MK-212 SERIES SAW
OWNERS MANUAL & OPERATING INSTRUCTIONS



MK Diamond Products, Inc.

MK Diamond Products, Inc.
1315 Storm Parkway
Torrance, CA 90501

Toll-Free: (800) 841-5830
Phone: (310) 539-5221
Fax: (310) 539-5158
www.mkdiamond.com