

1. Remove both front screws.

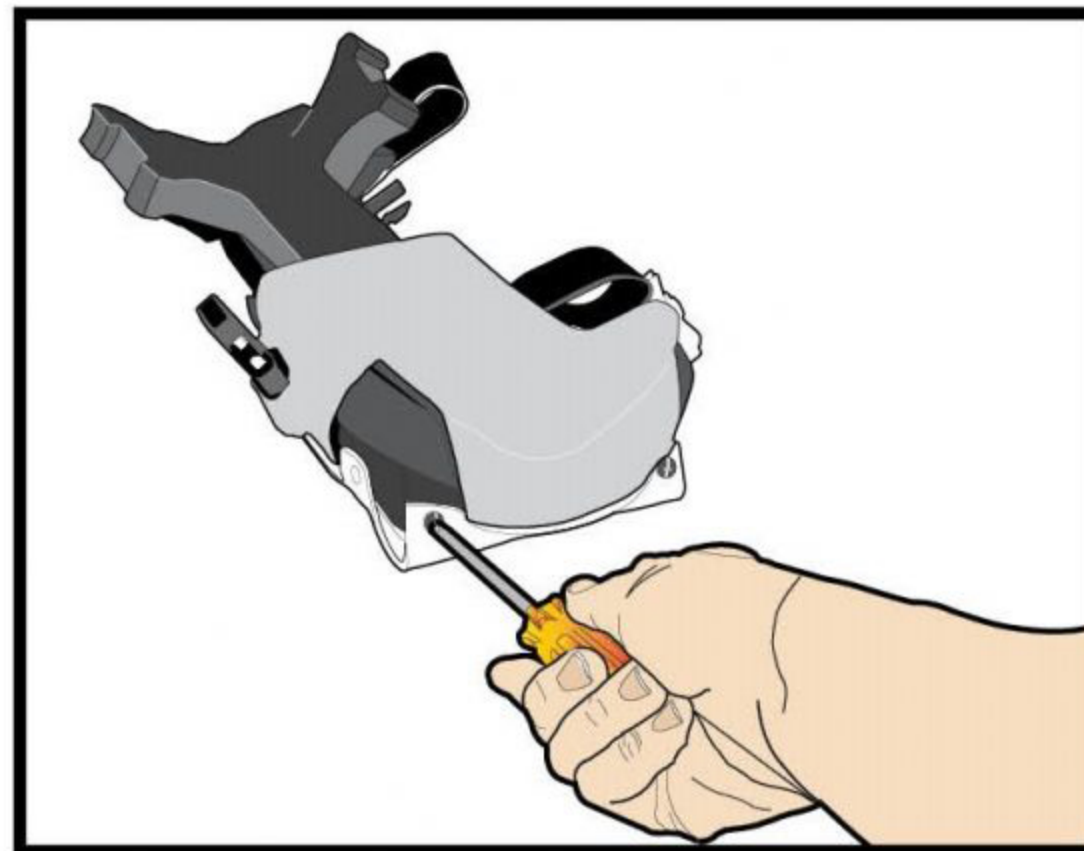

2. Remove worn No Wrinkle Liner.

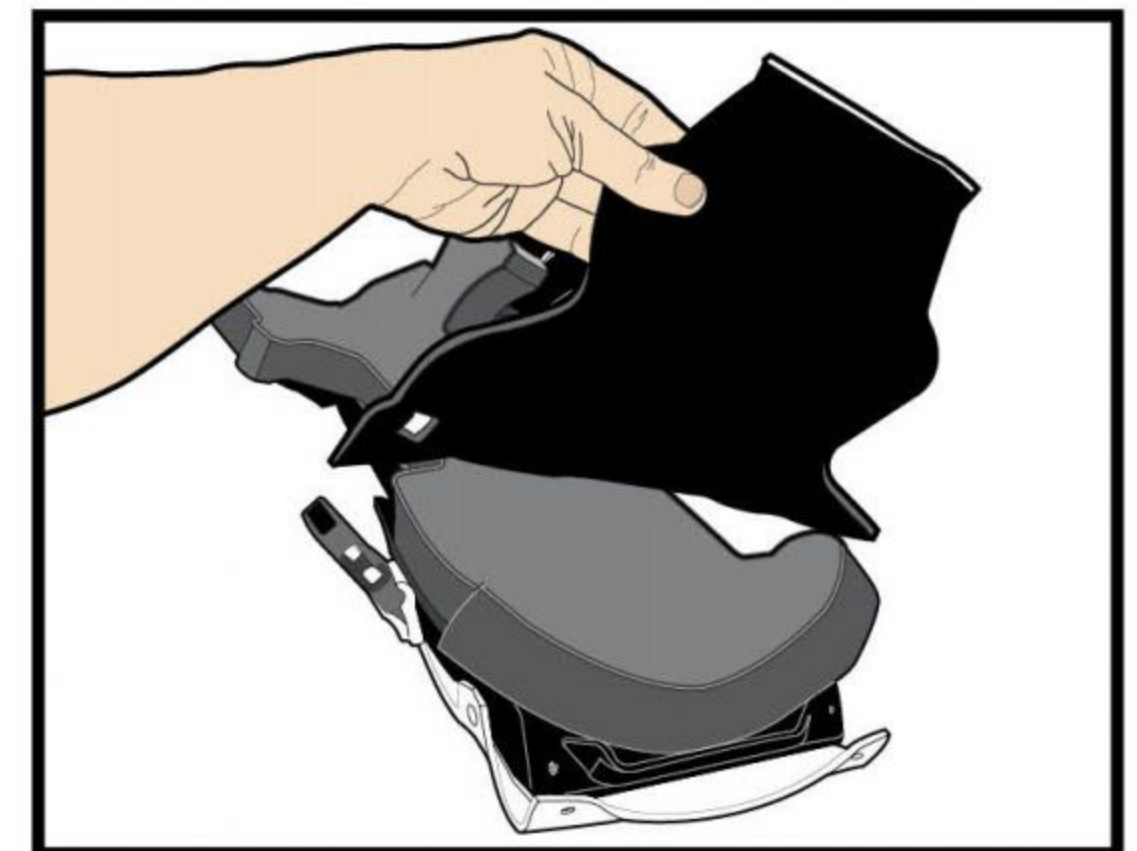

3. Place Hook 'n Loop on the Knee Seat, if needed.
(Use shaded areas in illustration below for correct placement)

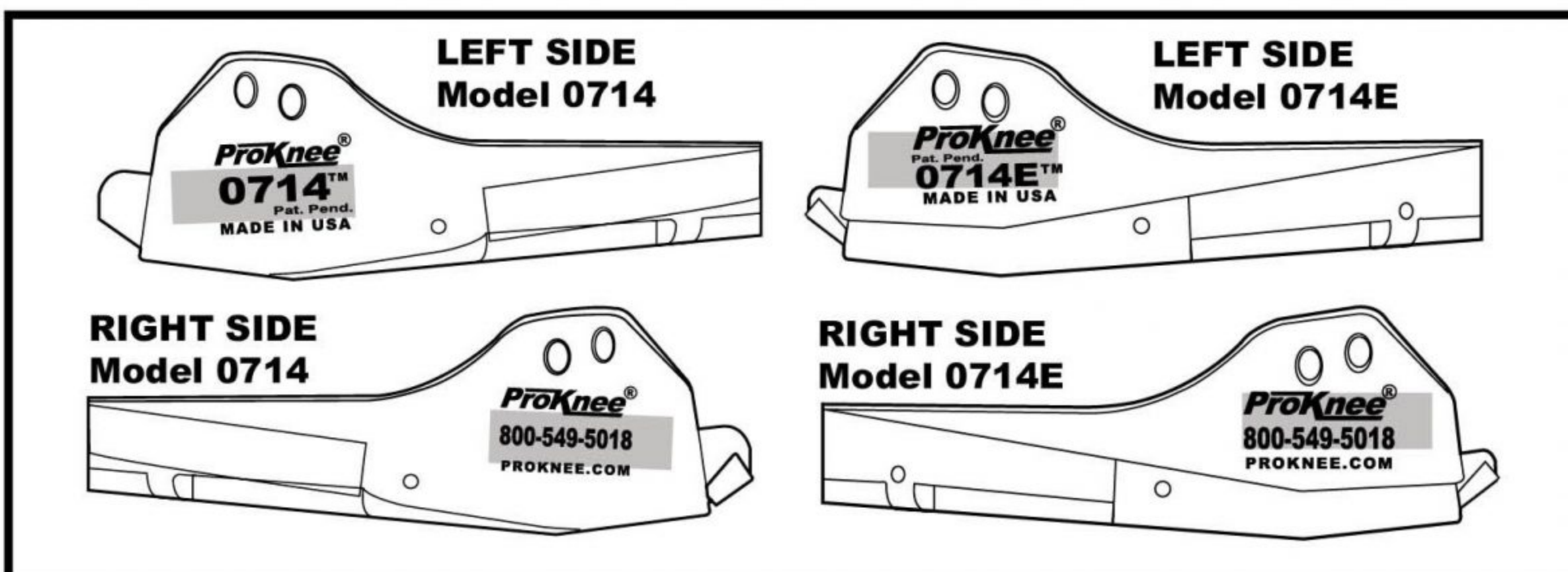

4. Align new No Wrinkle Liner using Fig 1.

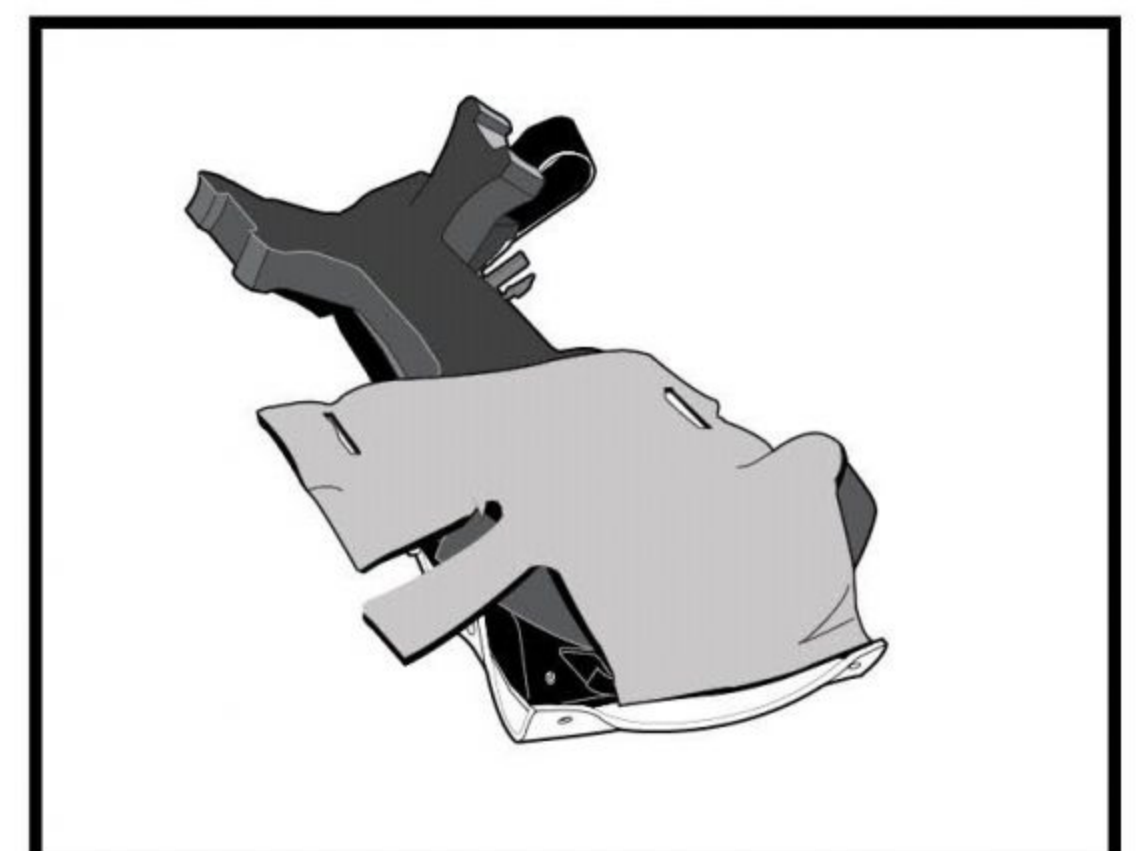

5. Thread slot (A) over female buckle and attach to Hook 'n Loop. (Fig 2)

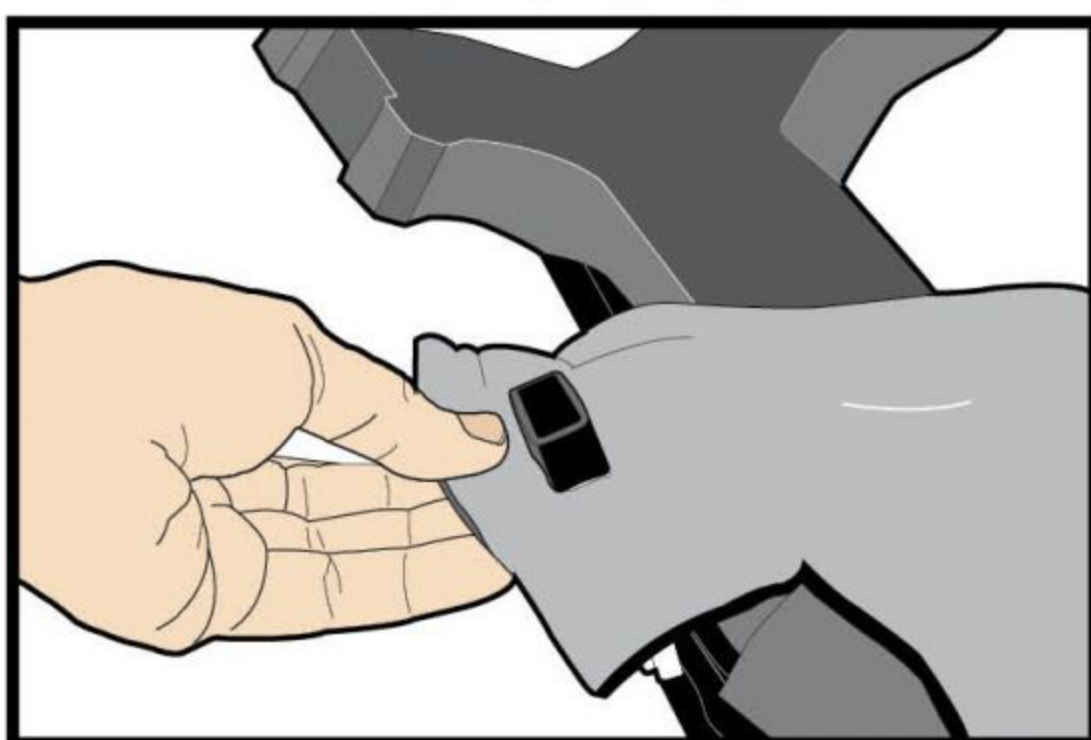

6. Thread slot (B) over male buckle/strap and attach to Hook 'n Loop. (Fig 2)

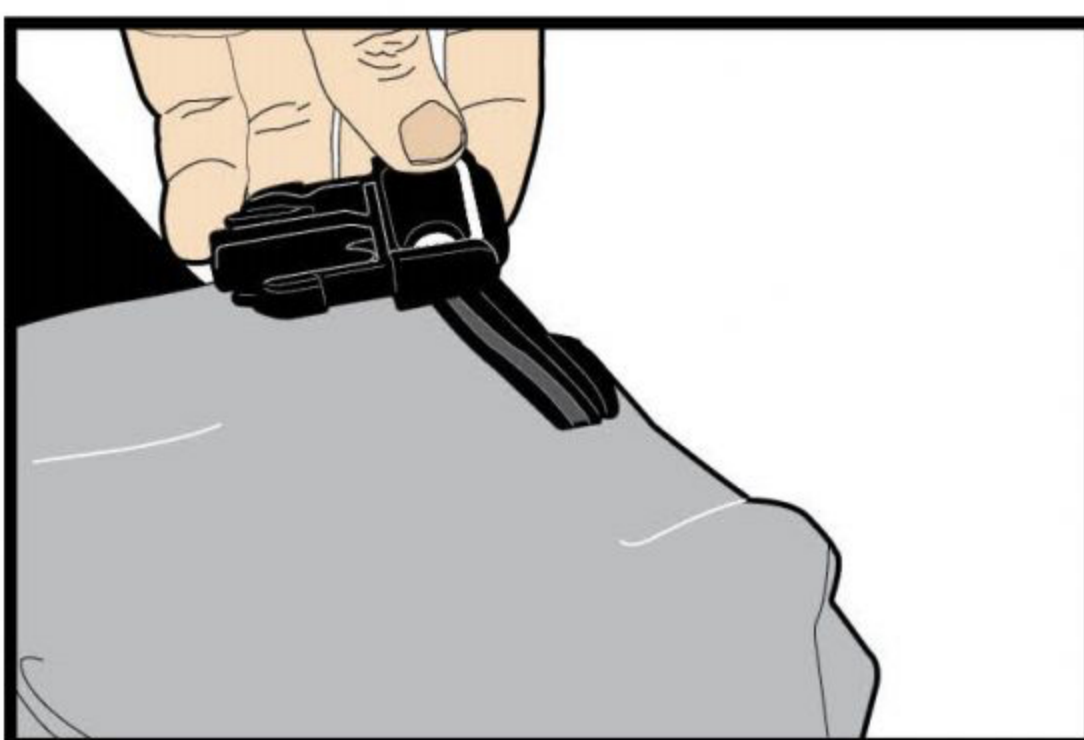

7. Tuck front end of No Wrinkle Liner (C) onto Hook 'n Loop. (Fig 2)

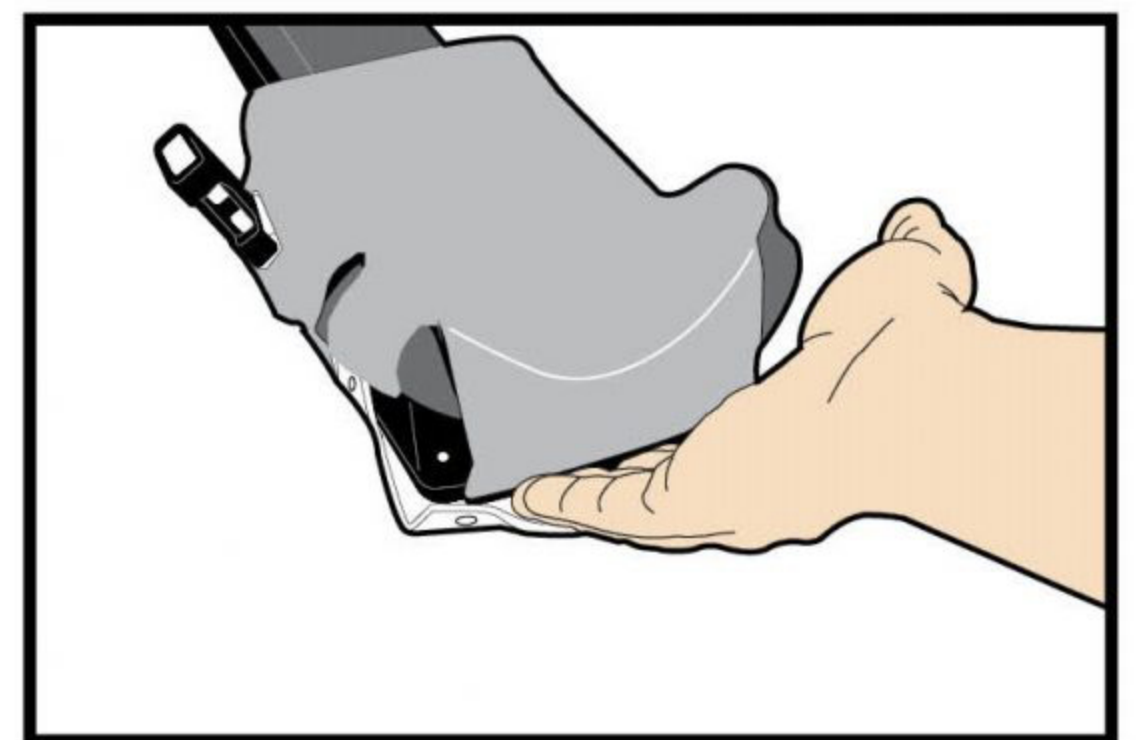

8. Replace both front screws.

