

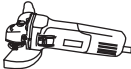

# TOPPROFILE









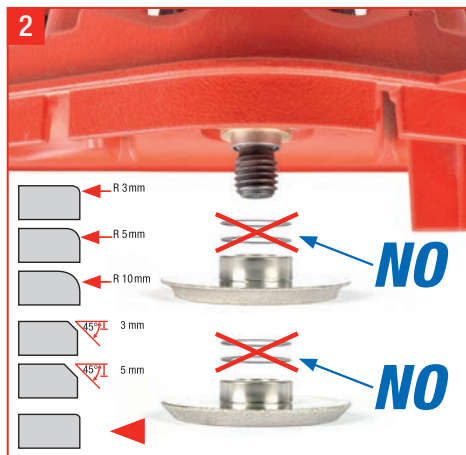
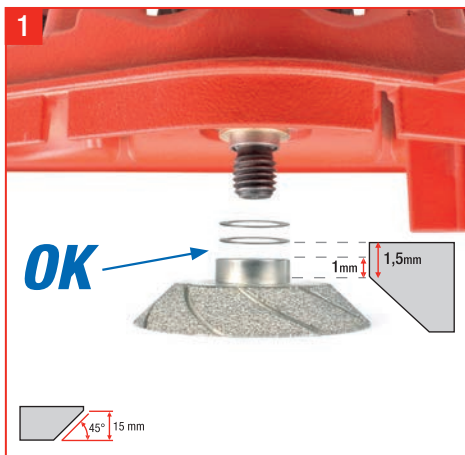







SINCE 1946



Art./Item	
TOPPROFILE	230 V~ · 800 W · 3,5 A · 50/60 Hz · 11.000 RPM
TOPPROFILE-115V	110/120 V~ · 900 W · 8,2 A · 50/60 Hz · 11.000 RPM

- IT** **ATTENZIONE!** L'utilizzo degli anelli distanziatori per le frese è indispensabile quando si effettua il jolly (figura 1), per le altre lavorazioni (figura 2) togliere tali distanziatori.
- EN** **CAUTION!** The use of spacer rings for the cutters is essential when implementing a miter cut (figure 1). Remove the spacers for other types of machining (figure 2).
- FR** **ATTENTION!** Il est indispensable d'utiliser les anneaux d'écartement pour les fraises lors de la réalisation du jolly (figure 1), mais les écarteurs doivent être enlevés pour les autres usinages (figure 2).
- DE** **ACHTUNG!** Bei der Herstellung von Jollykanten (Abbildung 1) müssen die Abstandshalterringe verwendet werden, bei anderen Bearbeitungen (Abbildung 2) sind diese zu entfernen.
- ES** **¡ATENCIÓN!** El uso de anillos distanciadores para las fresas es indispensable cuando se realiza el jolly (figura 1); para las demás operaciones (figura 2) quitar dichos distanciadores.
- RU** **ВНИМАНИЕ!** Использование разделительных колец для сверл имеет важное значение, когда выполняется джолли (рисунок 1), для других работ (рисунок 2) эти прокладки следует удалить.
- CS** **POZOR!** Použití distančních kroužků pro frézy je nezbytné v případě zabrušování hran pod úhlem JOLLY (kamenický roh) (obrázek 1), pro ostatní zpracování (obrázek 2) tyto distanční kroužky odstraňte.
- DA** **FORSIGTIG!** Anvendelsen af afstandsringe til knivene er afgørende, når der udføres en geringsskæring (figur 1). Fjern afstandsstykker til andre former for bearbejdning (figur 2).
- FI** **VAROITUS!** Jyrsimissä on käytettävä välirenkaita, kun suoritetaan jolly (kuva 1). Muissa työstöissä (kuva 2) välirenkaat on poistettava.
- HR** **POZOR!** Uporaba prstenastih odstojnika za glodalice nužna je kod izvođenja jolly reza (slika 1), dok je kod ostalih obrada (slika 2) potrebno ukloniti takve odstojnike.
- NO** **VÆR OPPMERKSOM!** Det er uunnværlig å ta avstandsringene i bruk når man utfører jolly (figur 1). Når det gjelder andre bearbeidelser, (figur 2) fjerner man avstandsringene.
- NL** **LET OP!** Het gebruik van afstandsringen voor de frezen is essentieel bij het uitvoeren van de jolly (afbeelding 1), voor andere verwerkingen (afbeelding 2) deze afstandhouders verwijderen.
- PL** **UWAGA!** Do wykonywania krawędzi skośnych należy używać pierścieni dystansowych do frezów (rysunek 1), podczas gdy do innych obróbek elementy te należy usunąć (rysunek 2).
- PT** **ATENÇÃO!** A utilização dos anéis espaçadores para as brocas é indispensável na execução de cortes em ângulo (figura 1); para os outros tipos de processamento (figura 2) remova estes espaçadores.
- RO** **ATENȚIE!** Utilizarea inelelor de distanțiere pentru freze este indispensabilă când se efectuează jolly (figura 1), pentru celelalte lucrări (figura 2), îndepărtați distanțierele.
- SV** **OBSERVERA!** När man gör avfasningar vid 45° (bild 1) måste man använda distansringar till fräsarna. Vid alla andra bearbetningar (bild 2) ska distansringarna däremot tas bort.
- SL** **POZOR!** Pri zajeralnih rezih je uporaba distančnih obročkov nujna (slika 1), prid drugih vrstah obdelave (slika 2) pa je treba distančnike odstraniti.
- SR** **PAŽNJA!** Upotreba dostojnih prstenova za rezače je potrebna kada se izvršava jolly (slika 1), za ostale radove (slika 2) uklonite te odstojnike.



<p><b>Art. FPB03TP</b></p> <ul style="list-style-type: none"> <li>• R = 3 mm (1/8")</li> <li>• PROFILE: B  ← R 3 mm</li> </ul>	
<p><b>Art. FPB05TP</b></p> <ul style="list-style-type: none"> <li>• R = 5 mm (3/16")</li> <li>• PROFILE: B  ← R 5 mm</li> </ul>	
<p><b>Art. FPB10TP</b></p> <ul style="list-style-type: none"> <li>• R = 10 mm (3/8")</li> <li>• PROFILE: B  ← R 10 mm</li> </ul>	
<p><b>Art. FPE03TP</b></p> <ul style="list-style-type: none"> <li>• 45° = 3 mm (1/8")</li> <li>• PROFILE: E  ← 45° 3 mm</li> </ul>	
<p><b>Art. FPE05TP</b></p> <ul style="list-style-type: none"> <li>• 45° = 5 mm (3/16")</li> <li>• PROFILE: E  ← 45° 5 mm</li> </ul>	
<p><b>Art. FPE15TP</b></p> <ul style="list-style-type: none"> <li>• JOLLY - 45° = 15 mm (5/8")</li> <li>• PROFILE: E  ← 45° 15 mm</li> </ul> <p><b>MEDIUM:</b> IT Per spessori superiori a 6 mm EN For thicknesses exceeding 6 mm FR Pour des épaisseurs de plus de 6 mm DE Für Stärken über 6 mm ES Para espesores mayores de 6 mm RU Для толщины свыше 6 мм CS Pro zabrašování do hloubky vyšší než 6 mm DA Til tykkelser over 6 mm FI Yli 6 mm paksulle materiaalille HR Za debljine veće od 6 mm NO For tykkelser som er større enn 6 mm NL Voor meer dan 6 mm dikte PL Do grubości większych niż 6 mm PT Para espessuras superiores a 6 mm RO Pentru grosimi mai mari de 6 mm SV För tjocklekar över 6 mm SL Za debeline, veće od 6 mm SR Za debljine veće od 6 mm</p>	
<p><b>Art. FPE15TPGF</b></p> <ul style="list-style-type: none"> <li>• JOLLY - 45° = 15 mm (5/8")</li> <li>• PROFILE: E  ← 45° 15 mm</li> </ul> <p><b>FINE:</b> IT Per spessori fino a 6 mm e piastrelle delicate EN For thicknesses up to 6 mm and delicate tiles FR Pour des épaisseurs jusqu'à 6 mm ainsi que pour des carreaux fragiles DE Für Stärken bis 6 mm und empfindliche Fliesen ES Para espesores hasta 6 mm y azulejos delicados RU Для толщины до 6 мм и хрупких плиток CS Pro zabrašování do hloubky do 6 mm a pro křehké dlaždice DA Til tykkelser op til 6 mm og sarte fliser FI Enintään 6 mm paksulle materiaalille ja särkyville laatoille HR Za debljine do 6 mm i osjetljive pločice NO For tykkelser på opp til 6 mm og delikate fliser NL Voor diktes tot 6 mm en delicate tegels PL Do grubości max 6 mm i delikatnych płytek PT Para espessuras de até 6 mm e ladrilhos delicados RO Pentru grosimi până la 6 mm și plăci delicate SV För tjocklekar upp till 6 mm och för ömtåliga plattor SL Za debeline do 6 mm in občutljive ploščice SR Za debljinu do 6 mm i osjetljive pločice</p>	
<p><b>Art. FPZS15TP</b></p> 	 



# ISTRUZIONI D'USO



Obbligo



Divieto



Pericolo



*Leggere e conservare accuratamente.*

## 1 | PROFILATORE A SECCO

- **ESCLUSIVAMENTE** per la lavorazione di piastrelle in gres porcellanato e materiali lapidei.
- Solo per uso professionale e solo con utensili dedicati MONTOLIT.
- **ATTENZIONE!** Macchina pronta all'uso, non manomettere.
- Per una migliore finitura e maggiore durata dell'utensile avanzare lentamente e non forzare.

## 2 |

- Prima di lasciare l'Officina di produzione, la Vostra macchina è stata sottoposta ad approfonditi collaudi a garanzia della qualità, della sicurezza e dell'efficienza del prodotto.  
Seguendo attentamente le istruzioni contenute nel presente manuale, assicurerete alla Vostra macchina, in condizioni d'uso normali, una lunga durata.
- Prima di usare la macchina leggere attentamente questo manuale di istruzioni, al fine di evitare incidenti o malfunzionamenti.
- Non manomettere in alcun modo le protezioni e i ripari previsti dal costruttore.
- Non modificare in alcun modo nessuna parte della macchina.
- Eventuali modifiche possono essere apportate solo dal costruttore.
- Usare solo ricambi originali.
- Brevetti MONTOLIT declina ogni responsabilità in caso di inosservanza.

## 3 | SEGUIRE SCRUPolosAMENTE LE NORME VIGENTI IN MATERIA D'IGIENE E DI SICUREZZA SUL LAVORO

- E' obbligatorio l'uso dei dispositivi individuali di protezione dell'udito. Rumorosità > 85dB (A)
- Il livello di vibrazioni è stato rilevato secondo la norma EN60745.



Qualora la macchina non fosse correttamente mantenuta e/o gli utensili logorati o danneggiati, il livello di vibrazioni potrebbe differire.

## 4 | TARGHETTA IDENTIFICATIVA

The identification plate contains the following information and icons:

- Certificazione Europea di Sicurezza:** CE mark
- Disposizioni RAEE:** Recycled and environmentally friendly symbols
- Modello:** Art. TOPROFILE
- Diametro massimo della mola:** RPM max: \_\_\_\_\_ Ø max: \_\_\_\_\_
- Leggere le istruzioni:** Manual icon
- Dispositivi di protezione individuale:** Ear protection, gloves, eye protection icons
- Nome del costruttore:** MONTOLIT S.p.A.
- Numero di matricola:** Mat. N°: \_\_\_\_\_
- Anno di produzione:** Anno/Year: \_\_\_\_\_
- Max numero di giri:** Max number of revolutions
- Additional info:** BREVETTI MONTOLIT S.p.A., Via Turcoman, 25 • Cantello (VA) ITALIA • www.montolit.com

## 5 PREPARAZIONE - ALIMENTAZIONE ELETTRICA



**ATTENZIONE!**

- Verificare l'integrità del cavo e della smerigliatrice.
- Rispettare la tensione (V) e la frequenza (Hz) indicate sulla smerigliatrice.
- Per l'utilizzo di una prolunga, usare esclusivamente spina e presa IP67 (2P+T) e cavo 3 x 1,5mm<sup>2</sup> del tipo H07RN-F (lunghezza max 5m).
- Verificare la disposizione del cavo di alimentazione: non deve intralciare le manovre, non deve essere soggetto ad urti o danneggiamenti.
- Togliere l'allacciamento elettrico in ogni caso di manutenzione o per la sostituzione della mola diamantata.
- Evitare di forzare il motore durante la lavorazione.
- In ogni caso di disfunzioni riguardo la smerigliatrice, consultare un esperto o il nostro Ufficio Tecnico.

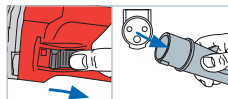

## 6 CORRETTO POSIZIONAMENTO ED UTILIZZO - DISPOSIZIONI DI SICUREZZA





- L'operatore deve posizionarsi in modo sicuro ed equilibrato e non distrarsi durante la lavorazione.
- L'operatore è sempre responsabile di incidenti che si possono verificare ad altre persone o alle loro proprietà.
- Non permettere ad altre persone di toccare la macchina o il cavo. Bisogna tenerle lontane dall'area di lavoro.
- È raccomandabile indossare guanti e scarpe con suola antiscivolo. Se si portano i capelli lunghi, bisogna raccogliarli o usare un berretto di protezione. Indossare occhiali di protezione.
- Utilizzare adeguate protezioni per l'udito.
- Non indossare capi d'abbigliamento larghi, oggetti o gioielli che possano restare impigliati nei dispositivi in movimento.
- L'area di lavoro deve essere piana, asciutta, libera da ostacoli, ben ventilata ed illuminata.
- Non utilizzare la macchina nelle vicinanze di liquidi infiammabili o di gas.
- Tenere il cavo al riparo dalle temperature elevate, dall'olio e dagli spigoli vivi.



### **IMPORTANTE!**

- Rispettare il senso di avanzamento indicato dalla freccia (da sinistra verso destra).
- Eseguire più passaggi fino a fine corsa.
- Per la realizzazione di Jolly 45° perfetti appoggiare e muovere TOPPROFILE sulla superficie della lastra, rispettando la direzione di avanzamento indicata sulla macchina. Per una maggiore velocità di esecuzione ed una migliore resa dell'utensile diamantato si consiglia di utilizzare prima un platorello diamantato.
- Lavorare sempre con aspirazione collegata.

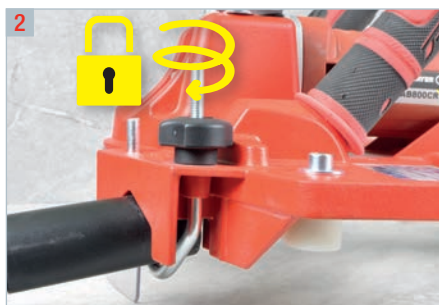
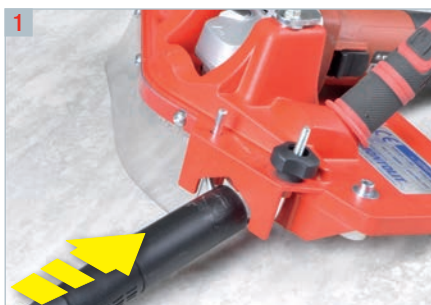

## 7 SOSTITUZIONE MOLA DIAMANTATA

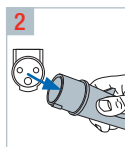
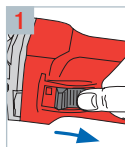

- Usare solo mole diamantate del diametro e del tipo stabilito dalla Brevetti MONTOLIT.



### **IMPORTANTE!**

- L'utensile diamantato ed il relativo sistema di fissaggio devono sempre essere in condizioni perfette.
- È pericoloso l'utilizzo di utensili diamantati con eccessiva usura, eccentricità e/o microfessurazioni.

## 8 SOSTITUZIONE PIASTRA IN NYLON

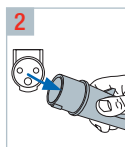
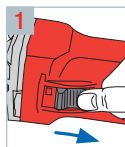

## 9 SOSTITUZIONE PATTINO FINECORSA

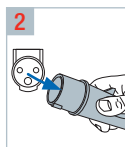
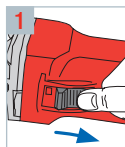



## 10 PULIZIA PERIODICA - MANUTENZIONE ORDINARIA

- Prima di procedere alla pulizia, alla manutenzione o alla riparazione della macchina, così come prima di effettuare il trasporto, la macchina va spenta e bisogna staccare la spina.
- Per la pulizia della macchina usare unicamente dei panni di stoffa.
- Per la pulizia della macchina non utilizzare acqua e/o prodotti detergenti.
- Esaminare periodicamente i cavi della macchina e, nel caso in cui siano danneggiati, farli riparare dal servizio tecnico autorizzato.
- Mantenere le impugnature asciutte, pulite e senza olio o grasso.

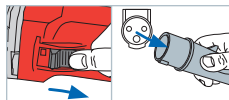

### **ATTENZIONE!**

Una protezione o un'altra parte danneggiata, va riparata correttamente o fatta sostituire dal servizio tecnico autorizzato, salvo che sia indicato diversamente in questo manuale d'istruzioni.

## 11 MESSA FUORI SERVIZIO

- Effettuare la pulizia periodica, la manutenzione ordinaria.
- Immagazzinare il tutto in un luogo asciutto, sicuro e lontano dalla portata dei bambini.

## 12 SMANTELLAMENTO DELLA MACCHINA

- Attenersi alle disposizioni locali per lo smaltimento di prodotti elettrici.
- Attraverso una rottamazione ecologica è possibile recuperare materiali pregiati.
- I componenti elettrici utilizzati per la costruzione sono in accordo alla normativa RoHS 2 (2011/65/CE).
- Per ulteriori informazioni contattare il nostro Ufficio Tecnico.



## 13 ACCESSORI

- La macchina viene fornita corredata di una chiave da utilizzarsi per il montaggio/smontaggio della mola e dal presente manuale d'uso e manutenzione.

## 14 GARANZIA

Validità 1 anno a partire dalla data di vendita (fattura o bolla di consegna o scontrino fiscale). Guasti derivanti da un uso non conforme o da normale usura sono esclusi dalla presente garanzia.

*Da sempre, la Brevetti MONTOLIT impiega e fornisce materiali di prima scelta. Si tratta di un impegno di serietà e moralità commerciale che eleva la Nostra Azienda al di sopra dello standard. Sicurezza e garanzia del prodotto costituiscono per noi motivo di vanto. Una realtà operativa che non è fatta solo di parole, ma anche di vere e proprie garanzie scritte. Infatti assicuriamo tutti i nostri prodotti contro i danni involontariamente cagionati in conseguenza di un fatto accidentale verificatosi per difetto di costruzione e fabbricazione del prodotto anche dopo la sua consegna e commercializzazione.*



Descrizioni ed illustrazioni s'intendono fornite a semplice titolo indicativo. La Casa si riserva il diritto, ferme restando le caratteristiche essenziali dei modelli qui descritti ed illustrati, di apportare ai propri prodotti, in qualunque momento e senza preavviso, le eventuali modifiche da essa ritenute necessarie a scopo di miglioramento o per qualsiasi esigenza di carattere costruttivo o commerciale. Si vieta ogni riproduzione totale o parziale dell'opera in qualsiasi formato e con qualsiasi mezzo o procedimento, sia meccanico, fotografico o elettronico, senza previa autorizzazione di Brevetti MONTOLIT S.p.A. Ciascuna delle succitate attività potrebbe condurre a conseguenti procedimenti penali.



# INSTRUCTIONS FOR USE



Obligation



Prohibition



Danger



*Read and store carefully.*

## 1 | DRY PROFILER

- **EXCLUSIVELY** for processing porcelain tiles and stone materials.
- Only for professional use and only with MONTOLIT dedicated tools.
- **CAUTION!** Machine ready for use. Do not tamper.
- For better finishing and longer life of the tool, move forward slowly and do not force.

## 2 |

- Before leaving the production workshop, your machine was subjected to in depth testing in order to guarantee the quality, safety and efficiency of the product.  
Carefully following the instructions contained in this manual will assure a long life for your machine under normal operating conditions.
- Carefully read this instructions manual before using the machine to avoid accidents or malfunctions.
- Do not tamper in any way with the protections and guards provided by the manufacturer.
- Do not modify any part of the machine in any way.
- Any changes can be made only by the manufacturer.
- Use original spare parts only.
- Brevetti MONTOLIT declines all responsibility in the event of non-compliance.

## 3 | SCRUPULOUSLY COMPLY WITH THE CURRENT REGULATIONS ON HYGIENE AND SAFETY IN THE WORKPLACE

- The use of suitable personal protective equipment for the hearing is required. Noise level > 85dB (A)
- The vibrations level was detected in accordance with the EN60745 standard.



If the machine is not correctly serviced and/or if the tools are worn or damaged, the vibrations level may differ.

## 4 | IDENTIFICATION PLATE

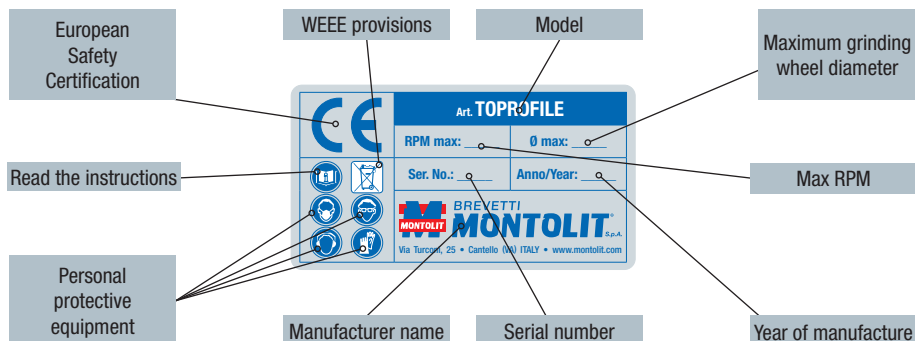



## 5 PREPARATION - ELECTRICAL POWER SUPPLY



**CAUTION!**

- Check the integrity of the grinder cable.
- Observe the voltage (V) and frequency (Hz) indicated on the grinder.
- To use an extension cord, use only an IP67 plug and socket (2P+T) and a 3 x 1.5 mm<sup>2</sup> H07RN-F type cable (max. length 5m).
- Check the position of the power supply cable: it must not interfere with manoeuvres and must not be subjected to shocks or damage.
- Remove the electrical connection in any cases of maintenance or replacement of the diamond grinding wheel.
- Do not force the motor during processing.
- In the event of grinder malfunctions, contact an expert or our Technical Office.

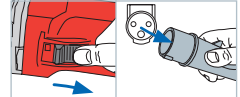

## 6 CORRECT POSITIONING AND USE - SAFETY DEVICES



**IMPORTANT:**  
always activate the vacuum during use.



- The operator must position himself in a safe and balanced manner and not become distracted during processing.
- The operator is always responsible for any accidents that may occur to other people or to their property.
- Do not allow other people to touch the machine or the cable. Keep all other persons away from the work area.
- We recommend wearing gloves and shoes with non-slip soles. Long hair must be gathered up or a protective cap must be worn. Wear protective goggles.
- Use adequate hearing protection.
- Do not wear loose clothing, objects or jewellery that could get caught in moving devices.
- The work area must be flat, dry, free of obstacles, well-ventilated and properly lit.
- Do not use the machine near flammable liquids or gas.
- Keep the cable away from high temperatures, oil and sharp edges.



### **IMPORTANT!**

- Observe the advancement direction indicated by the arrow (from left to right).
- Carry out several passes until the end limit.
- For perfect 45° Miter cuts, rest and move the TO-PROFILE on the surface of the slab, respecting the feeding direction indicated on the machine. It is advisable to first use a diamond pads for a greater speed of implementation and a better yield of the diamond tool.
- Always work with the vacuum connected.

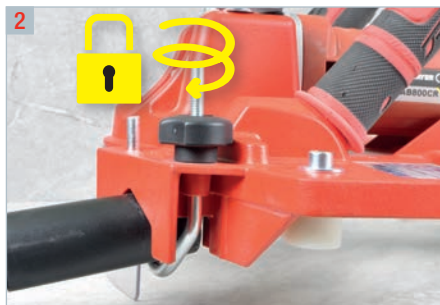



## 7 REPLACING THE DIAMOND GRINDING WHEEL

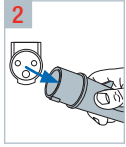
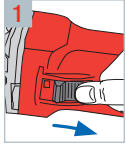

- Use only diamond grinding wheels that are the diameter and type established by the MONTOLIT Patents.



### **IMPORTANT!**

- The diamond tool and its corresponding fixing system must always be in perfect condition.
- Using diamond tools with excessive wear, eccentricity and/or micro-cracks is dangerous.

## 8 REPLACING THE NYLON PLATE

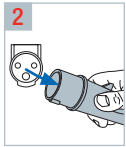
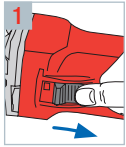

## 9 REPLACING THE END STOP RUNNER

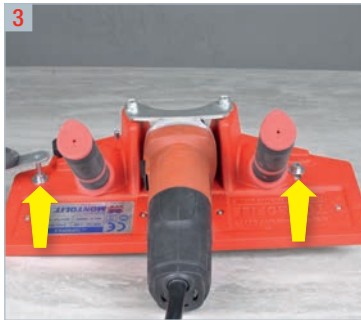
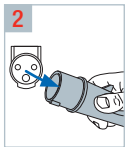
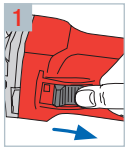

## 10 PERIODIC CLEANING - ROUTINE MAINTENANCE

- The machine must be switched off and the plug must be unplugged before cleaning, servicing or repairing the machine as well as before transport.
- Use only fabric cloths to clean the machine
- Do not use water and/or detergent products to clean the machine.
- Periodically check the machine cables; if they are damaged, have them repaired by authorised technical service.
- Keep the grips dry, clean and free of any oil or grease.

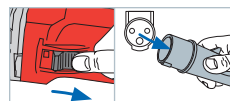

### **CAUTION!**

A protection or other damaged part must be repaired correctly or replaced by authorised technical service, unless otherwise indicated in this instructions manual.

## 11 DECOMMISSIONING

- Perform periodic cleaning and routine maintenance.
- Store all parts in a dry, safe place away from children.

## 12 DISMANTLING THE MACHINE

- Comply with local regulations for the disposal of electrical products.
- It is possible to recover valuable materials through environmentally friendly scrapping.
- The electrical components used for construction are in compliance with RoHS 2 (2011/65/EC).
- Contact our Technical Department for further information.



## 13 ACCESSORIES

- The machine comes with a key to be used for assembly/disassembly of the grinding wheel as well as this operation and maintenance manual.

## 14 WARRANTY

Valid for 1 year from the sell date (invoice or shipping bill or fiscal sales receipt).

Failures resulting from improper use or normal wear and tear are excluded from this warranty.

*Brevetti MONTOLIT always utilises and supplies first choice materials. It is this commitment to professionalism and commercial morality that elevates our company above the standard. Product safety and guarantee are a source of pride for us. An operational reality that is not made just of words, but also of real written guarantees. In fact, we insure all our products against damages that were involuntarily caused as a result of an accidental event that occurred due to a construction or manufacture defect on products even after their delivery and marketing.*



The descriptions and illustrations given are intended for reference purposes only. The Producer reserves the right, apart from the essential characteristics of the models described and illustrated herein, to make changes to its products deemed necessary for the purpose of improvement or for any constructive or commercial need at any time, and without notice. Any total or partial reproduction of the work in any format and by any means or procedure, be it mechanical, photographic or electronic, without the prior authorisation of Brevetti MONTOLIT S.p.A. is prohibited. Any of the aforementioned activities could as a result lead to criminal proceedings.



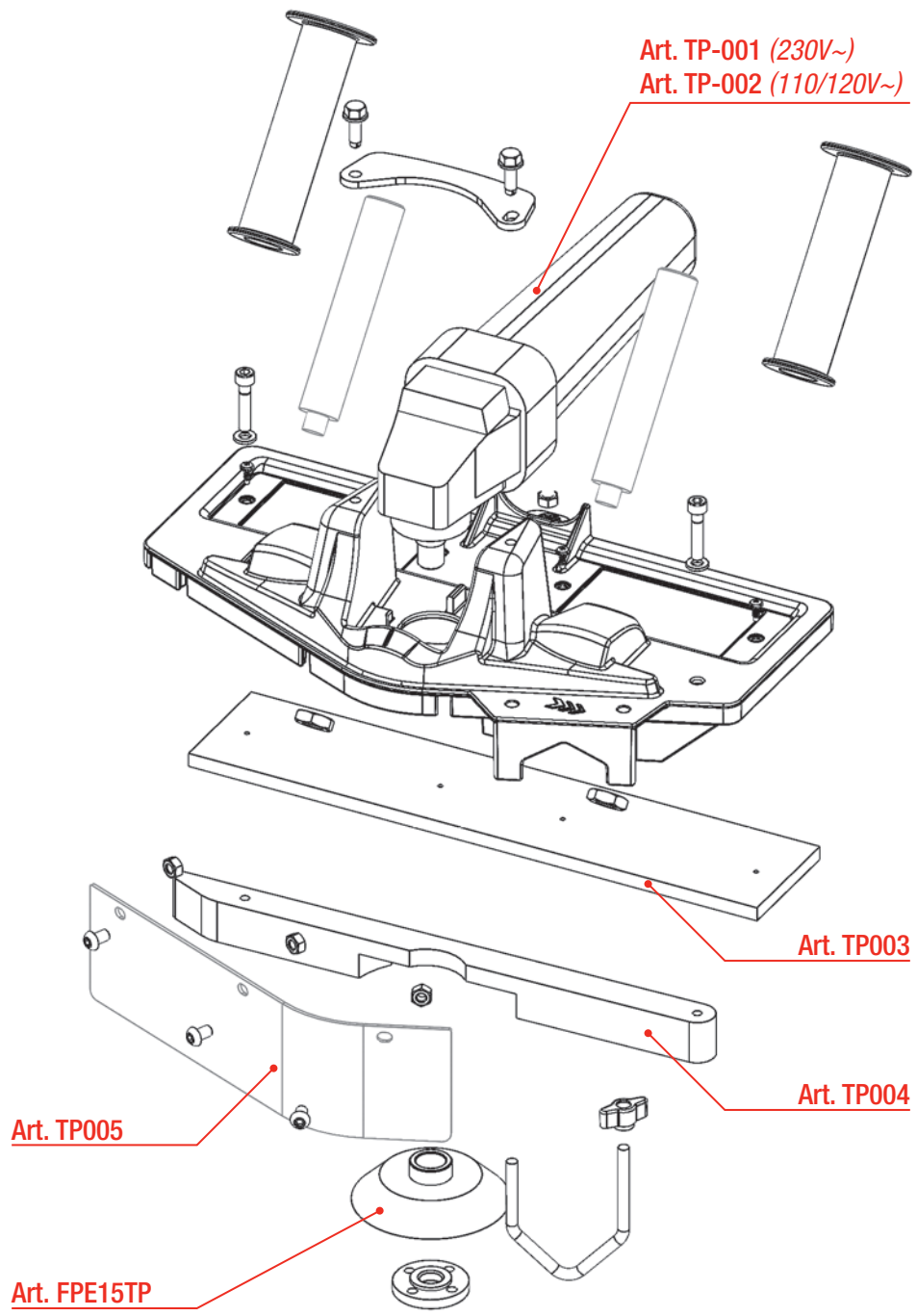

IT PARTI DI RICAMBIO EN SPARE PARTS FR PIÉCES DE RECHANGE DE ERSATZTEILE ES PIEZAS DE REPUESTO RU ЗАПАСНЫЕ ЧАСТИ CS NÁHRADNÍ DÍLY DA RESERVEDELE FI VARAOSAT  
HR REZERVNI DIJELOVI NO RESERVEDELER NL RESERVEONDERDELEN PL CZĘŚCI ZAMIENNE PT PEÇAS SOBRESSALENTES RO PIESE DE SCHIMB SV RESERVDLAR SL NADOMESTNI DELI SR REZERVI DELOVI



SINCE 1946

## **Brevetti Montolit S.p.A.**

*Sedi operative/ Company headquarters:*

Largo Cav. Montoli - 21050 Cantello (VA) Italy

Via Varese 4/A - 21050 Cantello (VA) Italy

*Sede legale/Legal head office:*

Via Turconi, 25 - 21050 Cantello (VA) Italy

Tel. ++39 0332 419 211

Fax ++39 0332 418 444

[www.montolit.com](http://www.montolit.com) - [info@montolit.com](mailto:info@montolit.com)