



OWNER'S MANUAL

CONCRETE VIBRATORS



BP-50a

- 1.2
- 1.8
- 2.4
- 3.2



BARTELL MORRISON INC.
375 ANNAGEM BLVD, MISSISSAUGA, ONTARIO, CANADA, L5T 3A7, 905-364-4200 FAX 905-364-4201
200 COMMERCE DRIVE, FREEHOLD, NEW JERSEY, USA, 07728 732-566-5400 FAX 732-566-5444

BARTELL MORRISON (USA) LLC

Doc. # OI-M09206
PB-M09206
Orig. Rel. 08/2010
Curr. Rev. - 03
Rev. Date - 06/2014

Bartell Morrison (USA) LLC
375 Annagem Blvd.
Mississauga, Ontario, Canada
L5T 3A7
Toll Free (N.A.): (866) 501-1683
Phone: (905) 364-4200
Facsimile: (905) 364-4201
www.bartellmorrison.com

Bartell Morrison (USA) LLC
200 Commerce Drive,
Freehold, New Jersey, USA
07735
Toll Free: 888-999-1570
Phone: (732) 566-5400
Facsimile: (732) 566-5444
www.bmiamerica.com

**ORIGINAL LANGUAGE OPERATING INSTRUCTIONS FOR
 FLEXIBLE SHAFT CONCRETE VIBRATORS**

© 2013 *Bartell Morrison Inc.*

No part of this work may be reproduced or transmitted in any form or by any means, electronic or mechanical, including photocopying and recording, or by any information storage or retrieval system without the prior written permission of Bartell Morrison Inc. unless such copying is permitted by federal copyright laws.

Address inquiries or reference permissions care of:

Bartell Morrison Inc.,
 375 Annagem Blvd.,
 Mississauga, Ontario,
 Canada, L5T 3A7

Revision	Date	Description	Approved by.
0	07/2010	Initial Release	RL
1	----	Part number updated.	AL
2	11/2013	Part numbers updated.	AL
3	06/2014	Address Update	AL

FLEXIBLE SHAFT CONCRETE VIBRATOR INSTRUCTION MANUAL

TABLE OF CONTENTS			
4		Quality Assurance	
5		Warranty Information	
MODELS 1.2, 1.8, 2.4, 3.2		MODEL BP-50a	
6-8	Power Tool Safety	9	Safety Precautions
9	Safety Precautions	10	Nameplates
13	Grounding Instructions	11-12	Safety Operations
14	Technical Specifications	15	Technical Specifications
16	Unit Assembly	17-19	Unit Assembly
20	Operating Instructions	21-22	Operating Instructions
24-25	Maintenance & Service	23	Refueling
27-28	Motor Assembly Parts List	26	Maintenance & Service
31-32	Core & Casing Replacement	29-30	Motor Assembly Parts List
		33	Vibration Tips
34	Flexible Shafts and Heads		

QUALITY ASSURANCE / MACHINE BREAK IN

The Morrison Concrete Vibrator is the product of extensive engineering development designed to give long life and unmatched performance.

You can help ensure that your Power Trowel will perform at top levels by observing a simple routing on first use. Consider your new Concrete Vibrator is like a new car. Just as you would break in a new car to the road or any new machine to the job, you should start gradually and build up to full use. Learn what your machine can do and how it will respond. Refer to the engine manufacturer's manual for run-in times. Full throttle and control may be used after this time period, as allowed by material. This will serve to further break in the machine on your specific application, as well as provide you with additional practice using the machine.

We thank you for the confidence you have placed in us by purchasing a Morrison Concrete Vibrator and wish you many years of satisfied use.

FLEXIBLE SHAFT CONCRETE VIBRATOR INSTRUCTION MANUAL

FLEXIBLE SHAFT CONCRETE VIBRATOR WARRANTY

- All products sold by Bartell Morrison Inc. and Bartell Morrison (USA) LLC (the “Company”) are warranted against defects in materials and/or workmanship; excluding normal wear on wearing components and components covered by a separate original manufacturers warranty, for a period of 24 months from the date of sale to the original end user purchaser provided that certain conditions have been met.

Conditions:

1. The equipment serial number has been registered with the Company or its approved dealers.
2. The equipment has been operated in an appropriate manner by qualified individuals.
3. The equipment has been properly maintained as per the instructions included in the Owner’s Manual.
4. All claims for warranty must be filed on proper forms and include the serial number of the equipment along with proof of purchase.

Any evidence of failure to meet these conditions may result in a denial of a warranty claim.

- Consideration of warranty claims will be at the sole discretion of the Company, or its authorized dealers, distributors, representatives or agents.
- The company may, at our discretion, repair or replace a part or the whole of the defective component or equipment.
- Our Warranty coverage is limited to the cost to repair or replace the defective portion of the equipment and a reasonable (as determined by the Company) amount of labour to conduct the repair or replacement. Under no circumstances shall the Company be liable for any additional or exceptional costs beyond the cost to repair or replace the defective portion of the equipment. The Company shall not be held accountable for; costs associated with travel to inspect or repair defective equipment, costs for transporting equipment at any facility other than one authorized by the Company or ancillary damage caused by or as a result of the defective equipment.
- Under no circumstances shall equipment be returned to the Company or its authorized dealers, distributors, representatives or agents without the approval of the company as evidenced by a Returned Goods Number. To obtain a Returned Goods Number, contact the factory or your authorized dealer, distributor, representative or agent.
- This warranty is for the sole benefit of the original end user purchaser and is not transferable to any other company or person.

GENERAL POWER TOOL SAFETY WARNINGS (FOR 1.2, 1.8, 2.4 AND 3.2 MODELS)

 **WARNING** Read all safety warnings and instructions. Failure to follow the warnings and instructions may result in electric shock, fire and/or serious injury.

Save all warnings and instructions for future reference.

The term “power tool” in the warnings refers to your mains-operated (corded) power tool.

1) Work area safety

- a) **Keep work area clean and well lit.** *Cluttered or Dark areas invite accidents.*
- b) **Do not operate power tools in explosive atmospheres, such as in the presence of flammable liquids, gases or dust.** *Power tools create sparks which may ignite the dust or fumes.*
- c) **Keep children and bystanders away while operating a power tool.** *Distractions can cause you to lose control.*

2) Electric safety

- a) **Power tool plugs must match the outlet. Never modify the plug in any way. Do not use any adapter plugs with earthed (grounded) power tools.** *Unmodified plugs and matching outlets will reduce risk of electric shock.*
- b) **Avoid body contact with earthed or grounded surfaces such as pipes, radiators, ranges and refrigerators.** *There is an increased risk of electric shock if your body is earthed or grounded.*
- c) **Do not expose power tools to rain or wet conditions.** *Water entering a power tool will increase the risk of electric shock.*
- d) **Do not abuse the cord. Never use the cord for carrying, pulling or unplugging the power tool. Keep cord away from the heat, oil, sharp edges or moving parts.** *Damaged or entangled cords increase the risk of electric shock.*
- e) **When operating a power tool outdoors, use an extension cord suitable for outdoor use.** *Use of a cord suitable for outdoor use reduces the risk of electric shock.*
- f) **If operating a power tool in a damp location is unavoidable, use a ground fault interrupter (GFCI) protected supply.** *Use of a GFCI reduces the risk of electric shock.*

FLEXIBLE SHAFT CONCRETE VIBRATOR INSTRUCTION MANUAL
GENERAL POWER TOOL SAFETY WARNINGS (FOR 1.2, 1.8, 2.4 AND 3.2 MODELS)

3) Personal safety

- a) **Stay alert, watch what you are doing and use common sense when operating a power tool. Do not use a power tool while you are tired or under the influence of drugs, alcohol or medication.** *A moment of inattention while operating power tools may result in serious personal injury.*
- b) **Use personal protective equipment. Always wear eye protection.** *Protective equipment such as dust mask, non-skid safety shoes, hardhat, or hearing protection used for appropriate conditions will reduce personal injuries.*
- c) **Preventing unintentional starting. Ensure the switch is in the off-position before connecting to power source and/or battery pack, picking up or carrying the tool.** *Carrying power tools with your finger on the switch or energizing power tools that have the switch on invites accidents.*
- d) **Remove any adjusting key or wrench before turning the power tool on.** *A wrench or a key left attached to a rotating part of the power tool may result in personal injury.*
- e) **Do not overreach. Keep proper footing and balance at all times.** *This enables better control of the power tool in the unexpected situations.*
- f) **Dress properly. Do not wear loose clothing or jewelry. Keep your hair, clothing and clothes away from moving parts.** *Loose clothes, jewelry or long hair can be caught in moving parts.*
- g) **If devices are provided for the connection of dust extraction and collection facilities, ensure these are connected and properly used.** *Use of dust collection can reduce dust-related hazards.*

4) Power tool use and care

- a) **Do not force the power tool. Use the correct power tool for your application.** *The correct power tool will do the job better and safer at the rate for which it was designed.*
- b) **Do not use the power tool if the switch does not turn it on and off.** *Any power tool that cannot be controlled with the switch is dangerous and must be repaired.*

GENERAL POWER TOOL SAFETY WARNINGS (FOR 1.2, 1.8, 2.4 AND 3.2 MODELS)

- c) **Disconnect the plug from the power source and/or the battery pack from the power tool before making any adjustments, changing accessories, or storing power tools.** *Such preventive safety measures reduce the risk of starting the power tool accidentally.*
- d) **Store idle power tools out of the reach of children and do not allow persons unfamiliar with the power tool or these instructions to operate the power tool.** *Power tools are dangerous in the hands of untrained users.*
- e) **Maintain power tools. Check for misalignment or binding of moving parts, breakage of parts and any other condition that may affect the power tool's operation. If damaged, have the power tool repaired before use.** *Many accidents are caused by poorly maintained power tools.*
- f) **Keep cutting tools sharp and clean.** *Properly maintained cutting tools with sharp cutting edges are less likely to bind and are easier to control.*
- g) **Use the power tool, accessories and tool bits, etc in accordance with these instructions, taking into account the working conditions and the work to be performed.** *Use of the power tool for operations different from those intended could result in a hazardous situation.*

5) Service









- a) **Have our power tool serviced by a qualified repairperson using only identical replacement parts.** *This will ensure that the safety of the power tool is maintained.*

FLEXIBLE SHAFT CONCRETE VIBRATOR INSTRUCTION MANUAL

⚠ DANGER: You will be KILLED or SERIOUSLY injured if you do not follow directions.

⚠ WARNING: You COULD be KILLED or SERIOUSLY injured if you do not follow directions.

⚠ CAUTION: You CAN be injured if you do not follow directions.

SAFETY PRECAUTIONS	
	⚠ CAUTION - Always wear approved PPE foot protection.
	⚠ CAUTION - Always wear approved PPE eye protection.
	⚠ CAUTION - Always wear approved PPE hand protection.
	⚠ CAUTION - Always wear approved PPE ear protection.
	⚠ WARNING - BURN HAZARDS - Engine will be hot during operation.
	⚠ WARNING - LETHAL EXHAUST GASES - Never operate equipment in a confined area or enclosed structure that does not provide ample free flow air.
	⚠ WARNING - ROTATING PARTS - Never operate equipment with guards removed. Keep fingers, hands, hair and clothing away from all moving parts to prevent injury.
	⚠ WARNING - EXPLOSIVE FUEL - Gasoline is extremely flammable. Keep all flames away. Do not smoke in presence of this equipment.
	⚠ DANGER - Before operating this concrete vibrator you must read and understand the contents of the operation manual.

FLEXIBLE SHAFT CONCRETE VIBRATOR INSTRUCTION MANUAL
BP-50a NAMEPLATE AND DECALS

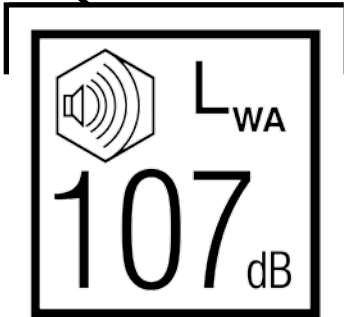
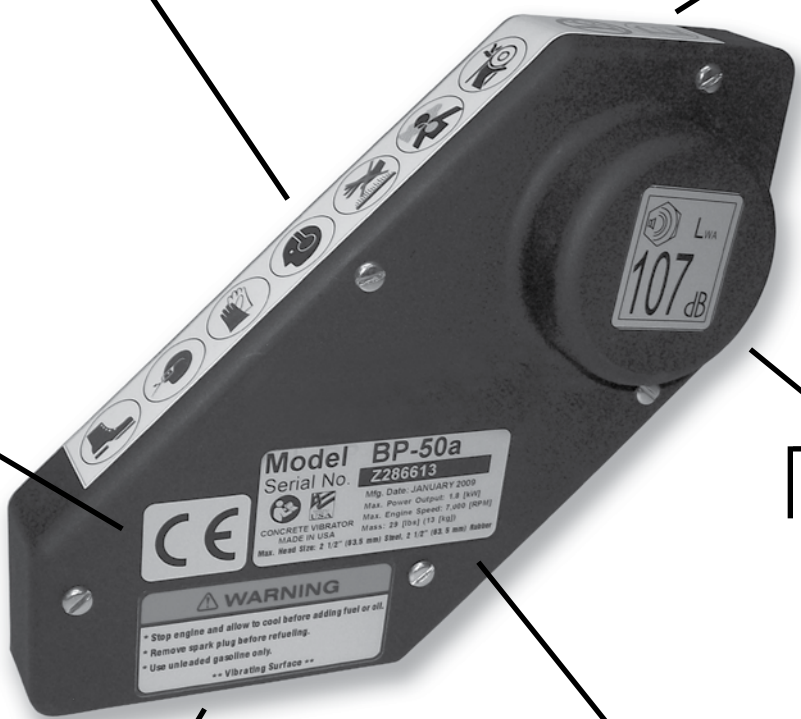
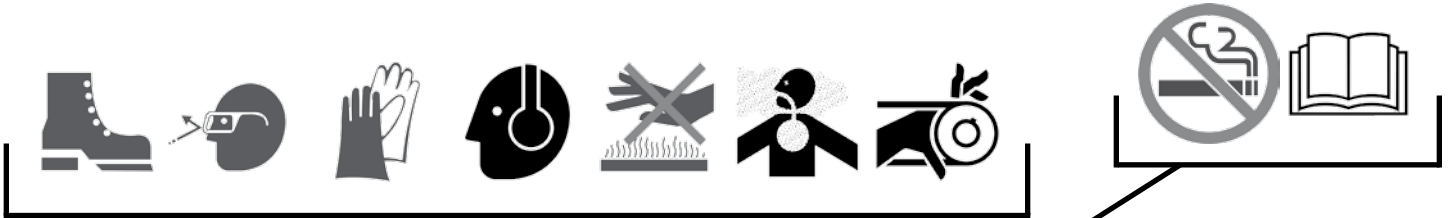

SAFE OPERATING INSTRUCTIONS (FOR BP-50a MODEL)

DANGER – READ ALL INSTRUCTIONS BEFORE OPERATING EQUIPMENT!

General Safety

1. Keep work area clean. Cluttered areas invite injury.
2. Consider work environment. Never operate in an enclosed area. Never operate when you are tired.
3. Never operate under the influence of drugs or alcohol.
4. Stay alert. Watch what you are doing. Use common sense. Do not operate when you are tired.
5. Do not operate unless you are properly trained.
6. Keep children and visitors way from work area.
7. Store idle tools. Do not leave tool unattended. When not in use, tool should be shut off and stored in a dry area and in a high or locked up place out of the reach of children.
8. Do not force tools. Use only recommended shaft length, core and head diameter for each power unit.
9. Use the right tool. Never use attachments or accessories not recommended by manufacturer. Never use tool for purpose not intended.
10. Dress properly. Safety glasses, safety boots, hearing protection, and a hard hat are required
11. Don't overreach. Keep proper footing and balance at all times.
12. Always allow engine to cool before performing maintenance.
13. Maintain tools with care.
 - Keep tools clean for better and safer performance.
 - Follow maintenance schedule.
 - Replace safety decals if they become lost or difficult to read.
 - Never operate without a guard.
14. Check for damaged parts.
 - Before further use of a tool, a guard or other part that is damaged must be carefully checked by a qualified person to determine that it will operate properly and perform its intended function.
 - Check tool for alignment of moving parts, binding of moving parts, breakage of parts or mounting, and any other conditions that may affect its operation. A guard or other part that is damaged should be properly repaired or replaced by an authorized service center unless otherwise indicated in this instruction manual.

SAFE OPERATING INSTRUCTIONS (FOR BP-50a MODEL)

Transporting Equipment

- Always shut down the engine and allow it to cool for at least 15 minutes before loading it on to a vehicle.
- Keep the engine level when transporting to reduce the possibility of fuel leakage. Turn the fuel valve to the OFF position.

Emergencies

- Always know the location of a first aid kit and a fire extinguisher.
- Always know the location of a phone and the phone numbers for the proper emergency services.
- Never disconnect safety devices from the equipment.

WARNING: READ ALL INSTRUCTIONS (FOR MODELS 1.2, 1.8, 2.4, 3.2)



WHEN SERVICING USE ONLY IDENTICAL REPLACEMENT PART

When using electric vibrators, basic safety precautions should always be followed to eliminate the risk of electricity shock, fire, personal injury and property damage.

Any tool not in proper working order, or one that develops a defect, should not be used until properly repaired.

**FOR ALL GROUNDED TOOLS
GROUNDING INSTRUCTIONS**

This tool should be grounded while in use to protect the operator from electric shock.

The tool is equipped with a 3-conductor cord and a 3-prong grounding type receptacle. The green (or green and yellow) conductor in the cord is the grounding wire. Never connect the green (or green and yellow) wire to a live terminal.

- If your unit is for use on less than 150 volts, it has a plug that looks like that shown in sketch [A].

- If your unit is for use on 150 to 250 volts, it has a plug that looks like shown in sketch [D].

- An adapter, shown in sketches [B] and [C] is available for connecting sketch [A] type plugs to 2-prong receptacles. The green coloured right ear, lug, or the like, extending from the adapter must be connected to a permanent ground, such as a properly grounded outlet box.

- No adapter is available for a plug as shown in sketch [D]

See page 5 for extension cord specs.

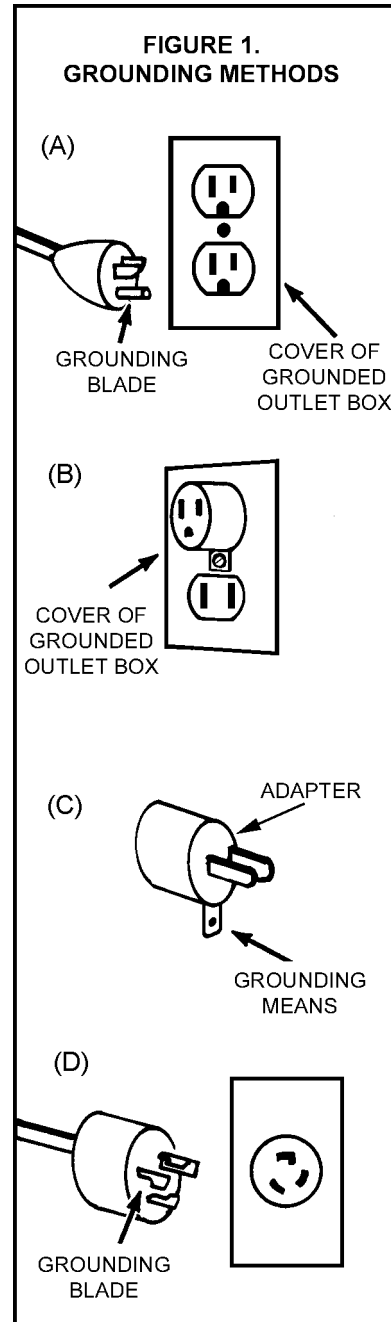

TECHNICAL SPECIFICATIONS

MODELS 1.2, 1.8, 2.4, 3.2



- Morrison Motors operate on 115V single phase 60-cycle (230V optional).
- They will also operate on 50-cycle AC current.
- All motors have AC/DC universal Windings.
- Frequences range from 10,000 to 12,000 vibrations per minute.

PLUGS AND RECEPTACLES FOR MORRISON POWER UNITS

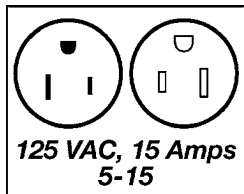

Morrison Models 1.2 and 1.8 have a male 15A plug (NEMA 5-15P), which plugs into a 15A female receptacle (NEMA 5-15R).

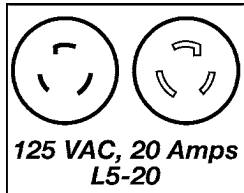

Morrison Models 2.4 and 3.2 have a male 20A plug (NEMA L5-20P), which plugs into a 20A female receptacle (NEMA L5-20R)

Extension Cords

- Use only 3-wire extensin cords that have 3-prong grounding-type plugs and 3-pole receptacles that accept the tool's plug. Repair or replace damaged cords.
- Always use the right extension cord, too light an extension cord can cause poor performance and motor burnout.

MINIMUM GAGE FOR EXTENSION CORDS, PER UL SPECIFICATIONS						
Morrison Model	Amperes @120V	50ft	100ft	150ft	200ft	300ft
1.2	9	14	14	12	10	8
1.8	15	14	12	10	8	8
2.4	17	14	12	8	8	8
3.2	19	12	12	8	8	8

TECHNICAL SPECIFICATIONS

MODEL BP-50a:



Vibration

- The weighted r.m.s. acceleration value to which the body is subjected does not exceed $0.5 \text{ [m/s}^2\text{]}$.
- The Hand-Arm-Vibration (HAV) value, a_{nv} , on the vibrator at $7.54 \pm 2 \text{ [m/s}^2\text{]}$ is somewhat higher.

Noise Emission





Sound Power Level, LWA = 107 [dB]

- Sound Pressure Level at operator's position is $96 \pm 6 \text{ [dB(A)]}$
- The peak C-weighted instantaneous sound pressure value at work stations, does not exceed 63 [PA] (130 [dB] in relation to $20 \text{ [}\mu\text{Pa]}$).

UNIT ASSEMBLY

MODELS 1.2, 1.8, 2.4, 3.2

 **IMPORTANT:** UNPLUG the motor and turn the SWITCH OFF before performing any maintenance, or fitting any components to the motor. 

Assembling Shaft to Motor:

1. Morrison's Quick Disconnect feature allows shaft attachment and removal from the power unit in the twist of a lever. The lightweight and bearingless coupling allows the job to be done in seconds without any tools.
2. This fitting will never rust or seize.



Assembling Head to Shaft:

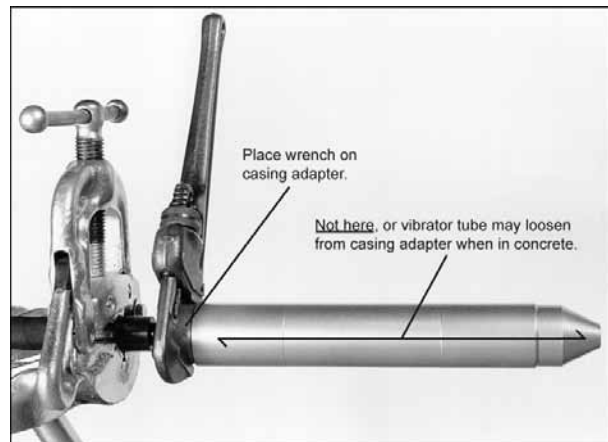

1. Clamp the head and casing coupling in a vice.
2. Coat threads with sealant such as Loctite or Permatex to prevent water from entering head.
3. Push core towards motor end to make certain it is still seated in the motor. Insert the inner core into head core adapter.
4. Thread head on and securely tighten the pipe wrench. See sketch for proper placement of pipe wrench.
5. When replacing head, make sure the entire head is removed from shaft or your new head will not attach.



NOTES:

- Flexible shafts are lubricated at the factory from one end. Attach the greased end to the motor (marked with an identification tag).
- Morrison Flexible Shafts are interchangeable on all Morrison Power Units, are reversible, and come with "Quick Change" Adapters.
- During the first few minutes of operation, the grease travels towards the head end spreading evenly along the shaft. During this break in period the shaft will turn slower than normal and could rattle and cause the motor to draw more current. After this initial break in period the unit will run smooth and quiet.

MODEL BP-50a

 **IMPORTANT:** Please do not attempt to attach or remove flexshaft while the unit is in operation. Instead, use the stop switch. 

1. Fill engine crankcase with oil:

- Place backpack on level bench.
- Fill until oil is about to run out of fill opening.

Failure to fill to this point may cause oil in level monitor to shut down engine when unit is tipped too far during operation.

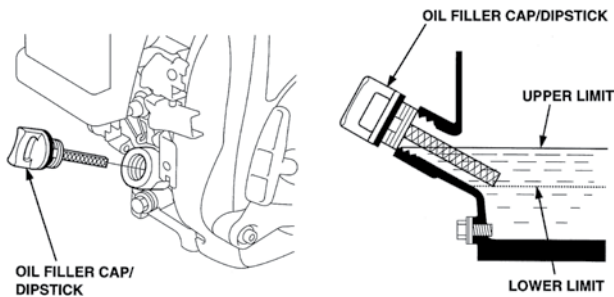

2. Attach the Throttle Arm to the Backpack:

- 2.1. Align inner core on the handle with core adapter on the Throttle Control Box, making sure flat on tube is on the bottom, and insert fully into throttle box.

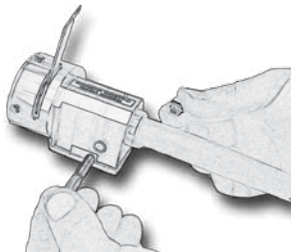
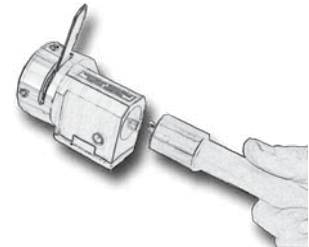

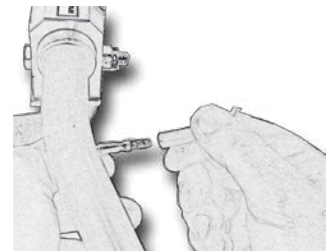

- 2.2. Insert supplied 1/4"-20" x 1 3/4" bolt on throttle control box, and attach supplied locknut on the other side. Using two 7/16" open end wrenches, tighten bolt secure.

- 2.3. Connect male electric connector from stop switch on handle to female electric connector from engine. Twist the connector as you push to make sure it is fully inserted.



MODEL BP-50a (CONTINUED)

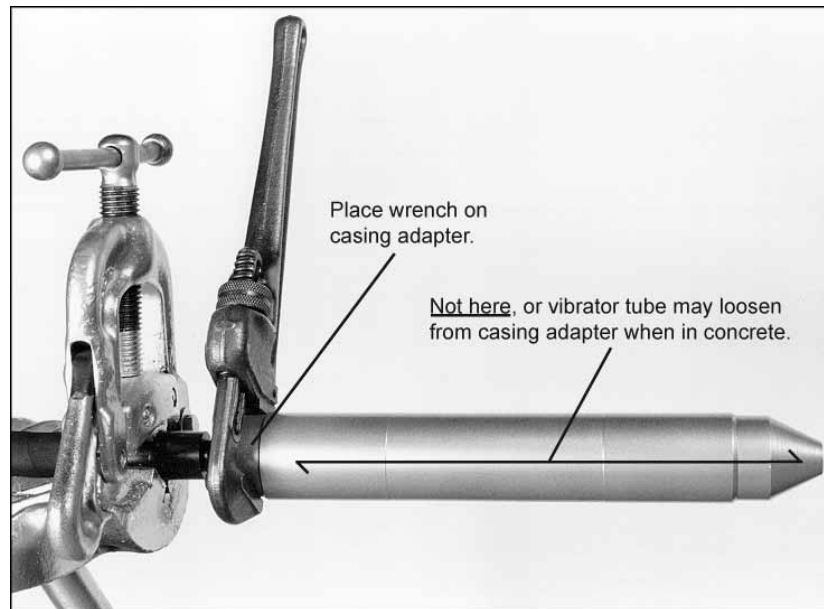

 **IMPORTANT:** Please do not attempt to attach or remove flexshaft while the unit is in operation. Instead, use the stop switch. 



3. Attach your Morrison vibrating head to the flexible shaft:

- 3.1. Clamp the head and casing coupling in a vice.
- 3.2. Coat threads with a sealant such as Loctite or Permatex to prevent water from entering head.
- 3.3. Push core towards motor end to make certain it is still seated in the motor.
- 3.4. Thread head on and securely tighten with pipe wrench. See sketch for proper placement of pipe wrench.
- 3.5. When replacing head make sure the entire head is removed from the shaft or your new head will not attach.

MODEL BP-50a (CONTINUED)

 **IMPORTANT:** Please do not attempt to attach or remove flexshaft while the unit is in operation. Instead, use the stop switch. 

1. Attach the flexible shaft to the engine:

Morrison's Quick Disconnect feature allows shaft attachment and removal from the engine with the twist of a lever. The lightweight and bearing-less coupling allows the job to be done in seconds without any tools. Set your Backpack unit on the ground and attach the flexshaft to the Q.D. adapter that is on your unit. It is the black piece with the black lever. Just simply turn the lever, insert the flexshaft with Q.D. coupler end into the Q.D. adapter and release the lever.



Notes:

- Use a flexible shaft with a length suitable for the job. Include allowing consideration for the operator, when selecting the length to help prevent any sharp bending which may put a kink in the casing liner as this will cut into the inner core and render the unit inoperable.
- Flexible shafts are lubricated at the factory from one end. Attach the greased end to the motor (marked with an identification tag).
- Morrison Flexible Shafts are all interchangeable on all Morrison Power units, are reversible, and come with supplied "Quick Change" adapters.
- During the first few minutes of operation, the grease travels towards the head end spreading evenly along the shaft. During this break in period the shaft will turn slower than normal and could rattle. After this initial break in period, the unit will run smooth and quiet.

OPERATING INSTRUCTIONS

MODELS 1.2, 1.8, 2.4, 3.2

- Match vibrator motor, shaft and head to the job. Select the largest vibrator suitable for the job. Select the shortest shaft possible to do the job to assure maximum power to the vibrator head.
- Avoid sharp bends in the flexible shaft for highest efficiency.

To turn unit ON actuate toggle switch to "I" position.

To turn unit OFF actuate toggle switch to "O" position.



- Insert vibrator vertically, allow it to sink into desired depth by its own weight; forcing it may lock between rebars.
- Hold the vibrator 5-15 seconds then slowly lift vibrator up, staying behind the trapped air's upward movement, allowing about 15 seconds for a 2 foot distance, to avoid retrapping air.
- A slight up and downward movement will close the hole formed by the vibrator.
- Withdraw the vibrator quickly when near the top, to prevent churning air into the top layer.
- Move vibrator and re-insert at a distance of 1 1/2 times the Radius of Action.
- Allow vibrator to penetrate 3 to 6 inches into the preceding layer to knit the two layers together to prevent "lift lines" when forms are removed.
- Try to limit pours to 2 feet high, so air has less resistance to escape.
- Do not use Vibrator to move concrete laterally as it can cause segregation (use a shovel). Place vibrator in center of mounds to knock them down.
- **Never** operate head out of the mix for more than a few minutes to prevent overheating. Wet concrete keeps head at proper operating temperature.

OPERATING INSTRUCTIONS

MODEL BP-50a

1. Your Morrison Backpack unit is equipped with a Honda 4-Stroke gas engine and has specific lubrication and fueling requirements. Please refer to the Honda Engine Owner's Manual enclosed.
2. Place the Backpack on an elevated flat level surface (such as a table). This will enable you to get the unit on your back after you start it.
3. To start the motor, brace it with one hand. Pull the recoil handle and guide the line back (just like a lawnmower engine).
4. Your Backpack unit attaches very much like a hiker's knapsack. Place your arms through the space between the shoulder straps and frame. Bring the abdominal straps to the front and make the connection accordingly. These are Velcro straps, a set for the chest and a second for the waist area.
5. To operate the rotary throttle, rotate the yellow throttle handle clockwise (toward the rabbit decal). The spring-loaded action will snap the throttle to maximum speed once the center point has been passed. Likewise, if the throttle is turned counterclockwise (towards the turtle on the decal) the throttle will snap back to idle. The Rotary Throttle has two positions: idle and maximum speed to ensure the vibrator head is running at the correct vibrations per minute. To warm up engine the throttle can be held in the middle position.

Note: If it is necessary to use this unit at variable speed, the spring can be removed. See diagram below.

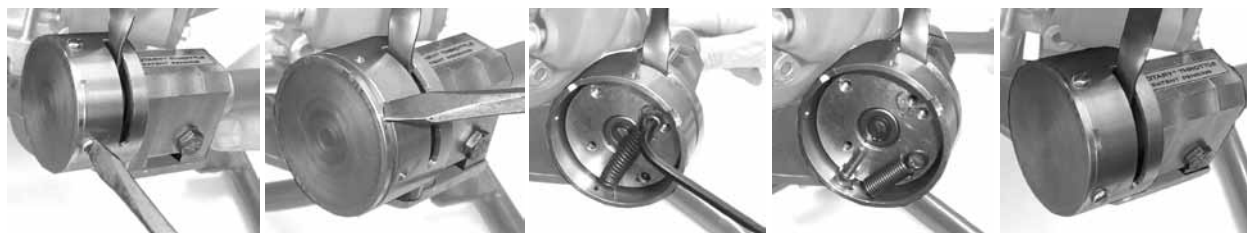

* To return to **Idle/Maximum Speed** operation, the steps above must be reversed, applying Red Loctite™ (#271) to the screw to prevent it from getting loose during operation.

7. This unit is equipped with a kill switch located under the throttle arm.

MODEL BP-50a (CONTINUED)

IMPORTANT:

- Never operate head out of the mix for more than a few minutes to prevent overheating. Wet concrete keeps head at proper operating temperature.

- Never lay backpack on its side. Stand upright; oil may enter cylinder and prevent rotation when starter is pulled.

To correct oil in the cylinder:

1. Remove the spark plug.

2. Pull starter rove a few times to pump oil out of cylinder.

3. Check oil level in crack Case, filling to top opening.

REFUELING

MODEL BP-50a

Recommended Fuel

Unleaded gasoline	U.S.	Pump octane rating 86 or higher.
	Except U.S.	Research octane rating 86 or higher.
		Pump octane rating 86 or higher.

This engine is certified to operate on unleaded gasoline. Unleaded gasoline produces fewer engine and spark plug deposits and extends exhaust system life.

⚠ WARNING ⚠

Gasoline is highly flammable and explosive, and you can be burned or seriously injured when refueling.

- Stop engine and keep heat, sparks, and flame away.
- Remove spark plug before refueling.
- Refuel only outdoors.
- Wipe up spills immediately

NOTICE

Fuel can damage paint and some types of plastic. Be careful to not spill fuel when filling the fuel tank. Damage caused by spilled fuel is not covered under the Honda Distributor's Limited Warranty.

Never use stale or contaminated gasoline or oil/gasoline mixtures. Avoid getting dirt or water in the fuel tank.

Occasionally you may hear a light "spark knock" or pinging" (metallic rapping noise while operating under heavy loads. This is no cause for concern.

NOTICE

Running the engine with persistent spark knock or pinging can cause engine damage.

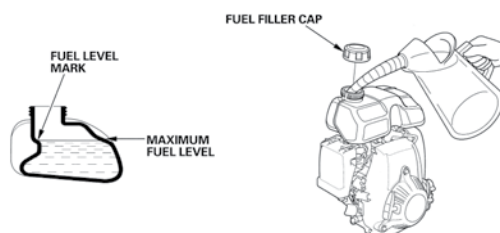

Running the engine with persistent spark knock or pinging is considered misuse and the Honda Distributor's Limited Warranty does not cover parts damaged by misuse.

1. With the engine stopped and on a level surface, remove the fuel filler cap and check the fuel level. Refill the tank if the fuel level is low.
2. Add fuel to the bottom of the fuel tank level mark on the fuel tank. Do not overfill. Wipe up the spilled fuel before starting the engine.



MAINTENANCE AND SERVICING

MODELS 1.2, 1.8, 2.4, 3.2

 **IMPORTANT: UNPLUG** the motor and turn the **SWITCH OFF** before performing any maintenance, or fitting any components to the motor. 

 **WHEN SERVICING USE ONLY IDENTICAL REPLACEMENT PARTS. MAINTENANCE SHOULD BE PERFORMED ONLY BY QUALIFIED PERSONNEL.**

MOTORS

- Wipe motor clean to prevent concrete build up.
- Clean intake and exhaust baffles to ensure airflow.
- Replace yellow filter material if clogged.
- When removing and replacing yellow filter make sure material is evenly replaced around the housing without large gaps.

Inspect the commutator through access port after every 100 hours of use. With the motor running, check for excessive sparking. If excessive sparking is present clean the commutator with a Morrison industrial rated commutator cleaner.

Electric Switch Replacement

- Remove all 4 screws that attach motor to motor frame using a 1/2" hex socket.
- Remove motor from motor mounts so switch is easily accessible.
- Remove all 4 screws that attach switch plate to motor and lift plate straight up.
- Remove rubber boot that holds switch plate to motor and lift plate straight up.
- Remove rubber boot that holds switch into plate, using a 5/8" deep socket.
- Remove screws that hold wire terminals to switch.
- Replace switch only with an identical replacement.
- To re-assemble motor, reverse removal instructions.



MODELS 1.2, 1.8, 2.4, 3.2 (CONTINUED)

FLEXIBLE SHAFTS

- Lubricate the flexible shaft assembly after every 40 hours of operation to prevent dry spots that cause overheating. Remove the inner core and wipe clean. Coat core with 1/16" of lubricant. Do not over lubricate since this will shorten the life of the shaft.
- Reverse shafts at regular intervals to extend service life.
- Replace worn or broken casing to prevent damage to core and head.
- Avoid sharp bends in flexible shaft, not only in operation but also when storing.
- Do not use flexible shaft to pull motor.
- Never install a new core in a kinked casing or a kinked core in a new casing. The parts will be ruined instantly.

Electric Switch Replacement

- All Heads are factory sealed so they require no maintenance.
- After using Rubber Heads always wash or vibrate head in water as hardened concrete will prevent cooling and damage epoxy coating on rebar.

MODEL BP-50a



IMPORTANT: Always STOP the Engine, disconnect the spark plug wire and secure it away from the spark plug BEFORE any maintenance is performed.



WHEN SERVICING USE ONLY IDENTICAL REPLACEMENT PARTS. MAINTENANCE SHOULD BE PERFORMED ONLY BY QUALIFIED PERSONNEL.

HONDA GX50 ENGINE

- Please refer to the enclosed engine manufacturer's manual.
- Inspect guards regularly. Do not operate unit without belt guard.
- Inspect safety warnings for condition and eligibility and replace if necessary.
- Check operation of controls, particularly those for stopping the machine and repair any faults before use.

FLEXIBLE SHAFTS

- Lubricate the flexible shaft assembly after every 40 hours of operation to prevent dry spots that cause overheating. Remove the inner core and wipe clean. Coat core with 1/16th layer of lubricant. Do not over lubricate since this will shorten the life of the shaft.
- Reverse shafts at regular intervals to extend the service life.
- Replace worn or broken casing to prevent damage to core and head.
- Avoid sharp bends in flexible shaft, not only in operation but also when storing.
- Don't use flexible shaft to pull the motor.
- Never install a new core in a kinked casing or a kinked core in a new casing. The parts will ruin instantly.

FLEXIBLE SHAFTS

- All Heads are factory sealed so they require no maintenance.
- After using Rubber Heads always wash or vibrate head in water, hardened concrete will prevent cooling and damage epoxy coating on rebar.

MOTOR ASSEMBLY - PARTS LIST

MODELS 1.2, 1.8, 2.4, 3.2

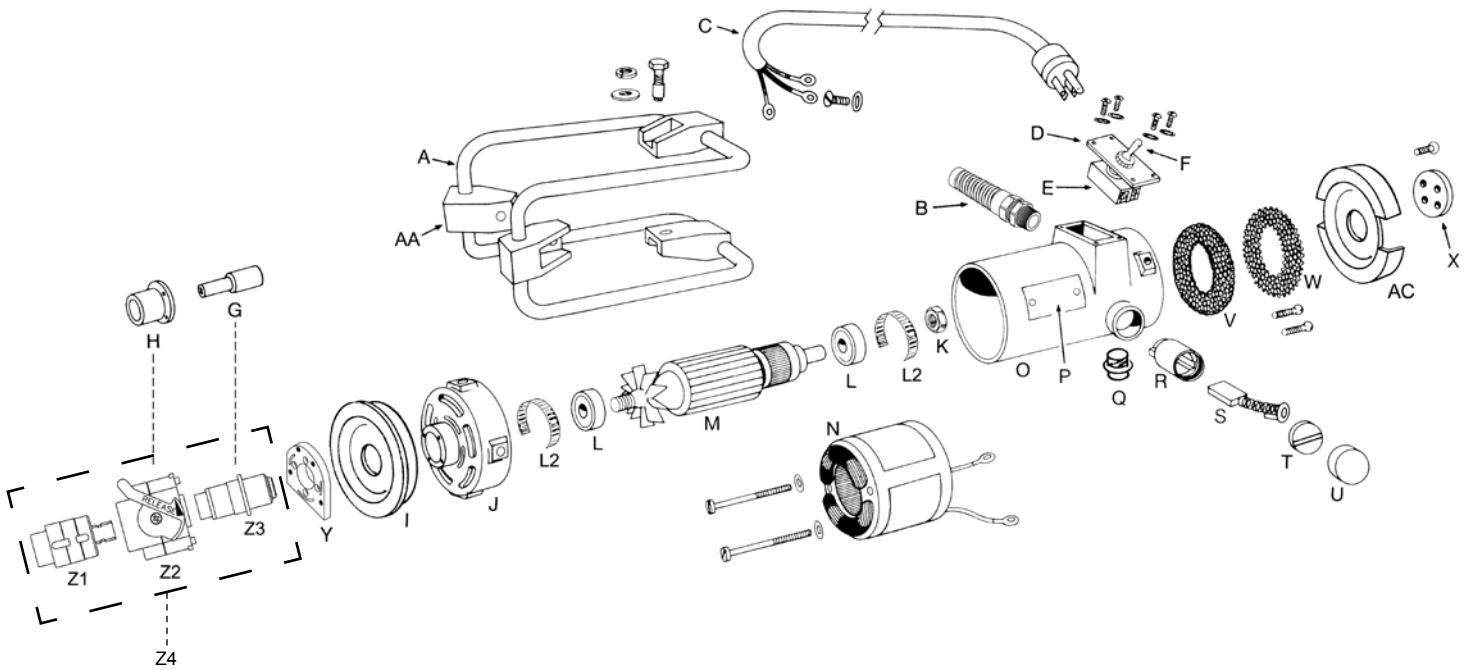

MOTOR ASSEMBLY - PARTS LIST

MODELS 1.2, 1.8, 2.4, 3.2

****Please use prefix 81 when ordering.****

Ref. #	Description	MODEL 1.2 PART #	MODEL 1.8 PART #	MODEL 2.4 PART #	MODEL 3.2 PART #	MOTOR STYLE	G.CORE ADAPTER	H.CASING ADAPTER	K. NUT
A	FRAME ASSEMBLY	6825EW1	6825EW2	6825EW2	6825EW3	D	271F1	270AA1	72AJ1
AA	SHOCK MOUNT	319B2	319A2	319A2	319A2	JE	271S1	270M1	72AJ1
AC	RAIN CAP	---	---	---	329K1	QE	271CX1	270EX1	72AJ1
B	STRAIN RELIEF ASSEMBLY	334D2	334D2	334D2	334D2	CE	271FK1	270LB1	72AJ1
C	CORD ASSEMBLY	174BF1	174BF1	174BG1	174BG1	DP	271FA1	270KL1	72AJ1
D	SWITCH PLATE ASSEMBLY	102A12	102A12	102A12	102A12	ST	271M1	270S1	72AJ1
E	SWITCH	177A1	177A1	177A1	177A1	S	271C1	270N1	72AJ1
F	RUBBER BOOT (SWITCH)	34A1	34A1	34A1	34A1	SS	271K1	270Y2	72AJ1
G & H	CORE & CASING ADAPTER	SEE CHART	---	---	---	MM	271N3	270W1	72AH1
I	BAFFLE ASSEMBLY	46G1	46G2	46G2	46G3	MV	271H1	270AC1	72AH1
J	END BELL	324A1	324B1	324B1	324C1	M	271L1	270K1	72AH1
K	NYLON INSERT LOCKNUT	SEE CHART	---	---	---	MK	271CP1	270EC1	72AJ1
L	BEARINGS (2)	207R1	207S1	207S1	207S1	OZ	271N3	270P2	72AH1
L2	TOLERANCE RING (2)	173D1	173E1	173E1	173E1	DVS	271N4	270P1	72AJ1
M 115V	ARMATURE 115V	6825B1	6825C1	6825D1	6825E1	RL	271D2	270AB1	72AJ1
230V	ARMATURE 230V (Non-UL)	N/A	6825C2	6825D2	6825E2	R	271P1	270AB1	72AJ1
N 115V	FIELD 115V	221A1	221B1	221C1	221D1	T	271N2	270T1	72AJ1
230V	FIELD 230V (Non-UL)	N/A	221F1	221G1	221H1	TT	271V1	270AD1	72AJ1
O	HOUSING	368J1	368K1	368K1	368L1	V	271N4	270R1	72AJ1
P	NAME PLATE	NOT SOLD	---	---	---	W	271D1	270V1	72AH1
Q	ACCESS PORT PLUG	444C1	444C1	444C1	444C1	WW	271D1	270X1	72AH1
R	BRUSH HOLDER	178A1	178A2	178A2	178A3	WS	271EV1	270V1	72AH1
S	BRUSH	240A1	240A2	240A2	240A3	WL	271EV1	270X1	72AH1
T	SCREW CAP	329B1	329B2	329B2	329B2				
U	PROTECTIVE CAP, THREADED	329E1	329E2	329E2	329E2				
V	FILTER	47A1	47A2	47A2	47A3				
W	FILTER SCREEN	49A1	49A2	49A2	49A3				
X	COVER	346B1	346B1	346B1	346B1				
Y	Q.D. SPACER	462AM1	462AM1	462AM1	462AM1				
Z1	MORRISON Q.D. CASING COUPLING ASSY.	217A1	217A1	217A1	217A1				
Z2	MORRISON Q.D. CASING ADAPTER ASSY.	270MX1	270MX1	270MX1	270MX1				
Z3	MORRISON Q.D. CORE ADAPTER ASSY.	271GT1	271GT1	271GT1	271GT1				
Z4	MORRISON Q.D. KIT	OZQDKIT1.2	OZQDKIT1.8	OZQDKIT2.4	OZQDKIT3.2				

NOTE:

CORD ASSEMBLY [PART No. 174J1] IS "TWIST LOCK"
TYPE - NEMA CODE P.

MOTOR ASSEMBLY - PARTS LIST

MODEL BP-50a

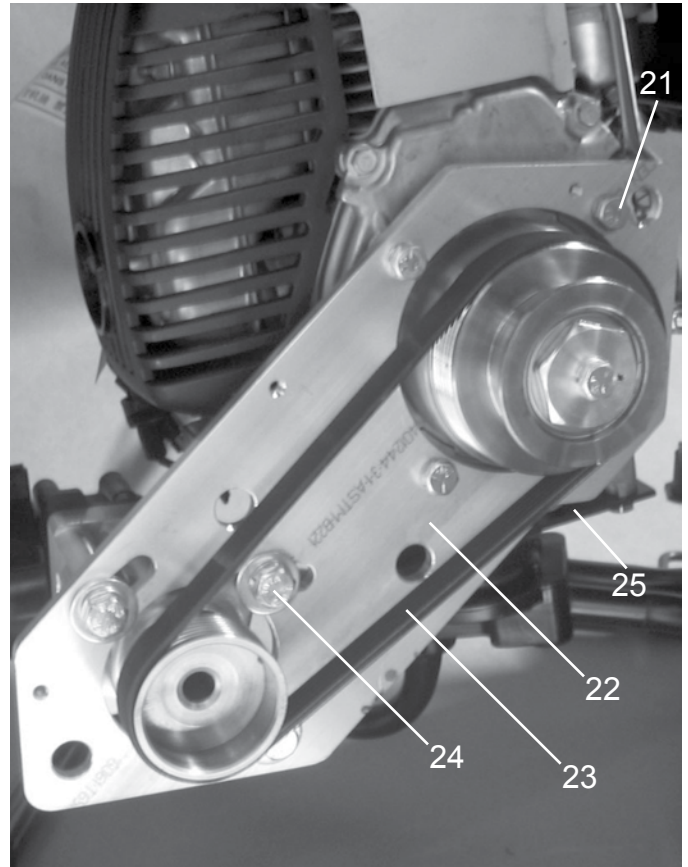

MOTOR ASSEMBLY - PARTS LIST

MODEL BP-50a

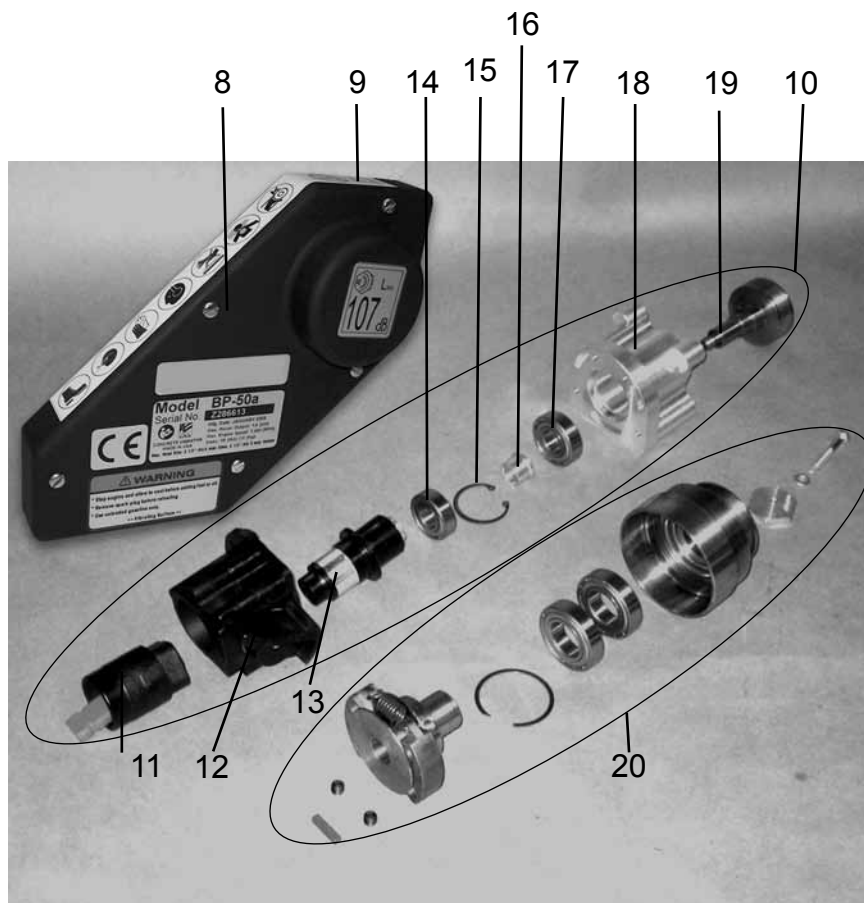

Ref. #	Description	Part #
1	BP-31, BP-35, BP-40, BP-50 FRAME	374AR1
2	HONDA GXH-50 4-STROKE ENGINE	6850X1
2a	BP-50 RECOIL STARTER	RECOIL50
3	BP-50 (RT) SPIDER ASSY.	170D2
4	BP RUBBER SHOCK MOUNTS (3)	319D1
5	BP-50 ROTARY THROTTLE COMPLETE	31G1
5a	BP-50 THROTTLE ARM ASSY.	316A1
5b	BP-50 ROTARY THROTTLE CONTROL BOX.	399A1
6	BACKPACK PAD With VELCRO STRAP	45B1
7	BACKPACK SHOULDER STRAP ASSY.	478C1
8	SCREW & RETAINING WASHER (5)	111N106
9	BP-50 BELT GUARD	346P1
10	BP-50 COMPLETE DRIVEN BLOCK ASSY.	6750G1
11	MORRISON QD CASING COUPLING ASSY.	217A1
12	MORRISON CASING ADAPTER ASSY.	270MX1
13	MORRISON QD CORE ADAPTER ASSY.	271GT1
14	BEARING (6202-ZZ)	207R3
15	SNAP RING, BEARING HOUSING	398D1
16	BP-50 BEARING BLOCK SPACER	462BE1

Ref. #	Description	Part #
17	BEARING (6203-ZZ)	207R4
18	BP-50 BEARING HOUSING ASSY.	398D1
19	BP-50 DRIVEN PULLEY	265K1
20	BP-50 COMPLETE CLUTCH ASSY.	363A1
21	TRANS. PLATE SCREW 1/4-28 X 3/4" (4)	58B3
22	BP-50 TRANSMISSION MOUNTING PLATE	386CK
23	BP-50 POLY-V BELT, 6 GROOVE	37D3
24	BEARING BLOCK HOUSING SCREWS (3)	58A28
25	BP-50a ENGINE BASE ASSY.	386CL2

MAINTENANCE AND SERVICING

MODELS 1.2, 1.8, 2.4, 3.2

IMPORTANT: UNPLUG the motor and turn the SWITCH OFF before performing any maintenance, or fitting any components to the motor.

TO IDENTIFY CORE AND CASING ADAPTERS

Morrison concrete vibrator motors can be fitted with different adapters to follow other manufacturers flexible shafts and heads used with Morrison motors. The style of your Morrison motor can be determined from the nameplate, with some having Left Hand rotation and some having Right Hand rotation. Below are shown some, but not limited to, of the styles available.

Attach to Brush End of Motor

DV Dunride Style

JE, QE Dreyer Style

MK Mikasa Style

R, RL Remington Style

SS, ST Stow, Wacker Styles

T Stone, Thor Styles

V Viber Styles

Note: Armature threads are RH this side of mirror.



Attach to Fan End of Motor

MM Master Style

OZ Oztec Style

W, WW Wyco Style

WS, WL Wyco Style

Shown Morrison Standard Quick Disconnect (QD).

Note: Armature threads are LH this side of mirror.

MODELS 1.2, 1.8, 2.4, 3.2

TO REPLACE CORE AND CASING ADAPTERS

1. Remove casing adapter by removing the 4 screws from the flange of the adapter.
2. If your motor has a Morrison style Q.D. (quick disconnect), you must also remove the Q.D. spacer located immediately behind the Q.D. Casing adapter.
3. Remove the 4 screws that attach the switch plate to the motor, and pull switch plate to the side. On some models the motor has to be removed from frame to move switch plate out of the way.
4. Insert a 3/16 drift through the port and into the hole in the armature shaft. This hole is located behind the commutators on the armature (as shown in photo detail below)
5. The core adapter normally will unscrew off the armature. If it is attached to the fan end of the motor, turn the adapter clockwise to remove it. If on the brush side of the motor, then turn counter-clockwise. To remove a Morrison Q.D. core adapter, use a channel lock on the aluminum surface and turn clockwise to remove it.
6. When changing styles of adapters on your motor, refer to the photo at the top of the page. Styles "OZ" (threaded or 'Q.D'), "MM", "W", "WL" and "WS" will be attached to the fan side of the motor. All other styles mount on the brush side of the motor.
7. If there is a cover, the black disc with 4 screws where you need to mount your new adapters, simply remove it and attach this cover to the opposite side of the motor. This will help prevent concrete from entering the motor and damaging the internal components.
8. Attach your new core adapter by turning accordingly. For styles "OZ", "MM", "W", "WW", "WL" & "WS" turn counter-clockwise onto the fan side. All other styles attach clockwise onto the brush side.
9. Remove the 3/16 drift, and re-attach the switch plate.
10. Replace the old baffle if it does not have the cut-out to accommodate the lever of the Morrison Q.D. casing adapter.
11. Attach the Morrison Q.D. spacer plate ONLY if installing the Morrison style Q.D. systems!
12. Attach the new casing adapter with the 4 screws.

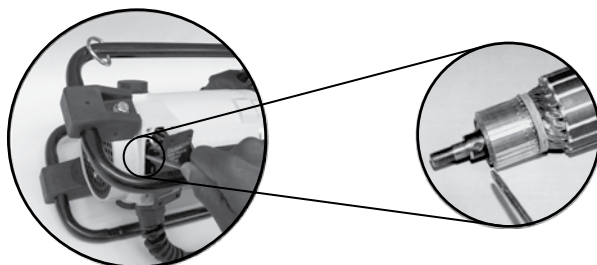

MODEL BP-50a



- Match vibrator motor, shaft and head to the job. Select the largest vibrator suitable for the job. Select the shortest shaft possible to do the job to assure maximum power to the vibrator head.
- Avoid sharp bends in the flexible shaft for highest efficiency.
- Insert the vibrator vertically, allow it to sink to the desired depth by its own weight; forcing it may lock it between rebars.
- Hold the vibrator 5-15 seconds then slowly lift vibrator up, staying behind the trapped air's upward movement, allowing about 15 seconds for a 2 foot distance, to avoid retrapped air.
- A slight up and downward movement will close the hole formed by the vibrator.
- Withdraw the vibrator quickly when near the top, to prevent churning air into the top layer.
- Move vibrator and re-insert at a distance of 1 1/2 times the Radius of Action.
- Allow the vibrator to penetrate 3 to 6 inches into the preceding layer to knit the two layers together to prevent "lift lines" when forms are removed.
- Try to limit pours to 2 feet high, so air has less resistance to escape.
- Do not use vibrator to move concrete laterally as it can cause segregation (use a shovel). Place vibrator in center of mounds to knock them down.
- **Never** operate head out of the mix for more than a few minutes to prevent overheating. Wet concrete keeps head at proper operating temperature.

MATCHING FLEXIBLE SHAFTS AND HEADS

MODELS 1.2, 1.8, 2.4, 3.3 AND BP-50a

****Please use prefix 81 when ordering.****

FLEXIBLE SHAFTS				HEADS		
Length (Ft.)	Shaft Assy. Part #	Inner Core Part #	Outer Casing Part #	Vibrator Heads Dia. (In)	Part #	
3	FSP 03 OZ	CP 03 OZ	CASP 03 OZ	Can be used with any length Pencil Shaft on the left.		
6	FSP 06 OZ	CP 06 OZ	CASP 06 OZ	3/4	HP 075 OZ	
9	FSP 09 OZ	CP 09 OZ	CASP 09 OZ			
11	FSP 11 OZ	CP 11 OZ	CASP 11 OZ			
15	FSP 15 OZ	CP 15 OZ	CASP 15 OZ			
20	FSP 20 OZ	CP 20 OZ	CASP 20 OZ			
						Can be used with any length Standard Shaft on the left.
2	FS 02 OZ	C 02 OZ	CAS 02 OZ	Steel Heads	1	H 100 OZ
					1-1/4	H 125 OZ
5	FS 05 OZ	C 05 OZ	CAS 05 OZ		1-1/2	H 150 OZ
7	FS 07 OZ	C 07 OZ	CAS 07 OZ		1-3/4	H 175 OZ
10	FS 10 OZ	C 10 OZ	CAS 10 OZ		2	H 200 OZ
12	FS 12 OZ	C 12 OZ	CAS 12 OZ		2-1/2	H 250 OZ
14	FS 14 OZ	C 14 OZ	CAS 14 OZ	Rubber Heads	1-7/8	HR 150 OZ
16	FS 16 OZ	C 16 OZ	CAS 16 OZ		2-1/2	HR 188 OZ
18	FS 18 OZ	C 18 OZ	CAS 18 OZ		2-3/4	HR 275 OZ
21	FS 21 OZ	C 21 OZ	CAS 21 OZ		2-3/4	HSR 275 OZ
					2-3/4 Short	

Standard Shafts normally coupled to 41 feet, successful lengths to 65 feet. Pencil Shafts cannot be coupled together, but can be lengthened, by coupling to a Standard Shaft with Coupling.

RECOMMENDED MAXIMUM HEAD SIZE

MODEL	AMPERES	HP	STEEL	"RUBBER"
1.2	9	1 1/4	1 1/2"	None
1.8	15	1 3/4	1 3/4"	None
2.4	17	2 1/4	2"	2 3/4" Short
3.2	19	3 1/4	2 1/2"	2 3/4"
BP-50	---	2 1/2	2 1/2"	2 1/2", 2 3/4" Short



BARTELL

BARTELL MORRISON INC.



BARTELL MORRISON INC.

375 Annagem Blvd.
Mississauga, Ontario, Canada
L5T3A7

Toll Free: 866-501-1683

Local: 905-364-4200

Fax: 905-364-4201

www.bartellmorrison.com

BARTELL MORRISON (USA) LLC.

200 Commerce Dr.
Freehold, New Jersey, USA
07728

Toll Free: 888-999-1570

Local: 732-566-5400

Fax: 732-566-5444

www.bmiamerica.com

BARTELL morrison **SPE** **Innovatech™**
CONCRETE EQUIPMENT CONCRETE EQUIPMENT Surface Preparation Equipment

