



'Whatever It Takes'

Operator's Manual

CC1200 Concrete Saw
CC1300XL Concrete Saw
Part Number: 1801227

(800) 321-5336

www.diamondproducts.com

Table of Contents

Safety Precautions.....	1	Starting the Engine/Motor	19
Safety Alerts	1	Stopping the Engine/Motor.....	20
Proposition 65.....	1	Concrete Cutting.....	20
Spark Arrester Requirement	1	Helpful Hints Prior to Cutting.....	20
Respiratory Hazards	1	Tasks Prior to Cutting.....	20
General Safety	2	Making a Cut.....	21
Blade Safety	2	Continuing a Partial-Cut.....	21
Blade Guard Safety	3	Finishing a Cut	21
Fuel Safety.....	3	Maintaining the CC1200 and CC1300XL	23
Engine/Motor Safety	3	Tasks Prior to Maintenance	23
Cutting Safety	4	Maintenance Overview	23
Belt Safety	4	Daily/Regularly	23
Transporting Safety	4	Handlebars	23
Lifting Safety	4	Part Lubrication.....	23
Introducing the CC1200 and CC1300XL	5	Blade Shaft.....	23
CC1200 Components	5	Axle	24
CC1300XL Components.....	6	Adjustment Shaft.....	24
Controls	7	Inner Blade Flange	24
CC1200 Dimensions.....	8	Installing the Inner Blade Flange	24
CC1300XL Dimensions	9	Removing the Inner Blade Flange	24
Specifications.....	10	Wheels.....	24
Operating the CC1200 and CC1300XL	13	Front Wheels.....	24
Handlebars	13	Rear Wheels	25
Adjusting the Handlebars	13	Blade Drive Belts	25
Front Pointer	13	Tensioning the Blade Drive Belts.....	25
Adjusting the Front Pointer	13	Replacing the Blade Drive Belts	26
Diamond Blades	14	Engine/Motor	26
Inspecting the Blade	14	Cleaning the Engine/Motor.....	26
Blade Speed	14	Storing	26
Wrench	14	Disposal.....	27
Installing the Blade	14	Index.....	29
Removing the Blade	15	Serial Tags.....	29
Blade Guard.....	16	Saw Serial Tag.....	29
Installing the Blade Guard	16	Engine/Motor Serial Tag	29
Removing the Blade Guard	16	Daily Maintenance Task Chart.....	30
Flange Guard.....	17	Belt Tension Settings.....	31
Installing the Flange Guard	17	Troubleshooting	32
Removing the Flange Guard	17	References	33
Water System	17	Additional Resources.....	33
Water Valve and Supply Hose(s)	17		
Water Tank	17		
Handwheel.....	17		
Raising the Saw.....	18		
Lowering the Saw	18		
Fuel System (Gas Models)	18		
Fueling the Saw.....	18		
Storage.....	18		
Engine/Motor	19		
Engine Governor (Gas Models).....	19		
Tasks Prior to Starting the Engine/Motor	19		

Safety Precautions

Operate the CC1200 Concrete Saw and the CC1300XL Concrete Saw and all of their components according to this manual. Failure to comply with and understand the following safety, operations, and maintenance instructions can result in serious injuries and/or death. All operators must be properly trained or supervised prior to using these saws and should understand the risks and hazards involved. Improper or unintended saw usage is discouraged and Diamond Products cannot be held liable for any damages.

All saw modifications should be made by Diamond Products to ensure proper safety and accuracy. Modifications made to these saws by the owner are not the responsibility of Diamond Products and void all saw warranties if a problem arises from the modification.

Refer to the Diamond Products' Parts List for additional information and part diagrams. Refer to the engine/motor manual and manufacturer as the primary source for all safety, operations, and maintenance instructions for the engine/motor. Prior to operating the saw, record the saw's serial number, and the engine's model and serial numbers in the Serial Tags section in the Index.

The information in this manual may be updated at any time.

Safety Alerts

DANGER

Serious injuries and/or death will occur if these instructions are not followed.

WARNING

Serious injuries and/or death could occur if these instructions are not followed.

CAUTION

Mild and/or moderate injuries could occur if these instructions are not followed.

Proposition 65

WARNING

Engine exhaust and some of its constituents are known to the State of California to cause cancer, birth defects, and/or other reproductive harm.



Spark Arrester Requirement

WARNING

In the State of California it is a violation of Section 4442 or 4443 to use or operate the engine on any forest-covered, brush-covered, or grass-covered land unless the engine is equipped with a spark arrester, as defined in Section 4442, maintained in effective, working order or the engine is constructed, equipped, and maintained for the prevention of fire pursuant to Section 4443.

Respiratory Hazards

WARNING

Concrete cutting produces dust and fumes known to cause illness, death, cancer, respiratory disease, birth defects, and/or other reproductive harm. Safety protection techniques include, but are not limited to:

- Wearing gloves.
- Wearing safety goggles or a face shield.
- Using approved respirators.
- Washing work clothes daily.
- Using water when wet cutting to minimize dust.
- Washing the hands and face prior to eating/drinking.

For additional safety and self-protection information contact your employer, the Occupational Safety and Health Administration (OSHA), and/or The National Institute for Occupational Safety and Health (NIOSH).

General Safety

- Read and understand all of the safety, operations, and maintenance instructions in this manual prior to operating or performing maintenance on the saw.
 - Clean slurry, concrete dust, and debris from the saw daily/regularly.
 - Raise the saw to a proper height for easy access when working underneath the saw, and place jack stands or blocks under the frame edges at the front and back of the frame.
- 
- Repair the saw immediately if a problem arises.
 - Replace saw decals when they become unreadable.
 - Dispose of all hazardous waste materials properly and according to city, state, and federal regulations.
 - Always have a phone available, and identify the location of the nearest fire extinguisher and first aid kit prior to operating the saw.
 - Persons under the statutory age limit should not operate the saw.
 - Let the saw cool down after operating it to prevent serious burns.
 - Properly chock the tires when parking the saw on a slope to prevent unnecessary movement.
 - All non-routine maintenance tasks should be performed by an authorized service center.

DO NOT:

- Operate the saw without using the appropriate safety equipment required for the work task.



- Operate or maintenance the saw with clothing, hair, or accessories that can snag in the machinery.
- Operate the saw wearing flammable clothing.
- Operate the saw using attachments not associated with or recommended for the saw.
- Operate the saw with anyone near the work area.
- Operate the saw until all unnecessary materials have been removed from the work area.
- Operate the saw with loose nuts and bolts.

DO NOT (cont.):

- Operate the saw when feeling ill or fatigued
- Operate the saw under the influence of drugs and/or alcohol.
- Operate the saw on extremely steep slopes.
- Operate the saw with guards and access panels removed.
- Grease/lubricate the saw with the engine/motor running unless stated otherwise.
- Perform maintenance until the saw cools down.
- Perform maintenance with the engine/motor running unless stated otherwise.

Blade Safety

- Always use reinforced abrasive blades or steel-centered diamond blades.
 - Inspect all blades prior to using and discard damaged blades.
 - DO NOT install a blade with the engine/motor running.
-
- DO NOT expose yourself or anyone else to the direct line of the blade when operating the saw.
- 
- Keep all body parts away from rotating blades.
 - Inspect the blade flanges for damages, wear, and cleanliness. Clean, repair, or replace damaged components immediately.
 - Always use an appropriate size blade for the cutting task. The blade must fit snug on the blade shaft.
 - The outer flange must fit snug on the blade shaft, through the blade, and into the inner flange alignment pinhole.
 - Wear gloves and be alert to the surrounding environment when handling blades.
 - DO NOT drop the blade.
 - Always point the arrow printed on the blade in the direction of the blade shaft's rotation when installing the blade.
 - Always use the correct blade type for the material being cut.
 - DO NOT exceed the blade's maximum recommended speed when cutting. Excessive blade speeds can cause blade breakage, resulting in serious injuries and/or death.
 - DO NOT use damaged blades when cutting to avoid harming yourself, others, or the saw.

- DO NOT use a blade for cutting that is rated with a lower maximum operating speed than the blade shaft speed.
- Tighten the blade shaft nut/screw to 50 foot-pounds (ft-lb) (67.8 Newton-meters (Nm)) to properly secure the outer flange and blade. Failure to properly secure the outer flange and blade may cause parts to loosen or fall off of the saw when operating it.
- Raise the blade when maneuvering the saw to provide proper clearance between the blade and the ground.
- Let the blade cool prior to removing or replacing blades when dry cutting.



Blade Guard Safety

- DO NOT operate the saw with the blade guard raised or removed.
- Blade exposure should not exceed 180° when cutting.
- Always pivot the front of the blade guard 180° (fully upward) so the guard does not swing back unexpectedly, which may cause serious injuries.
- DO NOT remove the blade guard with the engine/motor running.
- Always use a blade guard that corresponds with the blade size.
- Inspect the blade guard and its water tubes prior to starting the saw. Clean, repair, or replace damaged components immediately.



Fuel Safety

- Store fuel in an appropriate safety container.
- DO NOT operate the saw with a fuel leak.
- DO NOT fuel the saw with the engine running.
- Let the engine cool prior to adding fuel.
- DO NOT smoke or expose fuel to open flames when filling the fuel tank or working with fuel.
- Refer to the engine manual for recommended fuels.
- Clean up spilled fuel prior to starting the engine.
- Fuel may seep out from the fuel cap vent (applicable models) when the saw is raised.



- Move the saw away from the fueling area prior to starting the engine.
- Drain the fuel tank and fuel lines for longer storage periods. Refer to the engine manual for additional information.

Engine/Motor Safety

- Refer to the engine/motor manual as the primary source for engine/motor safety and general care practices.
- Occasionally measure the engine speed and adjust the engine governor, as necessary, to the factory setting for proper saw and blade efficiency.
- Always know how to turn off the engine/motor for emergency purposes.
- Fill the fuel tank and check the oil level prior to starting the engine.
- DO NOT leave the engine/motor running unattended.
- Keep all body parts away from rotating saw parts with the engine/motor running.
- DO NOT start the engine without the air filter(s) installed.
- DO NOT allow dust to enter the air intake tube when cleaning/replacing the air filter(s) to prevent serious engine damage.
- Immediately replace damaged saw components that may allow dust to enter the engine.
- Always operate the saw in well-ventilated areas. Concentrated engine exhaust can cause loss of consciousness and/or death.
- DO NOT operate the saw around combustible materials or fumes to prevent fires/explosions.
- DO NOT leave the saw unattended until the engine/motor is off and the blade has stopped spinning.
- Wipe down the engine/motor exterior and guards daily or regularly to prevent high operating temperatures. DO NOT spray the engine/motor with water to prevent engine damage.
- DO NOT touch the engine/muffler assembly with the engine running, and always let the parts cool down after operating the saw to prevent serious burns.



- Let the engine/motor cool prior to performing maintenance.
- Handle hot oil carefully when changing the engine oil.
- DO NOT perform maintenance with the engine/motor running unless stated otherwise.

- For water cooled engines, let the engine cool prior to removing pressurized caps.



- Disconnect the electric motor saw from the power source prior to touching electrical connections.
- Disconnect the electric motor saw from the power source prior to performing maintenance.
- All electric motor saws should be properly grounded prior to operating.
- DO NOT supply less or more power to the electric motor than what the motor is rated for.

Cutting Safety

- The work area should not contain buried or embedded electrical, gas, or water lines.
- Turn off all electricity, gas, and water around the work area prior to cutting.
- When using an electric motor saw, be aware of all electrical lines around the work area when power is necessary.

- DO NOT expose yourself or anyone else to the direct line of the blade when cutting.



- DO NOT allow any person, animal, or object in and around the work area when cutting.
- Use just enough handle pressure to guide the saw on the cutting line. DO NOT forcibly direct (twist) the saw from side-to-side to avoid damaging the saw and blade.
- Avoid sawing excessively deep to preserve the blade and reduce sawing costs.

Belt Safety

- Turn off the engine/motor prior to performing belt maintenance.
- Let the belts cool down prior to performing belt maintenance.
- Regularly inspect the belts for fraying, stress cracks, and/or breakage and replace immediately if there are damages.

- Over-tensioning the belts may damage the engine crankshaft. Under-tensioning the belts may cause shorter belt life and/or poor saw performance.
- Squealing belts indicate looseness.
- Make sure the belts are properly aligned prior to operating the saw.
- Always replace the belt guard prior to operating the saw.

Transporting Safety

- Remove the blade prior to transporting the saw.
- Move the fuel shutoff lever to the closed or off position to prevent fuel leaks when transporting the saw.
- Drain the fuel tank when transporting the saw long distances.
- Use heavy-duty ramps that will properly support the weight of the saw and yourself when loading/unloading.
- The towing truck/trailer should be in good, working condition.
- Raise the saw to avoid damaging saw components while moving up and down ramps.
- Use extreme caution when guiding the saw up and down ramps. Slowly push the saw forward to guide it down the ramp. Slowly pull the saw backward to guide it up the ramp.
- Turn off the engine/motor once the saw is loaded into the truck/trailer.
- Properly block and chain the saw in the truck/trailer prior to transporting.
- Refer to the Department of Transportation (DOT) for additional information regarding proper transportation techniques and truck/trailer requirements.

Lifting Safety

- Move yourself and all others away from the lifting area when hoisting the saw to prevent being crushed underneath the saw.



- Secure the appropriate hoisting cables, straps, ropes, wires, and/or chains to the lift points on the frame to properly lift the saw when hoisting.
- DO NOT attempt to lift the saw irresponsibly and/or improperly.

Introducing the CC1200 and CC1300XL

CC1200 Components

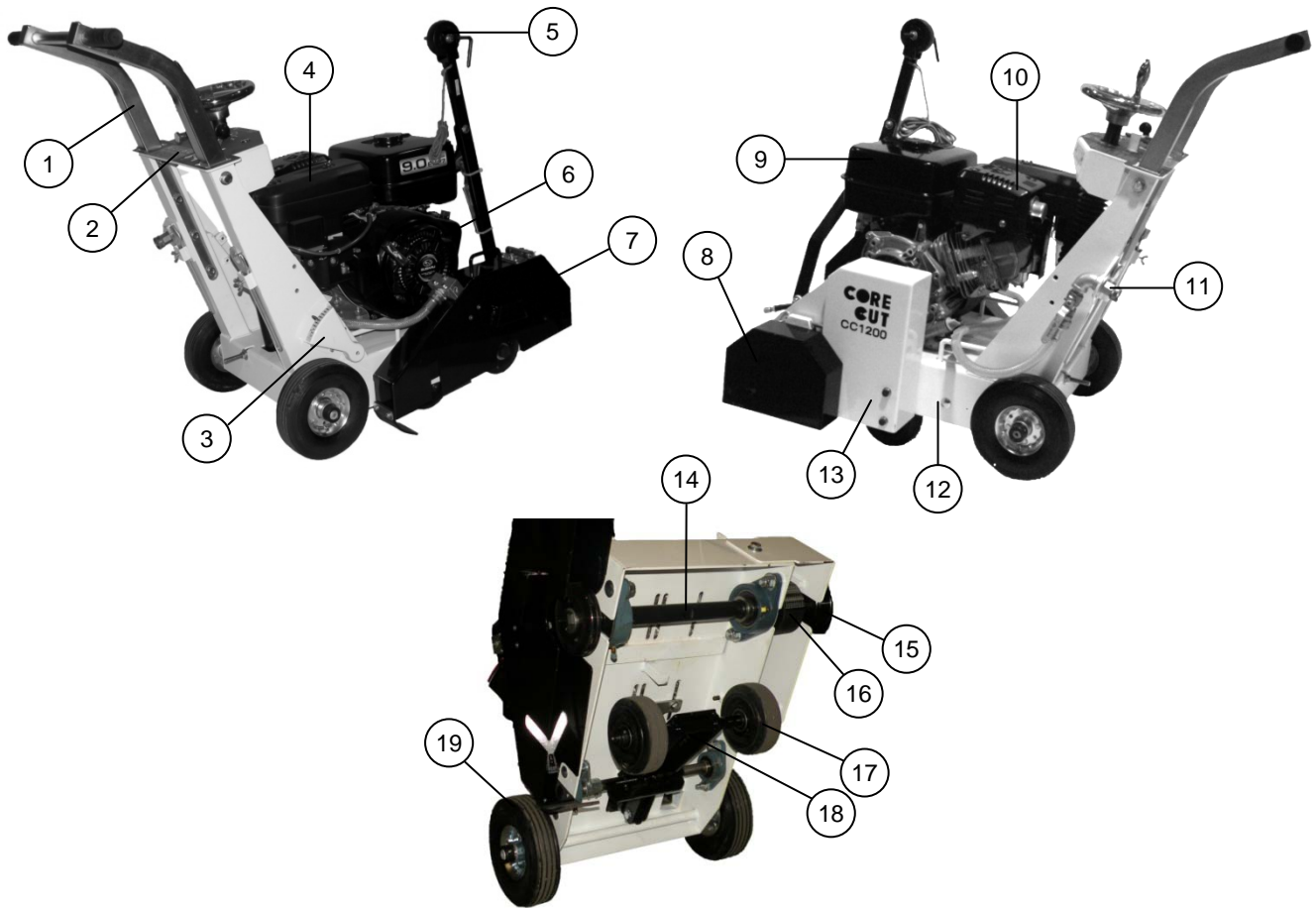

Figure 1: CC1200 Components

1. Handlebars
2. Instrument Panel
3. Depth Indicator
4. Air Cleaner
5. Front Pointer
6. Engine
7. Blade Guard
8. Flange Guard
9. Fuel Tank
10. Muffler

11. Water Supply
12. Frame
13. Belt Guard
14. Blade Shaft
15. Blade Flange
16. Belt Drive
17. Front Wheels
18. Front Axle
19. Rear Wheels

CC1300XL Components

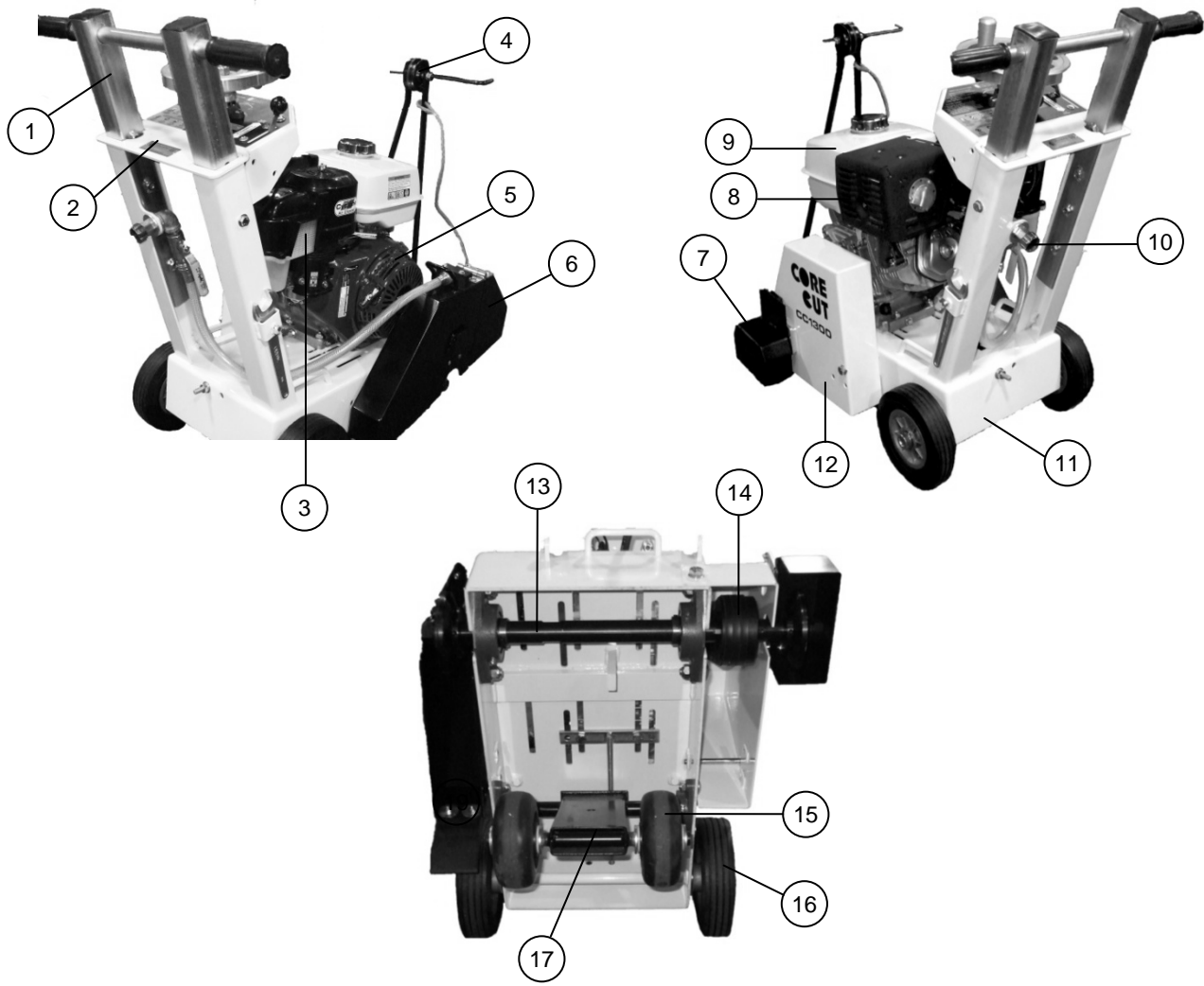

Figure 2: CC1300XL Components

1. Handlebars
2. Instrument Panel
3. Air Cleaner
4. Front Pointer
5. Engine
6. Blade Guard
7. Flange Guard
8. Muffler
9. Fuel Tank

10. Water Supply
11. Frame
12. Belt Guard
13. Blade Shaft
14. Belt Drive
15. Front Wheels
16. Rear Wheels
17. Front Axle

Controls

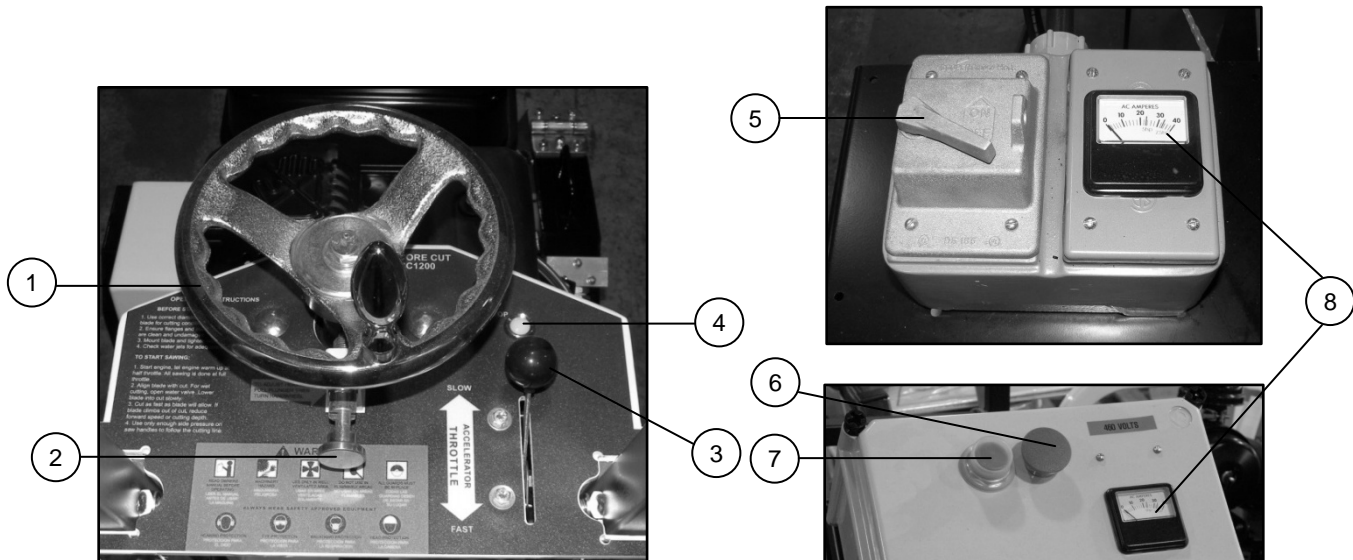

Figure 3: Control Panel

Figure 4: Electric Motor Starter Boxes

Controls Shown Above:

1. **Handwheel**—Raises/lowers saw and blade.
2. **Index Plunger**—Locks/unlocks handwheel.
3. **Throttle Lever**—Increases/decreases engine speed.
4. **Stop Pushbutton**—Stops engine (engine switch must be off to stop engine permanently).
5. **On/Off Lever**—Starts/stops electric motor.
6. **Stop Pushbutton**—Stops electric motor.
7. **Start Pushbutton**—Starts electric motor.
8. **Ammeter**—Indicates electric motor's load while cutting.

Controls not Shown Above:

1. **Water Valve**—Controls water flow to blade.
2. **Engine/Stop Switch**—Actuate in order to start/stop engine.
3. **Recoil Starter**—Starts engine.
4. **Choke**—Restricts air flow in carburetor when starting cold engine.
5. **Fuel Tank Cap**—Opening to add fuel.
6. **Fuel Shutoff Lever**—Opens/closes fuel line.

Note: Each control applies to certain saw models.

CC1200 Dimensions

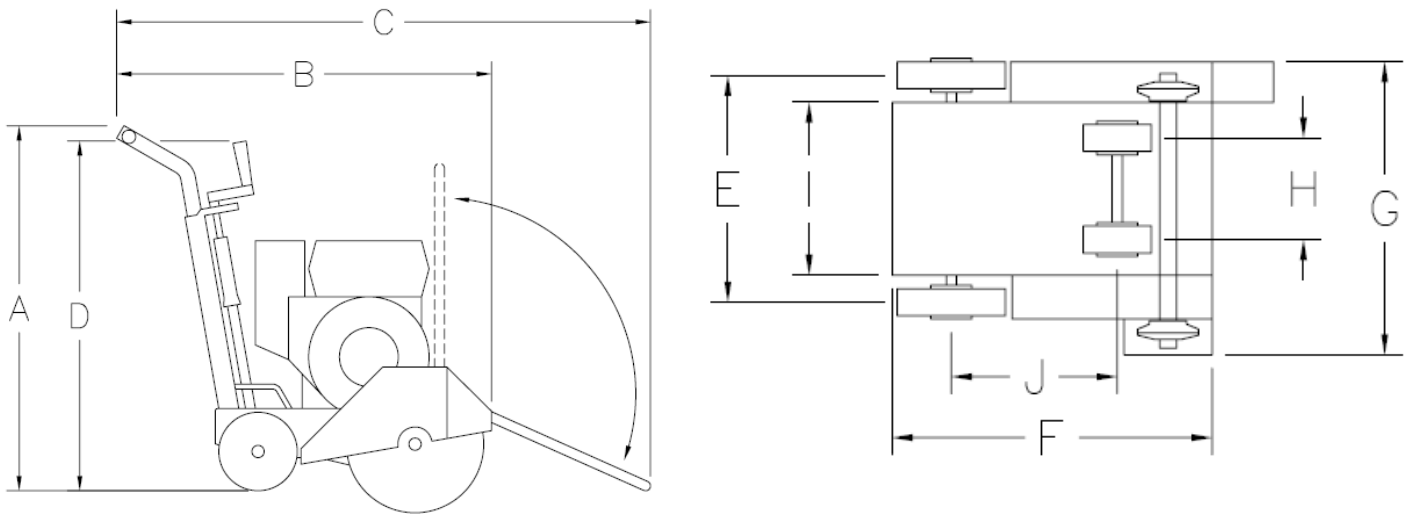

Figure 5: CC1200 Dimensions

Table 1: CC1200 Dimensions		
A	Saw Height (Minimum/Maximum)	36"/46"
B	Saw Length (Minimum, Pointer Up, Handles Down)	39"
C	Saw Length (Maximum, Pointer Down, Handles Up)	60"
D	Saw Height to Hand Wheel	32"
E	Frame Width Rear	17"
F	Frame Length	26"
G	Frame Width Front	23"
H	Front Axle Center Length	9-1/2"
I	Rear Axle Center Length	13-3/4"
J	Wheel Base Length	13"
	Crated Dimensions	34" x 26" x 39"

CC1300XL Dimensions

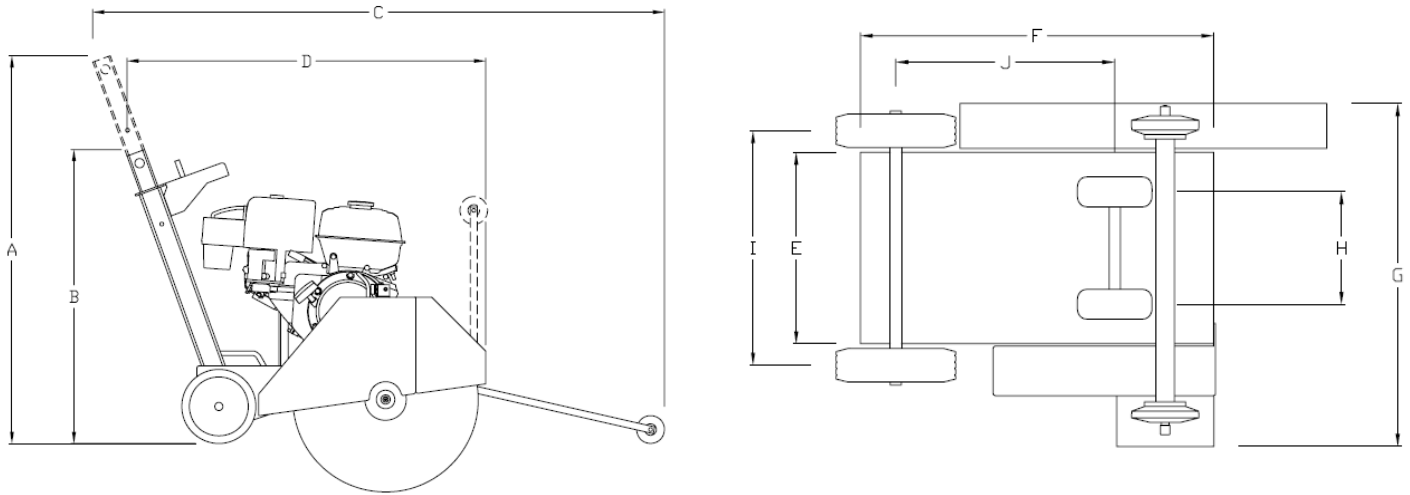

Figure 6: CC1300XL Dimensions

Table 2: CC1300XL Dimensions		
A	Saw Height (Maximum, Handle Up)	41-3/8"
B	Saw Height (Minimum, Handle Down)	35-1/4"
C	Saw Length (Maximum, Handles Up, Pointer Down)	61-1/4"
D	Saw Length (Minimum, Handles Down, Pointer Up)	38-1/2"
E	Frame Width	12-3/4"
F	Frame Length	23-5/8"
G	Saw Width	22-5/8"
H	Front Axle Center Length	7-1/2"
I	Rear Axle Center Length	15-1/2"
J	Wheel Base Length	13"
	Crated Dimensions	54" x 30" x 48"

Specifications

Table 3: CC1200 Specifications	
Maximum Cutting Depth with 14" Blade	4-5/8"
Maximum Cutting Depth with 18" Blade	6-5/8"
Blade Shaft RPM	2,600
Blade Shaft Diameter	1-1/4"
Arbor Diameter	1" with single alignment pin
Blade Shaft Bearings	Self-aligning pillow block bearings
Blade Shaft Drive	One 280J V-ribbed belt
Blade Mounting	Right or left
Blade Raise/Lower	Screw feed
Blade Coolant	Dual multi-spray water tubes
Blade Guard Attachment	Slip-on
Handlebars	Three-position
Drive System	Push model
Fuel Capacity	1.75 gallons
Quick Disconnect Blade Flanges	Standard
Uncrated Weight	205-210 lb (add 40 lb for crated weight)

Table 4: CC1300XL Specifications	
Maximum Cutting Depth with 14" Blade	4-5/8"
Maximum Cutting Depth with 18" Blade	6-5/8"
Maximum Cutting Depth with 20" Blade	7-5/8"
Blade Shaft RPM	2,600
Blade Shaft Diameter	1-1/4"
Arbor Diameter	1" with single alignment pin
Blade Shaft Bearings	Self-aligning pillow block bearings
Blade Shaft Drive	Three or four 3VX V-belts
Blade Mounting	Right or left
Blade Raise/Lower	Screw feed
Blade Coolant	Dual multi-spray water tubes
Blade Guard Attachment	Slip-on
Handlebars	Three-position
Drive System	Push model
Fuel Capacity	1.75 gallons
Quick Disconnect Blade Flanges	Standard
Uncrated Weight	210-250 lb (add 40 lb for crated weight)

Table 5: Engine Specifications			
Manufacturer	Robin-Subaru	Honda	Honda
Model	EX27D	GX270	GX390
Fuel Type	Unleaded gasoline	Unleaded gasoline	Unleaded gasoline
Air Filter	Dual element	Cyclone, dual element	Cyclone, dual element
Low Oil Alert	Standard	Standard	Standard
<i>Note: Refer to the engine manual for additional information.</i>			

Table 6: Electric Motor Specifications	
Manufacturer	Baldor Electric
Phase/Voltage	1PH-230V, 3PH-230V, 3PH-460V, 3PH-575V
<i>Note: Refer to the motor manual for additional information.</i>	

Operating the CC1200 and CC1300XL

Handlebars

The handlebars help the operator guide and maneuver the saw.

Adjusting the Handlebars

1. Remove the screws securing the handlebars to the frame.
2. Holding the handlebar grips, move the handlebars up or down (matching the holes on the handlebar shaft to the holes on the frame) to adjust the handlebars to the desired height.
3. Secure the handlebars to the frame.



Figure 7: CC1200 Handlebars



Figure 8: CC1300XL Handlebars

4. Adjust the handlebar height as necessary.

Front Pointer

The front pointer helps the operator follow the cutting line.

Adjusting the Front Pointer

1. Remove the looped end of the shorter pointer rope line from the handlebar grip.
2. Lower the front pointer frame to the ground.
3. Divide an 8–10 ft piece of string in half.
4. Place the looped end of string into a gullet on the backside of the blade.
5. Place one string line up against the backside of the blade and one string line up against the front side of the blade. Holding the string ends in one hand, tension the lines out toward the pointer rod.

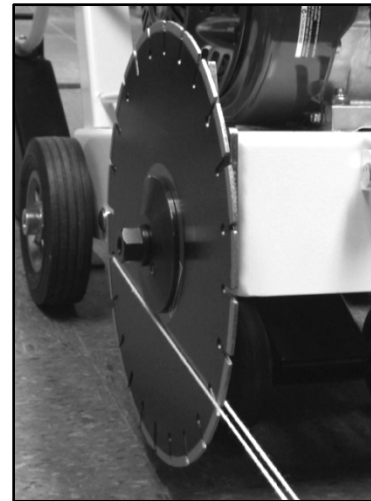

Figure 9: String Line and Blade

6. Loosen the nuts securing the pointer rod.
7. Adjust the pointer rod to place the pointer tip in between the tensioned string lines.
8. Retighten the nuts to secure the pointer rod.
9. Lift the front pointer frame off the ground when the cutting task is complete.
10. Place the looped end of the rope line around the handlebar grip.

Diamond Blades

WARNING

- DO NOT exceed the blade's maximum recommended speed when cutting. Excessive blade speeds can cause blade breakage, resulting in serious injuries and/or death.
- DO NOT use damaged blades when cutting to avoid harming yourself, others, or the saw.
- Always use the correct blade type for the material being cut.



Using the proper blade (size and type) preserves the blade and improves cutting and operator efficiency, resulting in lower costs. Refer to the Association of Equipment Manufacturers (AEM) safety brochure for diamond blades or www.diamondproducts.com for additional blade information.

Inspecting the Blade

Inspect each blade prior to installation and discard all damaged blades. Inspect all blades for:

- Cracks, nicks, and dents
- A damaged and/or deformed arbor (center hole)
- Darkness and/or discoloration near edge of blade
- A deformed blade circumference
- Segment loss and/or segment cracks
- Core wear
- Bending
- Uneven side-widths

Blade Speed

Refer to the blade packaging information or to the information printed on the blade for the recommended and maximum recommended blade speeds when cutting. DO NOT exceed the maximum recommended cutting speed. DO NOT use a blade that is rated with a lower maximum recommended speed than the blade shaft speed.

Wrench

Use the wrench when installing or removing a blade. Apply force to the opposite end of the wrench and tighten the blade shaft nut/screw to 50 ft-lb (67.8 Nm) to properly secure the outer flange and blade. This measurement can be verified with a torque wrench.

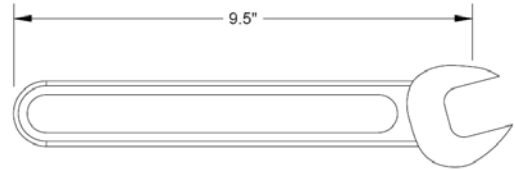

Figure 10: Wrench

Installing the Blade

WARNING

- DO NOT install a blade with the engine running.
- Failure to properly secure the outer flange and blade may cause parts to loosen or fall off of the saw.



CAUTION

- Wear gloves and be alert to the surrounding environment when handling blades.

Install the blade on either the right or left side of the saw; utilize the side most appropriate for the cutting task.

1. Remove the blade guard or pivot the front of the guard 180° (fully upward) to gain access to the blade flanges. *Note: Failure to fully pivot the guard may cause serious injuries.*
2. Remove the blade shaft nut/screw using the wrench. Turn the nut/screw clockwise on the right side of the saw and counterclockwise on the left side of the saw to loosen.
3. Carefully pull the outer flange off of the blade shaft and out of the inner flange alignment pinhole.



Figure 11: Separating the Flanges

4. Inspect the nut/screw, outer flange, and inner flange for damages and clean, repair, or replace as necessary.
5. Select the correct blade type and size for the cutting task and inspect the blade for damages. DO NOT use blades that are too small/large for the saw.
6. Raise the saw slightly (for easier access when installing the blade).
7. Place the blade onto the blade shaft (the blade should fit snug on the blade shaft). Always point the arrow printed on the blade in the direction of the blade shaft's rotation.
8. Place the outer flange onto the blade shaft, and align and fit the outer flange alignment pin through the blade's pinhole and into the inner flange alignment pinhole.

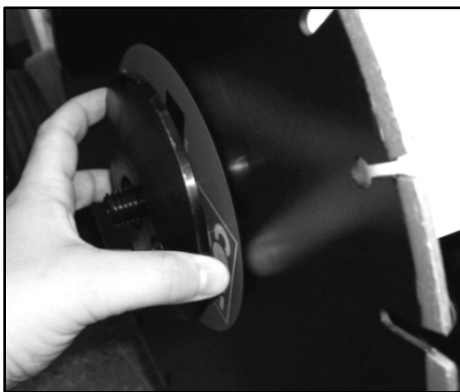

Figure 12: Inserting the Outer Flange

9. Slightly rotate the outer flange and blade backward to eliminate backlash (looseness) between parts.
10. Fit the blade shaft screw into the threads in the blade shaft (CC1200). Fit the blade shaft nut onto the threads on the blade shaft (CC1300XL).
11. Tighten the nut/screw by hand. Slowly lower the blade until it touches the ground.

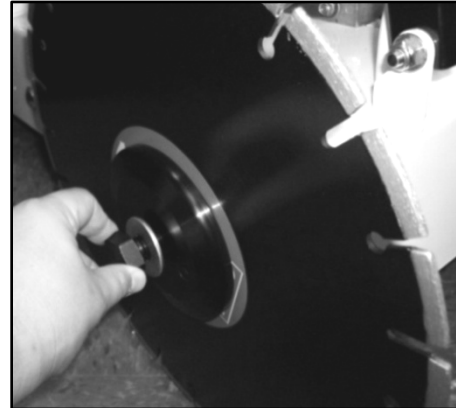

Figure 13: Tightening the Nut

12. Tighten the nut/screw, using the wrench, to 50 ft-lb (67.8 Nm) to secure the outer flange and blade. This measurement can be verified with a torque wrench.
13. Replace the blade guard or pivot the front of the guard down and over the blade to secure.

Removing the Blade

CAUTION

- Let the blade cool prior to removing or replacing blades when dry cutting.



1. Remove the blade guard or pivot the front of the guard 180° (fully upward) to gain access to the blade flanges. *Note: Failure to fully pivot the guard may cause serious injuries.*
2. Slowly lower the blade until it touches the ground.
3. Remove the blade shaft nut/screw using the wrench.

4. Carefully remove the outer flange from the inner flange alignment pinhole and blade, and then remove the flange from the blade shaft.
5. Remove the blade from the blade shaft. Place the blade in an appropriate storage location.
6. Inspect the nut/screw, outer flange, and inner flange for damages and clean, repair, or replace as necessary.
7. Fit the outer flange back onto the blade shaft.
8. Fit the blade shaft screw into the threads in the blade shaft (CC1200). Fit the blade shaft nut onto the threads on the blade shaft (CC1300XL). Tighten the nut/screw by hand to secure the inner and outer flange together.
9. Replace the blade guard or pivot the front of the guard down and over the blade to secure.

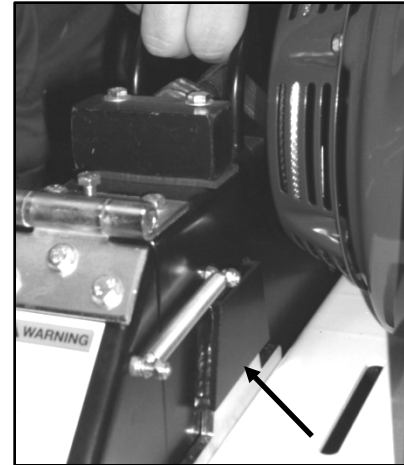

Figure 14: Lowering the Guard

Blade Guard

! WARNING

- DO NOT operate the saw with the blade guard raised or removed.
- DO NOT remove the blade guard with the engine running.
- Blade exposure should not exceed 180° while cutting.
- Always pivot the front of the blade guard 180° (fully upward) so the guard does not swing back unexpectedly, which may cause serious injuries.



The blade guard shields the blade and must always be in place when operating the saw. Inspect the blade guard and its water tubes prior to starting the saw. Clean, repair, or replace damaged components immediately. *Note: Always use a blade guard that corresponds with the blade size.*

Installing the Blade Guard

1. Face the front of the blade guard forward and fit the tapered mount on the side of the guard over the tapered blade guard mount on the frame.

2. Insert the lock pin through the matched up holes on the blade guard and the tapered blade guard mount to secure the guard (CC1200).
3. Connect the water supply hose to the blade guard.

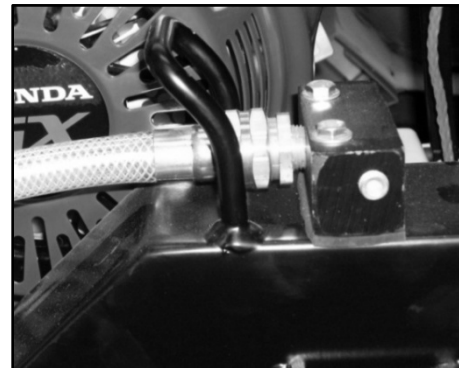

Figure 15: Connecting the Hose

Removing the Blade Guard

1. Disconnect the water supply hose from the blade guard.
2. Remove the lock pin from the blade guard (CC1200).
3. Use the handle on the blade guard to rock the guard back and forth while lifting the guard off of the tapered mount.

Flange Guard

Installing the Flange Guard

1. Fit the tapered mount on the backside of the flange guard over the tapered blade guard mount on either the belt guard (left side of saw) or the frame (right side of saw).
2. Insert the lock pin through the hole on the tapered blade guard mount to secure (CC1200).

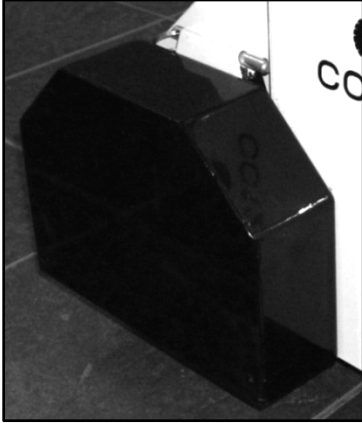

Figure 16: CC1200 Flange Guard

Removing the Flange Guard

1. Remove the lock pin from the flange guard (CC1200).
2. Lift the guard off of the tapered blade guard mount.

Water System

The water system cools the blade and minimizes dust when cutting. *Note: Always test the water supply for adequate pressure and flow prior to cutting.*

Water Valve and Supply Hose(s)

1. Connect the water source hose to the water supply fitting.



Figure 17: Water Supply Fitting

2. Connect the water supply hose to the blade guard. *Note: Disconnect and reconnect the hose when moving the blade guard to the opposite side of the saw.*
3. Turn on the water valve to start the water flow and turn off the water valve to stop the water flow. The water flow between these two points increases/decreases based on the valve's position. *Note: Turn on the water just before cutting to avoid wasting water.*

Water Tank

The water tank (optional item) decreases airborne dust when wet cutting. *Note: The water tank cannot be used with the electric motor saw.*

- Connect the water tank's water supply hose to the blade guard prior to operating the saw.

Handwheel

The handwheel raises and lowers the saw and blade. *Note: The saw can be raised and lowered with the engine off.*



Figure 18: CC1300XL Handwheel

! CAUTION

- Clean up spilled fuel prior to starting the engine.
- Fuel may seep out from the fuel cap vent (applicable models) when the saw is raised.

Fueling the Saw

Fill the fuel tank as necessary.

1. Lower the saw so the engine is level.
2. Stop the engine and let the saw cool down.
3. Remove the fuel tank cap.

Raising the Saw

1. Pull out the index plunger and turn it 90° to remove from the plunger groove. Turn the handwheel clockwise (CC1200) or counterclockwise (CC1300XL) to raise the saw.
2. Turn the index plunger 90° to lock it back into the plunger groove. Turn the handwheel slightly to lock the handwheel.

Lowering the Saw

1. Pull out the index plunger and turn it 90° to remove from the plunger groove. Turn the handwheel counterclockwise (CC1200) or clockwise (CC1300XL) to lower the saw.
2. Turn the index plunger 90° to lock it back into the plunger groove. Turn the handwheel slightly to lock the handwheel.

Fuel System (Gas Models)

! WARNING

- DO NOT operate the saw with a fuel leak.
- DO NOT fuel the saw with the engine running.
- DO NOT smoke or expose fuel to open flames when filling the fuel tank or working with fuel.



Figure 19: Fuel Tank and Cap

4. Fill the fuel tank with unleaded gasoline. Refer to the engine manual for refueling information.
5. Replace the fuel tank cap and tighten to secure.

Storage

Refer to the engine manual for fuel recommendations when storing the saw.

Engine/Motor

Refer to the engine/motor manual as the primary source for information.

! WARNING

- DO NOT expose yourself or anyone else to the direct line of the blade when operating the saw.
- DO NOT leave the engine/motor running unattended.
- Operate the saw in well-ventilated areas. Concentrated engine exhaust can cause loss of consciousness and/or death.
- All electric motor saws should be properly grounded prior to operating.



Tasks Prior to Starting the Engine/Motor

Make sure to complete the following tasks prior to starting the engine/motor:

- Fill all liquids to appropriate levels for proper saw operation.
- Set engine throttle to slowest position (gas saw).
- Remove tools from work area.
- Raise blade off ground.

Starting the Engine/Motor

Gasoline Engine

1. Move the fuel shutoff lever to the open or on position.
2. Close the choke. *Note: When restarting a warm engine, open the choke.*
3. Increase the throttle by approximately 1/3.
4. Turn on the engine switch/stop switch.
5. Pull the recoil starter handle backward slowly until resistance is felt, and then pull the handle backward quickly. Gently return the handle and repeat if the engine does not start. *Note: Refer to the engine manual if the engine does not start after several attempts.*

Engine Governor (Gas Models)

The engine governor (located at the top of the engine) is factory set for an engine speed of 3,600 RPM. DO NOT change this setting to prevent engine damage. Occasionally measure the engine speed and adjust to the factory setting, as necessary, following the steps below:

1. Use a handheld tachometer or other appropriate device to measure the engine speed at the engine crankshaft.
2. Adjust the engine governor to correct the engine speed.

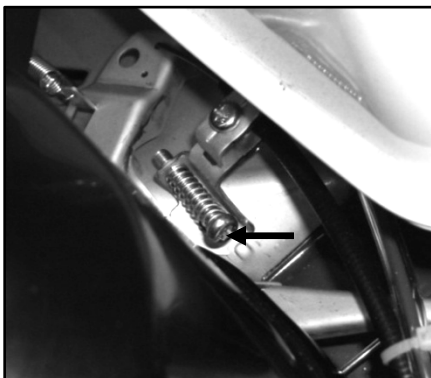

Figure 20: Engine Governor



Figure 21: Recoil Starter

6. Decrease the throttle to the slowest position. Gradually open the choke while the engine warms up.
7. Increase the throttle to the fastest position and adjust the throttle as necessary for maximum efficiency. DO NOT exceed the maximum recommended cutting speed when operating the saw.

Electric Motor (CC1300XL)

1. Plug the saw into an outlet or generator. Refer to Diamond Products for a list of recommended power cord gauges. *Note: DO NOT supply less power or more power, through the power source, to the motor than what the motor is rated for.*
2. Turn on the power lever (5 HP–1PH or 5 HP–3PH), or press the start button (10 HP–3PH) to start the motor.

Stopping the Engine/Motor

CAUTION

- DO NOT leave the saw unattended until the engine/motor is off and the blade has stopped spinning.

Gasoline Engine

1. Decrease the throttle to the slowest position for several minutes.
2. Hold down the stop button (on the control panel) to stop the engine (applicable models). *Note: This action does not permanently stop the engine.*
3. Turn off the engine switch/stop switch. *Note: Turning off the switch will stop the engine permanently and will prevent the blade from spinning unexpectedly.*
4. Pull the recoil starter handle backward slowly until resistance is felt and gently return the handle (applicable models).

Electric Motor (CC1300XL)

1. Turn off the power lever (5 HP–1PH or 5 HP–3PH), or press the stop button (10 HP–3PH) to stop the motor.
2. Disconnect the power cord from the saw and from the outlet or generator.

Concrete Cutting

WARNING

- DO NOT expose yourself or anyone else to the direct line of the blade when cutting.
- Turn off all electricity, gas, and water around the work area prior to cutting.
- When using an electric motor saw, be aware of all electrical lines in the area when power is necessary.



Helpful Hints Prior to Cutting

Keep the following in mind for greater efficiency when cutting:

- Use just enough handle pressure to guide saw on the cutting line. DO NOT forcibly direct (twist) saw from side-to-side when cutting.
- Avoid sawing excessively deep to preserve the blade and reduce sawing costs.
- Moving too quickly when cutting may stall the saw or may cause the blade to climb out from the cut. If the saw stalls at any time, raise blade from the cut and restart engine.
- DO NOT lower the blade too quickly or push the saw forward too quickly when finishing a partial-cut to avoid forcing the blade into the concrete.

Tasks Prior to Cutting

Complete the following tasks prior to cutting:

- Raise the blade to provide proper clearance between the blade and the ground when maneuvering saw.
- Align pointer assembly with the blade.
- Clearly mark the cutting line.
- Be sure the work area does not contain any buried or embedded electrical, gas, or water lines.

Making a Cut

1. Turn on the water valve. *Note: Always have a proper water pressure and flow when cutting.*
2. Align the blade and front pointer with the cutting line.
3. Lower the blade into the concrete slowly. DO NOT cut any deeper than required. Use the depth indicator (CC1200) as a reference to determine the blade's depth when cutting.
4. Push the saw forward, at a proper speed, to continue down the cutting line. Cut as fast as the blade allows; if the blade climbs out of the cut reduce the forward speed and/or cutting depth. Raise and lower the blade as necessary while cutting.

Continuing a Partial-Cut

1. Align the blade with the previous cut and lower the blade back into the cut (using the depth indicator (CC1200) as necessary). DO NOT move forward unless the blade is properly aligned within the cut.
2. Push the saw forward, at a proper speed, to continue down the cutting line. Raise and lower the blade as necessary while cutting.

Finishing a Cut

1. Stop the saw.
2. Raise the blade from the cut (high enough for proper ground clearance).
3. Turn off the water valve.

Maintaining the CC1200 and CC1300XL

Failure to read and comply with the maintenance instructions provided in this manual may result in serious injuries and/or death, and may harm the saw. DO NOT attempt to perform maintenance on these saws if you are not properly trained for it, or are not supervised by an experienced person.

Refer to the Diamond Products' Parts List for additional information and part diagrams when performing maintenance tasks. Refer to the engine/motor manual and manufacturer as the primary source for all safety, operations, and maintenance instructions for the engine/motor. All non-routine maintenance tasks should be performed by an authorized service center. Contact the manufacturer with any additional questions.

Tasks Prior to Maintenance

Complete the tasks listed below prior to performing saw maintenance:

- Turn off engine and let saw cool down.
- Turn off switches and controls.
- Remove guards and access panels for easy access.
- Disconnect electric motor saw from power source (electric saw).
- Move fuel shutoff lever to closed or off position (gas saw).
- Raise saw to proper height for easy access when working underneath saw, and place jack stands or blocks under frame edges at front and back of frame.

Maintenance Overview

Complete the following maintenance tasks as required. DO NOT delay maintenance! Print the Daily Maintenance Task Chart from the Index to keep track of the maintenance tasks completed.

Daily/Regularly

- Lubricate blade shaft bearing grease fittings daily, or two to three times daily when dry cutting.



- Inspect belts after first four hours of use, and then daily for tension and wear. Replace or re-tension as necessary.
- Inspect saw for damages.
- Tighten loose nuts and bolts.
- Clean air filter daily, or two to three times daily when dry cutting (see engine manual).
- Check fuel level and fill as necessary.
- Check engine oil level and fill as necessary (see engine manual).
- Wipe down saw's exterior.
- Wipe down engine/motor exterior and guards.
- Look for fluid leaks.

Note: Refer to the engine/motor manual and manufacturer for a full maintenance schedule and additional maintenance information.

Handlebars

The handlebars generally require little or no maintenance and, when used correctly, should remain in good, working condition. Inspect the handlebars occasionally for bending, unusual cracks, and/or breakage. Replace them immediately when damaged.

Part Lubrication

 WARNING <ul style="list-style-type: none">• DO NOT grease parts with the engine running unless stated otherwise.	
---	---

Lubricating parts on schedule increases the saw's efficiency and life. Use NLGI No. 2 premium lithium-based grease when lubricating parts.

Blade Shaft

Lubricate both blade shaft bearing grease fittings at the end of the workday, or two to three times daily when dry cutting. Always grease the fittings with the engine/motor running at idle (extremely low speed!). Use one full pump of grease when greasing the blade shaft fittings.

Axle

Lubricate both flange block bearing grease fittings every 40 hours of operation.

Adjustment Shaft

Lubricate the adjustment shaft grease fitting every 100 hours of operation. Lubricate the adjustment shaft flange block bearing grease fitting every 100 hours of operation.

Inner Blade Flange

The inner blade flange may be taken off of the blade shaft to clean/replace the part.

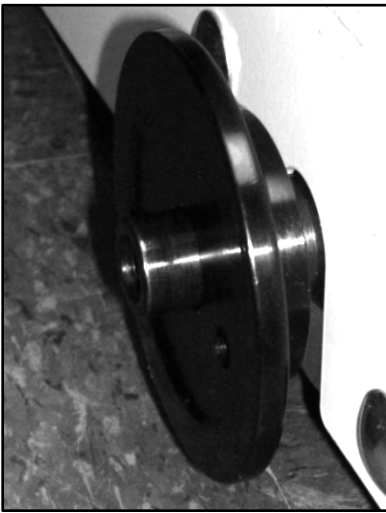

Figure 22: CC1200 Inner Flange

Installing the Inner Blade Flange

1. Inspect the inner blade flange for damages and clean or replace as necessary.
2. Place the flange onto the tapered portion of the blade shaft.
3. Apply Loctite 262 (red) or an equivalent to the setscrew threads.
4. Place the setscrew into the flange's setscrew hole and tighten the screw down to the blade shaft key to secure the flange. *Note: Always make sure the flange is secure prior to operating the saw.*

Removing the Inner Blade Flange

1. Remove the setscrew from the back of the inner blade flange using an Allen wrench.
2. Remove the flange from the blade shaft.

Wheels

! WARNING

- Raise the saw to a proper height for easy access when working underneath the saw, and place jack stands or blocks under frame edges at the front and back of the frame.
- Always wear safety glasses when removing retaining rings.



Front Wheels

Inspect the front wheels regularly for damages or wear and replace as necessary.



Figure 23: CC1300XL Front Wheels

1. Raise the saw to gain access to the front wheels.
2. Remove the setscrews from the set collar (CC1200). Remove the retaining ring using retaining-ring pliers (CC1300XL).
3. Remove the set collar and wheel from the wheel shaft (CC1200). Remove the washer and wheel from the wheel shaft (CC1300XL).
4. Place a new wheel onto the wheel shaft and slide it to the back of the shaft.
5. Place the set collar against the wheel on the wheel shaft (CC1200). Place the washer against the wheel on the wheel shaft (CC1300XL).
6. Tighten the setscrews into the set collar to secure the wheel (CC1200). Snap the retaining

ring into the groove at the front of the wheel shaft to secure the wheel (CC1300XL).

7. Repeat steps 2–6 to replace the second wheel.

Rear Wheels

Inspect the rear wheels regularly for damages or wear and replace as necessary.



Figure 24: CC1200 Rear Wheels

1. Remove the setscrews from the set collar.
2. Remove the set collar and wheel from the wheel shaft.
3. Place a new wheel onto the wheel shaft and slide it to the back of the shaft. *Note: Make sure the spacer washer is behind the wheel (CC1200).*
4. Place the set collar up against the wheel on the wheel shaft.
5. Tighten the setscrews into the set collar to secure the wheel.
6. Repeat steps 1–5 to replace the second wheel.

Blade Drive Belts

! WARNING

- Turn off the engine prior to performing belt maintenance.



! CAUTION

- Always let the belts cool down prior to performing belt maintenance.

Note: Over-tensioning the belts may damage the engine crankshaft. Under-tensioning the belts may cause shorter belt life and/or poor saw performance. Squealing belts indicate looseness.

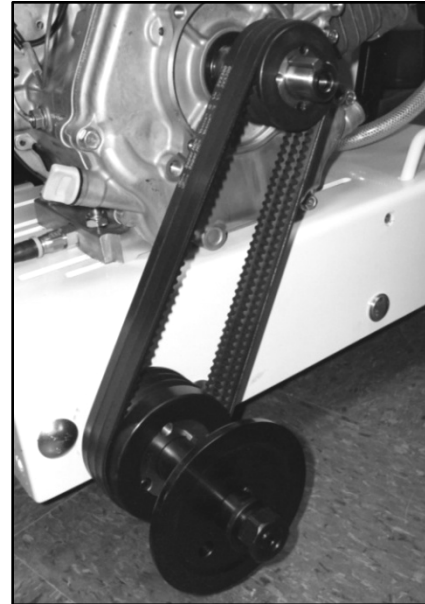

Figure 25: CC1300XL Belts

Tensioning the Blade Drive Belts

1. Inspect the belts for fraying, stress cracks, and/or breakage and replace immediately when damaged.
2. Test the belt tension. Proceed to step 3 if the belts need tensioning (refer to the Belt Tension Settings in the Index for proper tension setting). Operate the saw as needed if no tension adjustments are required.
3. For engines without the adapter plate or adapter mounts; there are four screw/nut assemblies securing the engine/motor to the frame through the frame slots. Loosen the nut on each screw.
4. For engines with the adapter plate or adapter mounts; there are four screw/nut assemblies securing the adapter plate or adapter mounts to the frame through the frame slots. Loosen the nut on each screw.

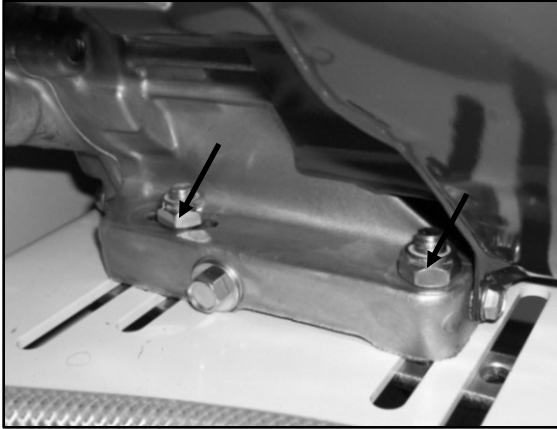

Figure 26: Engine without Adapter Plate/Mounts

5. Turn the belt adjustment shaft nut clockwise to tighten the belts.

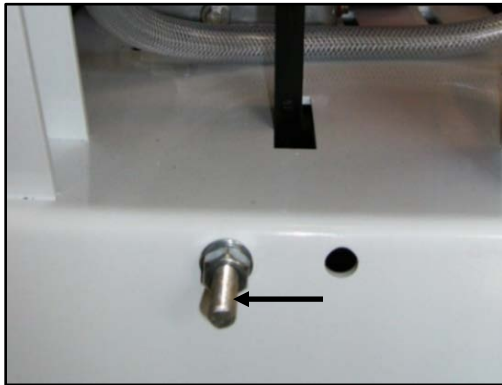

Figure 27: Adjustment Shaft and Nut

6. Readjust the nut as necessary to reach the required tension setting. Refer to the Index for the belt tension settings. DO NOT exceed the manufacturer's tension setting.
7. Retighten the four nuts to secure the engine/motor, adapter plate, or adapter mounts.



Replacing the Blade Drive Belts

1. For engines without the adapter plate or adapter mounts; there are four screw/nut assemblies securing the engine/motor to the frame through the frame slots. Loosen the nut on each screw.
2. For engines with the adapter plate or adapter mounts; there are four screw/nut assemblies securing the adapter plate or adapter mounts to

the frame through the frame slots. Loosen the nut on each screw.

3. Turn the belt adjustment shaft nut counterclockwise to loosen the belts.
4. Remove the belts from the crankshaft sheave and from the blade shaft sheave.
5. Loop and align the new belts around the blade shaft sheave, and then pull them up and loop and align them around the crankshaft sheave.
6. Turn the belt adjustment shaft nut clockwise to tighten the belts. Readjust the nut as necessary to reach the required tension setting. Refer to the Index for the belt tension settings. DO NOT exceed the manufacturer's tension setting.
7. Retighten the four nuts to secure the engine/motor, adapter plate, or adapter mounts.

Engine/Motor

 WARNING	
<ul style="list-style-type: none"> • Let the engine/motor cool down prior to performing maintenance. 	

Refer to the engine/motor manual and manufacturer for a full maintenance schedule and additional maintenance information.

Cleaning the Engine/Motor

Wipe down the engine/motor exterior and guards daily or regularly to prevent high operating temperatures. DO NOT spray the engine/motor with water to prevent engine damage.

Storing

Complete the tasks listed below prior to storing the saw for longer time frames:

- Lower the saw completely to remove any strain on the lifting mechanism.
- Turn off all switches and controls.
- Disconnect the water supply hose from the blade guard and open the water valve to drain water from the water lines/hoses.
- Clean the blade guard water tubes using a wire brush and rinse with a hose.
- Clean and wipe down the saw.
- Store the saw in a cool, dry area out of reach from children.

- Refer to the engine/motor manual for engine tasks prior to storing the saw.

Disposal

Properly dispose of the saw when it's no longer repairable, and/or contains safety hazards not worth repairing or maintaining. Complete the tasks listed below to properly dispose of the saw when discontinuing usage:

- Drain all fluids from the saw and dispose according to city, state, and federal regulations.
- Secure the saw in a truck/trailer and transport it to a salvage yard or recycling facility for appropriate disposal.

Index

Serial Tags

Saw Serial Tag

Record the saw's serial number below for future reference and customer service purposes.

Serial Number	
---------------	--

Engine/Motor Serial Tag

Record the engine's model and serial numbers below for future reference and customer service purposes.

Model Number	
Serial Number	

Daily Maintenance Task Chart

Table 7: Daily Maintenance Task Chart								
Date								
		✓	✓	✓	✓	✓	✓	✓
1.	Lubricate blade shaft bearing grease fittings daily, or two to three times daily when dry cutting.							
2.	Inspect belts after first four hours of use, and then daily for tension and wear. Replace or re-tension as necessary.							
3.	Inspect saw for damages.							
4.	Tighten loose nuts and bolts.							
5.	Clean air filter daily or two to three times daily when dry cutting (see engine manual).							
6.	Check fuel level and fill as necessary.							
7.	Check engine oil level and fill as necessary (see engine manual).							
8.	Wipe down saw's exterior.							
9.	Wipe down engine/motor exterior and guards.							
10.	Look for fluid leaks.							
<i>Refer to the engine manual for daily engine maintenance tasks.</i>								

Belt Tension Settings

Table 8: CC1200 Belt Tension Settings

Model Number	Engine Type	Belt	Tension Setting
CC1209RS	9HP Robin-Subaru	PJ Type 280-20 Groove	0.11 in. at 0.6 lb Force
CC1209HS	8HP Honda GX270		
CC1213HS	11HP Honda GX390		

Table 9: CC1300XL Belt Tension Settings

Model Number	Engine Type	Belt	Tension Setting
CC1309HS-XL	8HP Honda GX270	3VX315	0.18 in. at 5.7 lb Force
CC1313HS-XL	11HP Honda GX390	3VX300	0.17 in. at 5.7 lb Force
CC1305E1-XL	5HP Baldor Electric 1 PH		
CC1305E3-XL	5HP Baldor Electric 3 PH		
CC1310E3 20-XL	10HP Baldor Electric 3 PH (w/ switchbox and 20" guard)	3VX315	0.18 in. at 5.7 lb Force
CC1313HS 20-XL	11HP Honda GX390 (w/ 20" guard)		

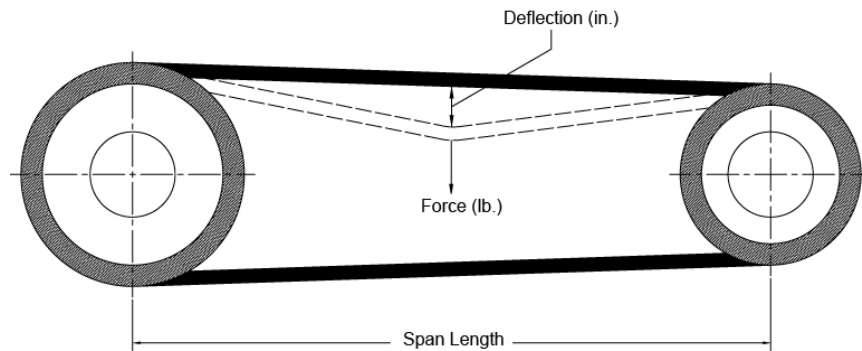

Deflection (in.) should be equal to number of inches listed in chart above when force (lb.) listed in chart above is applied to belt using tension gauge.

Troubleshooting

Table 10: Saw Troubleshooting		
Symptom	Problem	Solution
1. Saw will not raise.	Index plunger in?	Pull index plunger out to move handwheel.
2. Saw will not lower.	Index plunger in?	Pull index plunger out to move handwheel.
3. Blade does not cut straight.	Excessive force applied while sawing?	Reduce forward speed.
	Wrong blade for application?	Contact dealer/manufacturer of blade.
4. Short belt life.	Loose belts causing slippage?	Check belt tension regularly.
	Sheaves misaligned?	Use straightedge to check blade shaft sheave alignment.
	Worn sheave grooves?	Check for groove wear and replace as necessary.
	Overheating of belts?	Check belt tension.
<i>Refer to the engine/motor manual and manufacturer for engine troubleshooting information.</i>		

References

1. Diamond Products (www.diamondproducts.com)
 - *CC1200 Concrete Saw Parts List; Ohio, 2005*
 - *CC1300XL Concrete Saw Parts List; Ohio, 2007*

Additional Resources

1. Diamond Products
 - *A Guide for Professional Concrete Cutters*
 - *Training Manual—Introduction to Diamond Blades, Bits, and Equipment*
 - *Diamond Products' Equipment Catalog*
 - *Diamond Products' Website (www.diamondproducts.com)*
2. Honda Motor Company (www.honda-engines.com)
 - *Owner's Manual; GX240, GX270, GX340, GX390; Japan, 2007*
3. Robin-Subaru (www.robinamerica.com)
 - *Instructions For Use; EX13D/EX17D/EX21D/EX27D; Japan, 2002*
4. Baldor Electric Company (www.baldor.com)
 - *Installation and Operating Manual; MN400; Arkansas, 2007*
5. Concrete Sawing and Drilling Association (CSDA) (www.csda.org)
 - The CSDA has many helpful concrete cutting publications available to members and non-members.
6. Association of Equipment Manufacturers (AEM) (www.aem.org)
 - The AEM has a variety of safety and technical manuals available for various types of equipment, along with a list of industry-standardized safety symbols.
7. Occupational Safety and Health Administration (OSHA) (www.osha.gov)
 - OSHA provides information on work-related safety and health practices.
8. The National Institute for Occupational Safety and Health (NIOSH) (www.cdc.gov/NIOSH)
 - NIOSH provides information on work-related safety and health practices.

