



**CORE CUT  
OPERATOR'S MANUAL**

**CC3538JK  
(Electronic Fuel Injection)**

**May 2020**



## TABLE OF CONTENTS

### Table of Contents

Introduction .....	6
CC3538JK Controls .....	7
CC3538JK Dimensions.....	8
CC3538JK Specifications .....	9
Safety .....	10
Safety Alerts.....	10
Proposition 65 .....	10
Respiratory Hazards .....	10
General Safety .....	11
Battery and Electrical Safety .....	12
Blade Safety.....	12
Blade Guard Safety.....	12
Cutting Safety.....	13
Hydraulic Safety .....	13
Belt Safety .....	13
Transporting Safety.....	14
Lifting Safety .....	14
Operating.....	15
General Operating Precautions.....	15
Handlebars.....	15
Adjusting the Handlebars .....	15
Control Grip Pushbuttons.....	15
Blade Lowering Speed (Optional) .....	16
Spotlight (Optional) .....	16
Fuel System .....	16
Adding Fuel .....	16
<i>Blade Guard</i> .....	16
Installing the Blade Guard .....	17
Removing the Blade Guard .....	17
Flange Guard .....	17
Installing the Flange Guard .....	17
Removing the Flange Guard .....	17
Diamond Blades.....	17
Inspecting the Blade.....	17
Blade Speed .....	18
Wrench .....	18
Installing the Blade .....	18
Removing the Blade .....	19
Engine .....	19
Vernier Throttle.....	20
Tasks Prior to Starting the Engine.....	20
Starting the Engine.....	20
Stopping the Engine .....	20
Transmission Lever.....	20
Engaging the Transmission .....	21
Disengaging the Transmission .....	21
Speed Control Lever .....	21
Water Supply.....	21
Using the Water Supply.....	21

## TABLE OF CONTENTS

Water Pressure Switch (Optional) .....	22
Water Pump (Optional).....	22
Cutting Guides .....	22
Adjusting the Front Pointer .....	22
Adjusting the Rear Pointer(s) .....	22
Concrete Cutting .....	22
Helpful Hints Prior to Cutting .....	23
Tasks Prior to Cutting .....	23
Making a Cut .....	23
Making a Cut Using the Blade Depth Stop .....	24
Continuing a Partial-Cut .....	24
Finishing a Cut.....	24
Parking Brake (Optional).....	24
Engaging the Parking Brake.....	24
Disengaging the Parking Brake .....	24
Maintenance .....	25
General .....	25
Pre Maintenance Preparations.....	25
Rear Cover Screen .....	25
General Cleaning .....	25
Cleaning Techniques.....	25
Engine .....	25
Part Lubrication .....	26
Post Cleaning.....	26
Service Schedule.....	27
Daily Service.....	28
Check Engine Oil Level.....	28
Check Fuel Level.....	28
Hydraulic System .....	28
Adding Fluid to the Hydraulic Lift Pump .....	29
Lubricate the Blade Shaft Bearings.....	29
Belt System .....	29
Tensioning the Drive Belts.....	30
Tensioning the Jackshaft Belts.....	30
100 Hour Service .....	31
Bearing Lubrication .....	31
Lubricate the Jackshaft Bearings .....	31
Lubricate the Front Axle Bearings .....	32
Lubricate the Rear Axle Bearings.....	32
Lubricate the Transmission Jackshaft Bearings .....	32
Lubricate the Linkage Assembly.....	32
Lubricate the Front Wheels .....	33
Replace Engine Oil and Filter .....	33
150 Hour Service.....	34
Clean the Air Cleaner Filter Element.....	34
Replace the Fuel Filter .....	35
300 Hour Service.....	35
Replace the Air Cleaner Filter Elements .....	35
Yearly Service.....	36
Replace and Gap Spark Plugs.....	36

## TABLE OF CONTENTS

Regular Maintenance.....	36
Drive Alignment.....	36
Wheels .....	36
Replacing the Front Wheels .....	37
Replacing the Rear Wheels.....	37
Battery.....	37
Battery Type .....	38
Servicing the Battery .....	38
Speed Control Lever .....	38
Adjusting the Speed Control Lever Linkage .....	38
Adjusting the Speed Control Lever Friction.....	38
Shaft Tachometer Magnetic Sensor (Optional).....	39
Adjusting the Magnetic Sensor.....	39
Replacing the Magnetic Sensor.....	39
Transmission.....	39
Cooling Fan .....	39
Tightening the Rear Drive Chain .....	39
Belt Replacement.....	40
Replacing the Blade Drive Belts .....	40
Replacing the Jackshaft Belts .....	41
Replacing the Transmission Drive Belt.....	41
Belt Sheaves .....	41
Changing the Small and Large Jackshaft Sheaves (14" through 26" Saws).....	41
Changing the Small Jackshaft Sheave (30" Saw), Blade Shaft Sheave, Transmission Sheave, and Engine Sheave .....	42
Aligning the Belt Sheaves.....	42
Engine .....	42
Lifting.....	42
Transporting .....	42
Storing.....	42
Disposal .....	43
Appendix A .....	44
Troubleshooting .....	44
Appendix B .....	45
CC3538JK RPM Chart.....	45
CC3538JK Blade Size Conversion Charts.....	45
Appendix C .....	46
Additional Resources .....	46
Appendix D .....	50
Model and Serial Numbers.....	50

## INTRODUCTION

### **Introduction**

Welcome to the Diamond Products family and thank you for choosing Diamond Products equipment. At Diamond Products we are driven to ensure you are completely satisfied with your product and continually strive to improve our product line so that we can offer you the best possible equipment in the industry.

This operator's manual is a critical document that provides pertinent information regarding the safety, operation, maintenance, and care of your new equipment. Keep this manual available at all times. Operate the equipment and all of its components according to this manual. Failure to comply with and understand the following safety, operation and maintenance instructions can result in serious injuries and/or death. All operators must be properly trained or supervised by experienced personnel prior to using this saw and should understand the risks and hazards involved. Diamond Products discourages improper or unintended equipment usage and cannot be held liable for any resulting damages.

Equipment modifications should be made by Diamond Products to ensure safety and design. Any modifications made by the owner(s) are not the responsibility of Diamond Products and void all equipment warranties if a problem arises as a result of the modification.

Refer to the Diamond Products Parts List for additional information and part diagrams. Refer to the engine manufacturer as the primary source for all safety, operations, and maintenance instructions regarding the engine. Prior to operating, record the saw's serial number, and the engine's model and serial numbers in Appendix D.

**CC3538JK Controls**

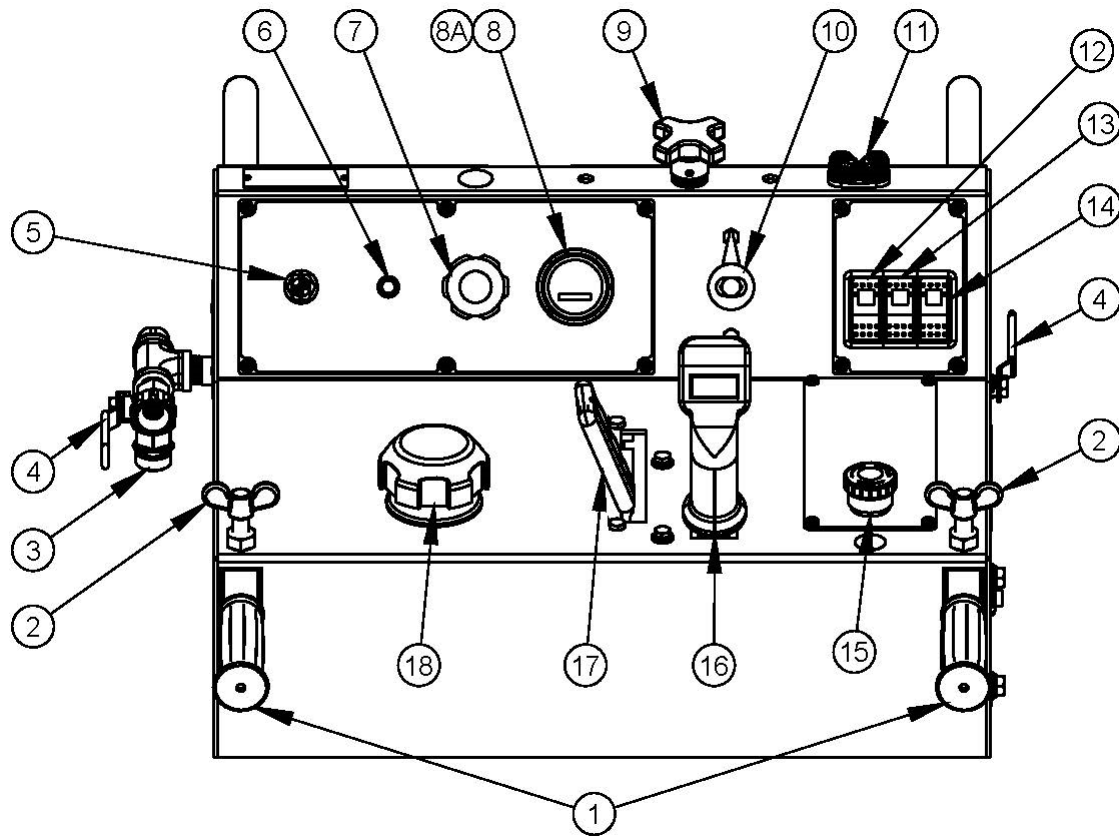

- |   |   |
|---|---|
| <ol style="list-style-type: none"> <li>1. <b>Handlebars</b> – Allows for manual maneuvering of the saw.</li> <li>2. <b>Handlebar Locking Knobs</b> – Locks the handlebars in place.</li> <li>3. <b>Water Hose Fitting</b> – Connects to water source hose or water supply hose.</li> <li>4. <b>Water Valve Lever</b> – Controls water flow to the blade.</li> <li>5. <b>Ignition Switch</b> – Three position switch stops the engine, provides power to accessories, or stops the engine.</li> <li>6. <b>Check Engine Light</b> – Illuminates when there is an issue with the engine.</li> <li>7. <b>Vernier Throttle</b> – Increases or decreases engine speed.</li> <li>8. <b>Hour Meter</b> – Gauge displays the engine's accumulated operational hours.</li> <li>8A <b>Blade Tachometer (Optional)</b> – Indicates blade speed in RPM.</li> <li>9. <b>Depth Stop Knob</b> – Allows operator to set the cutting depth and increase or decrease the cutting depth.</li> <li>10. <b>Cutting Depth Indicator</b> – Displays the current depth of cut in inches.</li> <li>11. <b>Pointer Rope Cleat</b> – Secures the front pointer rope.</li> </ol> | <ol style="list-style-type: none"> <li>12. <b>Water Pump Switch (Optional)</b> – Activate water pump.</li> <li>13. <b>Water Pressure Switch (Optional)</b> – Indicates low water pressure to the blade. <i>Note: The switch does not detect flow.</i></li> <li>14. <b>Spotlight Switch (Optional)</b> – Activates spotlight.</li> <li>15. <b>Emergency Stop Button</b> – Stops the engine.</li> <li>16. <b>Speed Control Lever</b> – Provides forward, reverse, and stop control.</li> <li>17. <b>Transmission Lever</b> – Manually engages and disengages the transmission.</li> <li>18. <b>Fuel Tank Cap</b> – Fuel port; indicates fuel level.</li> </ol> <p><i>Items Not Shown Above:</i></p> <ol style="list-style-type: none"> <li>19. <b>Blade Lowering Speed Valve (Optional)</b> – Controls the lowering speed of the saw.</li> <li>20. <b>Parking Brake Lever (Optional)</b> – Engages or disengages the parking brake.</li> <li>21. <b>Spotlight (Optional)</b> – Provides a working area light source.</li> </ol> |
|---|---|

## INTRODUCTION

### CC3538JK Dimensions

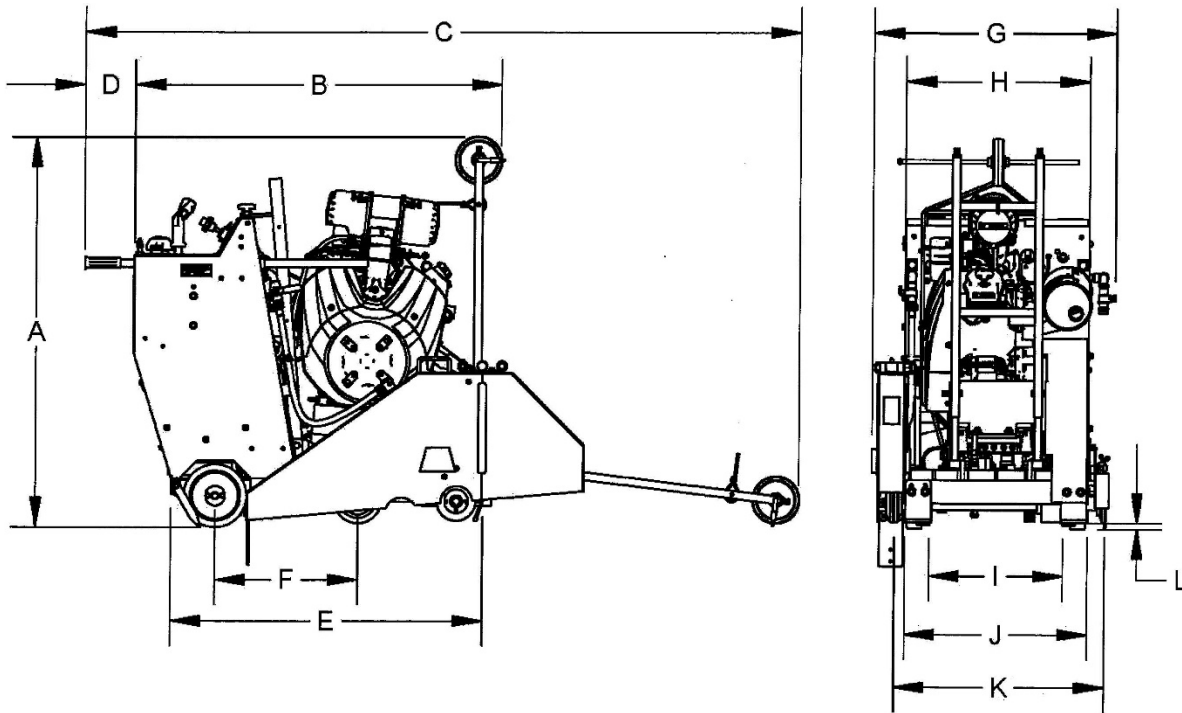

CC3538JK Dimensions		Inches	Millimeters
A	Saw Height	43	1092
B	Saw Length - Min.	46-3/4	1187
C	Saw Length - Max.	125-1/2	3188
D	Handle Extension - Max.	28	711
E	Frame Length	39-3/4	1010
F	Wheel Base Length	18-1/4	464
G	Saw Width	30-1/4	768
H	Rear Frame Width	23-1/2	597
I	Front Wheels Inside Width	20-1/4	514
J	Rear Wheels Outside Width	22-1/2	572
K	Inner Flange to Inner Flange Width	26-3/4	679
L	Blade Raise Height - Max.	17	432



## INTRODUCTION

### CC3538JK Specifications

CC3538JK Specifications				
Saw Model	CC3538JK-14	CC3538JK-20	CC3538JK-26	CC3538JK-30
Blade Guard Capacity	14" (350mm)	20" (500mm)	26" (700mm)	30" (800mm)
Blade Cutting Depth Max	4.5"	7.5"	10.5"	12.5"
Blade Shaft Speed <sup>(1)</sup>	3000 rpm	2500 rpm	1900 rpm	1650 rpm
Blade Flange Size	5" OD	5" OD	5" OD	5" OD
Engine Model	Kohler Command Pro ECH980			
Rated Output Power	38 HP			
Rated Speed	3600 rpm (Kohler rating)			
Battery	12 Volt (630 CCA) group size 34			
Saw Lift Pump Fluid	Automatic Transmission Fluid (ATF); (2 Liter capacity)			
Lubrication Type	NLGI #2 Lithium grease			
Blade Arbor Size	1" Diameter with drive pin			
Blade Flange Style	Quick disconnect			
Blade Shaft Size	1-3/4" OD with left/right side blade mounting			
Blade Shaft Bearings	2 Pillow blocks with spherical roller bearings			
Jackshaft Drive (Engine to Jackshaft)	6 V-Belts (3VX366)	6 V-Belts (3VX400)		
Blade Shaft Drive (Jackshaft to Blade Shaft)	6 V-Belts (3VX400)			
Blade Coolant	Dual stainless steel multi-jet spray tubes			
Blade Guard Attachment	Slip-on tapered spade			
Blade Raise and Lower	Electro-hydraulic power unit with push button control			
Blade Lowering Speed	Flow control valve (Optional)			
Blade Depth Control	Dial depth indicator and manual depth stop			
Blade Alignment	Telescoping front/rear left and right pointers			
Axle Size (Front/Rear)	Front: 1" OD straight / Rear: 1.25" OD straight			
Front Wheels	6" x 2" with 1" poly tread (sealed roller bearings)			
Rear Wheels	8" x 2-1/2" with 1-1/4" poly tread			
Travel Speed	0-200 FPM (2.25 mph) forward/reverse			
Rear Wheel Transmission	Eaton Model 10 transmission with chain drive			
Transmission Belt	V-Belt (4L600W)			
Rear Wheel Drive	Gear drive			
Parking Brake	Manual rear wheel friction (optional)			
Handle Bar Adjustment	Variable extension with dual 0° and 30° angle range			

(1) Theoretical speed, actual speed may vary.

## SAFETY PRECAUTIONS

### Safety

Operate the equipment and all of its components according to this manual. Failure to comply with and understand the following safety, operation and maintenance instructions can result in serious injuries and/or death. All operators must be properly trained or supervised by experienced personnel prior to using this saw and should understand the risks and hazards involved. Diamond Products discourages improper or unintended equipment usage and cannot be held liable for any resulting damages.

Equipment modifications should be made by Diamond Products to ensure safety and design. Any modifications made by the owner(s) are not the responsibility of Diamond Products and void all equipment warranties if a problem arises as a result of the modification.

Refer to the Diamond Products Parts List for additional information and part diagrams. Refer to the engine manufacturer as the primary source for all safety, operations, and maintenance instructions regarding the engine. Prior to operating, record the saw's serial number, and the engine's model and serial numbers in Appendix D.

**Notice: The information in this manual may be updated at any time!**

### **Safety Alerts**



#### **DANGER**

Serious injuries and/or death will occur if these instructions are not followed.



#### **WARNING**

Serious injuries and/or death could occur if these instructions are not followed.



#### **CAUTION**

Mild and/or moderate injuries could occur if these instructions are not followed.

### **Proposition 65**

#### **PROPOSITION 65**



**WARNING:** Concrete cutting produces dust that can expose you to chemicals including Silica, crystalline (airborne particles of respirable size), which is known to the state of California to cause cancer. For more information go to:

**[WWW.P65WARNINGS.CA.GOV](http://WWW.P65WARNINGS.CA.GOV)**

### **Respiratory Hazards**



#### **WARNING**

Concrete cutting produces dust and fumes known to cause illness, death, respiratory disease, birth defects, and/or other reproductive harm. Safety protection techniques include, but are not limited to:

- Wearing gloves.
- Wearing safety goggles or a face shield.
- Using approved respirators.
- Washing work clothes daily.
- Using water when wet cutting to minimize dust.
- Washing the hands and face prior to eating/drinking.

For additional safety and self-protection information contact your employer, the Occupational Safety and Health Administration (OSHA), and/or The National Institute for Occupational Safety and Health (NIOSH).

## SAFETY PRECAUTIONS

### General Safety

- Read and understand all safety, operations, and maintenance instructions provided in this manual prior to operating or servicing the saw.
- Keep equipment components clean and free of slurry, concrete dust, and debris.
- Inspect water hoses prior to operating the equipment. Clean, repair, or replace damaged components.
- Raise the equipment to a proper height for access when working underneath the equipment. Use chocks to block the wheels, and fit blocks or jacks under the frame edges.



### WARNING

Do NOT work on equipment using the hydraulic lift system to keep the equipment in the raised position for maintenance or repair. Accidental loss of hydraulic pressure could cause the equipment to drop suddenly, resulting in serious injury or death.

- When using a jack to raise the equipment, place the jack against a solid, flat area under the frame base to properly support the equipment.
- Repair the equipment immediately when a problem arises.
- Replace equipment decals if unreadable.
- Dispose of all hazardous waste materials according to city, state, and federal regulations.
- Always have a phone nearby, and locate the nearest fire extinguisher and first aid kit prior to operating the equipment.
- Operate the equipment wearing flame resistant clothing.
- Always wear safety glasses when removing retaining rings.
- Underage or non-trained personnel should not operate the equipment.
- Keep all body parts away from rotating machinery.
- Replace all guards and access panels (unless stated otherwise) prior to operating the equipment.
- Always pivot front of blade guard fully closed to avoid serious injuries.

### DO NOT:

- Assume the equipment will remain still when in STOP or when parking/stopping the equipment on a slope. Chock the wheels to help prevent unnecessary movement.
- Drop equipment, supplies, tools, etc., when handling to help prevent injuries.
- Lift and carry equipment, supplies, tools, etc., that are too heavy and/or cannot be lifted easily.

- Operate the equipment without using the appropriate safety equipment required for the work task.



- Operate or service the equipment with any clothing, hair, or accessories that can snag in the machinery, which could lead to serious injuries or death!
- Operate the equipment using attachments not associated with or recommended for the equipment.
- Operate the equipment around combustible materials.
- Operate the equipment with anyone near the work area or within the direct line of the blade.
- Operate the equipment until all unnecessary materials have been removed from the work area.
- Operate the equipment with loose nuts, screws, and bolts.
- Operate the equipment when ill or fatigued.
- Operate the equipment under the influence of drugs and/or alcohol.
- Operate the equipment on steep slopes.
- Cut concrete with guards and access panels removed.
- Grease the equipment with the engine running.
- Touch hot components when operating the equipment.
- Leave the equipment unattended until the engine is off and the blade has stopped.
- Place the equipment into storage until it has cooled down.
- Service the equipment until it has cooled down.
- Service the equipment with the engine running.

## SAFETY PRECAUTIONS

### Battery and Electrical Safety

- Ignitable explosive gases are emitted from the battery. DO NOT expose the battery to sparks or open flames. 
- Keep the area around the battery well-ventilated.
- Keep the battery level when handling it.
- Use protective eyewear or a face shield, and avoid contact with the skin when handling/servicing the battery.
- Use a proper battery tester when testing the battery strength.
- Always be sure to connect the battery cables to the proper terminal when reconnecting the cables.
- Occasionally inspect the battery, cables, clamps, and terminals for damages. Service components as necessary.
- Always keep the battery cable clamps away from the battery terminals when the battery is disconnected to avoid accidental connections while servicing.
- Immediately rinse your clothing, skin, or eyes with water if exposed to battery acid. Seek medical attention immediately!
- Disconnect the battery prior to servicing all equipment components (unless stated otherwise).
- Remove the battery when storing the equipment for longer periods.
- Always use the correct size fuses (amps) to prevent fires.

### Blade Safety

- Always use reinforced abrasive blades or steel-centered diamond blades.
- Never use a wet cutting blade without an adequate water supply to properly lubricate the blade.
- Inspect all blades prior to usage and discard damaged blades.
- DO NOT install or remove a blade with the engine running.
- Keep all body parts away from rotating blades.
- Inspect the blade flanges for damages, wear, and cleanliness. Clean or replace dirty/damaged components immediately.

- DO NOT expose yourself or anyone else to the direct line of the blade when operating the equipment.



- Always use an appropriate size blade and the correct blade type based on the cutting task and the type of material being cut.
- The blade must always fit snug on the blade shaft, outer flange, and/or inner flange.
- Wear gloves and be alert to the surrounding environment when handling blades.
- When installing the blade, always point the arrow printed on the blade in the direction of the blade shaft's rotation.
- DO NOT exceed the blade's maximum recommended speed when cutting. Excessive blade speeds can cause blade breakage, resulting in serious injuries and/or death!
- DO NOT use damaged blades when cutting to avoid harming yourself, others, or the equipment.
- DO NOT use a blade for cutting that requires a lower speed than the blade shaft speed.
- Always tighten the blade shaft bolt/screw as directed to properly secure the outer flange and blade. Failure to properly secure the outer flange and blade may cause parts to loosen or fall off the equipment, resulting in serious injuries or death!
- Let the blade cool prior to removal when dry cutting (applicable models).

### Blade Guard Safety

- DO NOT operate the equipment with the blade guard raised or removed.
- Blade exposure should not exceed 180° while cutting.
- When pivoting the front of the blade guard, raise/lower it cautiously and slowly to avoid serious injuries.
- DO NOT pivot the blade guard front up or down when installing/removing very large blades. Attempting to pivot the front of a heavy guard when the guard is positioned higher up for blade installation/removal makes the guard difficult to lift and/or lower. In this situation, install/remove the blade guard front instead of pivoting it.

## SAFETY PRECAUTIONS

- Always pivot the front of the blade guard 180° (fully upward) so the guard does not swing down unexpectedly, causing serious injuries.



- Always secure the pivoted section of the blade guard using the detent pin (guards 26" and up).
- Use extreme caution when installing/removing parts of a guard or the entire guard as guards can be extremely heavy and may require installation/removal at moderate heights.
- DO NOT install or remove the blade guard with the engine running.
- Always use a blade guard that corresponds with the blade size.
- Inspect the blade guard and water tubes prior to starting the equipment. Clean or replace dirty/damaged components immediately.

### Cutting Safety

- The direct work area should not contain buried or embedded electrical, gas, or water lines that could be damaged and/or cause personal injury while cutting.
- Turn off all electricity, gas, and water around the direct work area prior to cutting.
- Inspect the work area to ensure nothing will impede full control of the machine at all times.
- DO NOT expose yourself or anyone else to the direct line of the blade when operating the equipment.
- DO NOT allow any person, animal, and/or objects in and around the work area while cutting.
- DO NOT install a blade on the machine until it is in the cutting area.
- Ensure the work area is adequately illuminated to ensure safe operation of the machine.

### Hydraulic Safety

- Turn off the engine prior to servicing hydraulic components.
- Lower the equipment completely prior to servicing to decrease the hydraulic pressure in the lines.
- Always make sure any hydraulic components being serviced are not supporting the weight of other equipment components. If a particular component is under pressure when connection points are loosened, oil may spray out forcefully.

- Always place a piece of cardboard or paper up against hydraulic components, or use a leak detection fluid to check for hydraulic fluid leaks. Keep all body parts away from leaks and/or areas that may eject hydraulic fluid. Pressurized hydraulic fluid can penetrate the skin, causing serious injuries. Seek medical attention immediately!



### Belt Safety

- Turn off the engine and let the belts cool down prior to servicing them.
- Regularly inspect the belts for fraying, stress cracks, and/or breakage and replace immediately when damaged. Always check the belt alignment prior to operating the equipment.
- Use extreme caution when working with belts and rotating machine parts to avoid entanglement.
- Over-tensioning belts may reduce the life of the gearbox bearings. Under-tensioning belts may cause slippage, shorter belt life, and/or poor equipment performance.
- Squealing belts indicate looseness.
- DO NOT use old and new belts together on the same sheave.

## SAFETY PRECAUTIONS

### Transporting Safety

- Remove the blade prior to transporting the equipment.
- Make sure the truck/trailer is in good, working condition and sufficient to transport the load. DO NOT tow the equipment behind a vehicle.
- Use heavy-duty ramps that will support the weight of the equipment and yourself when loading or unloading.
- Raise the equipment to avoid damaging components while moving up and down ramps.

- Use extreme caution when guiding the equipment up and down ramps. Slowly drive the equipment forward down the ramp. Slowly back the equipment in reverse up the ramp. Avoid standing directly downhill from the equipment to prevent machine rollover.



- Place the equipment in STOP and turn off the engine once the equipment is loaded in the truck/trailer.
- Chock the wheels and secure the saw in the truck/trailer prior to transporting.
- Refer to the Department of Transportation (DOT) for additional transportation recommendations.

### Lifting Safety

- Move yourself and all others away from the lifting area when hoisting the saw to prevent being crushed.



- Secure the appropriate hoisting cables, straps, and/or chains to the saw's designated lift points prior to hoisting.
- Never use the tie-down brackets (applicable models) to lift the saw.
- DO NOT attempt to lift the saw irresponsibly and/or improperly.

## Operating

### **General Operating Precautions**

- Prior to operating the machine, read the operator's manual thoroughly and ensure that you understand the safe and proper operation of the machine.
- Use approved personal protective equipment at all times while operating the machine.
- Ensure that there is firefighting equipment and a first aid kit nearby while operating the machine.
- Ensure the cutting area is free of obstructions, people, and or animals prior to operating the machine.
- Always operate the machine from the operator's position at the rear of the machine between the handlebars.
- Do not stand in front or behind the blade path while the engine is running.

### **Handlebars**

The handlebars help to guide and maneuver the saw.

### **Adjusting the Handlebars**

1. Loosen both of the handlebar lock knobs.
2. Hold the handlebar grip and place the first handlebar into the handlebar opening below the handle lock knob. The handlebar can fit through two different angled pathways inside the handlebar opening. Select the handlebar angle that works best for the current task.
3. Move the handlebar forward or backward to adjust the length.

*NOTE: Maintain a minimum of 6" of handlebar into the handlebar tube at all times.*

4. Tighten the handlebar lock knob to secure the handlebar.

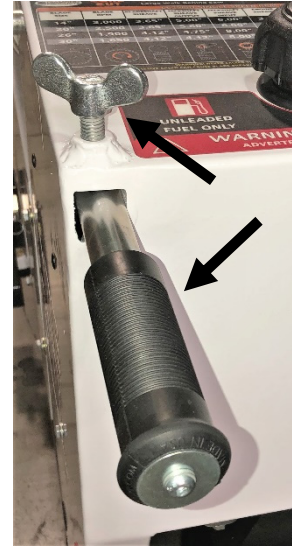

**Handlebar and Lock Knob**

5. Repeat steps 2 – 4 to secure the second handlebar. Adjust the handlebar orientation and length prior to operating the saw.

### **Control Grip Pushbuttons**

The control grip pushbuttons raise and lower the saw and blade (buttons work with engine off).



**Control Grip Pushbuttons**

1. Press the *Raise* (left) pushbutton to raise the saw and blade, and release to stop.

*Note: Always raise the blade when maneuvering the saw to provide proper clearance between the blade and the ground.*

2. Press the *Lower* (right) pushbutton to lower the saw and blade, and release to stop.

## Blade Lowering Speed (Optional)

Turn the *Blade Lowering Speed* valve counterclockwise to increase the blade's lowering speed and clockwise to decrease the blade's lowering speed.

*Note: The valve does not adjust the blade's raising speed.*



**Blade Lowering Speed Valve**

## Spotlight (Optional)

1. Loosen both spotlight bar lock knobs and slide the bar from side to side to adjust the length of the bar.



**Spotlight and lock knobs**

2. Tighten the lock knobs to secure.
3. Turn the spotlight switch *ON* or *OFF* as needed for additional lighting.

## Fuel System

### ! WARNING

- Always use caution when refueling.
- DO NOT operate the saw with a fuel leak.
- DO NOT fuel the saw with the engine running.
- DO NOT smoke or expose fuel to open flames when filling the fuel tank or working with fuel.



### ! CAUTION

- Clean up any spilled fuel prior to starting the engine.
- Fuel may seep out from the fuel cap vent (applicable models) when raising the saw if the fuel tank is overfilled.

## Adding Fuel

1. Lower the saw to level the frame.
2. Turn the ignition switch to *OFF* and let the engine cool down.
3. Remove the fuel tank cap.
4. Fill the fuel tank using unleaded gasoline with a minimum of 87 octane. DO NOT overfill the tank for expansion purposes. Refer to the engine manual for additional information on appropriate fuels in normal and cold weather temperatures.
5. Replace the fuel tank cap and secure.

## Blade Guard

### ! WARNING

- DO NOT operate the saw with the blade guard raised or removed.
- DO NOT remove the blade guard with the engine running.
- Blade exposure should not exceed 180° while cutting.
- Always pivot the front of the blade guard 180° (fully upward) so the guard does not swing down unexpectedly, which may cause serious injuries.
- Always secure the pivoted section of the blade guard using the detent pin (guards 26" and up).
- When pivoting the front of the blade guard, raise/lower it cautiously and slowly to avoid serious injuries.



The blade guard shields the blade and must always be in place when operating the saw. Blade guards generally stay in place at all times, except for when changing to another guard size or when using the guard on the opposite side of the saw. Regularly inspect the blade guard and water tubes. Clean, repair, or replace dirty or damaged components immediately.

*Note: Always use a guard size that matches the blade size. Refer to the CC3500J Parts List for additional information.*



## **Installing the Blade Guard**

Always install the blade guard with the blade off the saw.

1. Holding the blade guard handle, face the front of the blade guard forward and fit the tapered mount on the side of the guard onto the tapered mount on either the frame base (right side of saw) or the belt guard (left side of saw).

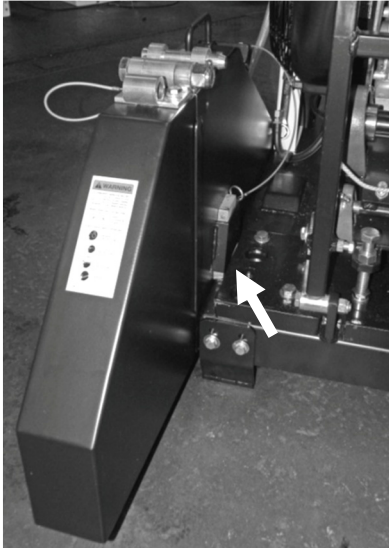

**Frame Base Mount**

2. Insert the lock pin through the hole on the tapered mount to secure the guard.
3. Connect the water supply hose to the blade guard.

## **Removing the Blade Guard**

Always remove the blade guard with the blade off the saw.

1. Disconnect the water supply hose from the blade guard.
2. Remove the lock pin from the tapered mount.
3. Use the handle on the blade guard to rock the guard back and forth while lifting the guard off the tapered frame base or belt guard mount.

## **Flange Guard**

Install the flange guard over the flange assembly not in use for protection against dust, debris, and slurry.

*Note: Secure the blade shaft bolt not in use to the front of the flange guard.*

## **Installing the Flange Guard**

1. Fit the tapered mount on the back of the flange guard onto the tapered mount on either the frame base (right side of saw) or the belt guard (left side of saw).
2. Insert the lock pin through the hole on the tapered mount to secure the guard.

## **Removing the Flange Guard**

1. Remove the lock pin from the tapered mount.
2. Remove the flange guard from the tapered mount.

## **Diamond Blades**



### **WARNING**

- DO NOT exceed the blade's maximum recommended speed when cutting. Excessive blade speeds can cause blade breakage, resulting in serious injuries and/or death.
- DO NOT use damaged blades when cutting to avoid harming yourself, others, or the saw.



Using the proper blade (size and type) preserves the blade and improves efficiency, resulting in lower costs. Refer to the Association of Equipment Manufacturers (AEM) safety brochure for diamond blades and [www.diamondproducts.com](http://www.diamondproducts.com) for additional blade information.

## **Inspecting the Blade**

Inspect each blade prior to installation and discard all damaged blades. Inspect the blades for:

- Cracks, nicks, and dents
- A damaged/deformed arbor (center hole)
- Darkness/discoloration near edge of blade
- A deformed blade circumference
- Segment loss/cracks
- Core wear
- Bending
- Uneven side-widths

## Blade Speed

Refer to the CC3538JK RPM Chart, the blade, or the blade packaging information for the recommended blade speeds when cutting. DO NOT exceed the maximum recommended blade speed. DO NOT use a blade for cutting that requires a lower speed than the minimum blade shaft speed.

## Wrench

Use the wrench provided when installing or removing a blade. Apply force to the opposite end of the wrench and tighten the blade shaft bolt/screw to 125 ft-lb (169.5 Nm) to secure the outer flange and blade. Verify this measurement with a torque wrench.

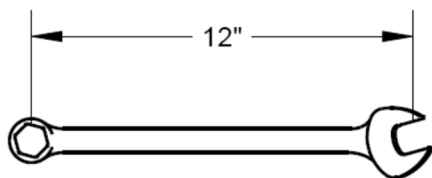

Wrench

## Installing the Blade

### **WARNING**

- DO NOT install a blade with the engine running.
- Failure to properly secure the outer flange and blade may cause parts to loosen or fall off the saw, resulting in serious injuries or death!
- DO NOT pivot the front of the blade guard up or down when installing very large blades. Attempting to pivot the front of a heavy guard when the guard is positioned higher up for blade installation makes the guard difficult to lift and/or lower. In this situation, remove the blade guard front instead of pivoting it.
- Always secure the pivoted section of the blade guard using the detent pin (guards 26" and up).



### **CAUTION**

- Wear gloves and be alert to the surrounding environment when handling blades.

The blade can be installed on the right or left side of the saw. Install the blade on the side preferred or most appropriate for the cutting task.

1. Select a blade size and type. Remember to check the blade for damages and discard as necessary.

*Note: If changing the blade size, adjust and/or change all necessary saw components according to the information in the CC3500J Parts List.*

2. Remove the detent pin (guards 26" and up) from the guard hinge and pivot the front of the blade guard 180° (fully upward) to gain access to the blade flanges.

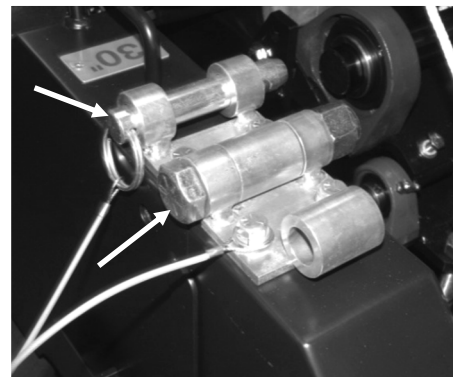

Detent Pin and Hinge Screw

3. On pivoted guards, insert the detent pin through the interlocking barrels on the top of the guard to secure the front of the guard.

*Note: Failure to fully pivot and secure the front of the guard may cause serious injuries.*

4. Remove the blade shaft screw (clockwise loosens on right side, counterclockwise loosens on left side) using the wrench.
5. Carefully remove the outer flange. Inspect the flange assembly and clean or replace dirty/damaged components.
6. Place the blade against the inner flange. For large blades, carefully roll the blade up to the inner flange. Adjust the height of the saw to align the flange and blade arbor.

*Note: Point the arrow printed on the blade in the direction of the blade shaft's rotation.*

7. Align and fit the outer flange and flange pin through the blade and into the inner flange and blade shaft.

*Note: The outer flange should fit snug with the blade, inner flange, and blade shaft.*

8. Slightly rotate the outer flange and blade backward to eliminate backlash (looseness) between parts.
9. Place the wedge lock washer onto the blade shaft screw and insert the screw into the blade shaft through the center of the outer flange.
10. Tighten the screw by hand (use left-hand threaded screw on right side of saw only). Slowly lower the saw, if necessary, until the blade just touches the ground.
11. Tighten the screw again, using the wrench, to 125 ft-lb (169.5 Nm) to secure the outer flange and blade. Verify this measurement with a torque wrench.
12. Remove the detent pin (guards 26" and up) from the guard hinge and pivot the front of the guard down over the blade to secure. Reinsert the pin through the double barrel.

### Removing the Blade



#### CAUTION

- DO NOT remove a blade with the engine running.
- DO NOT pivot the front of the blade guard up or down when removing very large blades. Attempting to pivot the front of a heavy guard when the guard is positioned higher up for blade removal makes the guard difficult to lift and/or lower. In this situation, remove the blade guard front instead of pivoting it.
- Always secure the pivoted section of the blade guard using the detent pin (guards 26" and up).



1. Remove the detent pin (guards 26" and up) from the guard hinge and pivot the front of the blade guard 180° (fully upward) to gain access to the blade.
2. On pivoted guards, insert the detent pin through the interlocking barrels on the top of the guard to secure the front of the guard.

*Note: Failure to fully pivot and secure the front of the guard may cause serious injuries.*

3. Slowly lower the saw, if necessary, until the blade just touches the ground.
3. Remove the blade shaft screw using the provided wrench.
4. Carefully remove the outer flange and blade. Place the blade in an appropriate storage location.

*Note: If the outer flange is difficult to remove, tighten a setscrew into two of the holes on the outside of the outer flange to help separate the outer flange from the blade. Remove the setscrews when separated.*

5. Inspect the flange assembly and clean or replace dirty/damaged components.
6. Carefully fit the outer flange back into the inner flange and/or blade shaft.
7. Place the wedge lock washer onto the blade shaft screw and insert the screw into the blade shaft through the center of the outer flange.
8. Retighten the blade shaft screw to secure the flanges.
9. Remove the detent pin (guards 26" and up) from the guard hinge and pivot the front of the guard down over the blade flanges to secure. Reinsert the pin through the double barrel.

### Engine



#### WARNING



- Operate the saw in well-ventilated areas. Concentrated engine exhaust can cause loss of consciousness and/or death.
- DO NOT touch the engine/muffler with the engine running, and always let them cool down prior to touching or servicing the saw.
- DO NOT leave the saw unattended while the engine is running.

## Vernier Throttle



**Vernier Throttle**

1. Turn the *Hold/Release* knob counterclockwise to loosen the knob.
2. Turn the throttle counterclockwise to increase the engine speed or push in the throttle's spring-loaded tip and pull the throttle out to increase the engine speed. Turn the throttle clockwise to decrease the engine speed or push in the throttle's spring-loaded tip and push the throttle in to decrease the engine speed.

*Note: The engine must run at half throttle or greater when maneuvering the saw with power.*

3. Turn the *Hold/Release* knob clockwise to tighten the knob and secure the engine speed.

### Tasks Prior to Starting the Engine

Complete the tasks listed below prior to starting the engine to ensure a safe start:

- Check fluids and fill to appropriate levels.
- Place speed control lever at *STOP*.
- Disengage transmission.
- Turn off controls and switches.
- Remove tools from area.

*NOTE: The engine will not start with the emergency stop button pushed down. Always pull out the emergency stop button prior to operating the saw.*

## Starting the Engine

*Note: In an emergency, press the emergency stop button to immediately stop the engine and any saw movement!*

1. Open the fuel shutoff valve.
2. Insert the key into the ignition, turn it to *START*, and release when the engine starts. Refer to the information in the engine manual when starting the engine in cold weather.

*Note: If the engine does not start within 10 seconds, turn off the key and try again approximately 30 seconds later. Refer to the engine manual for troubleshooting recommendations after several failed attempts.*

3. Let the engine warm up for several minutes. Check all warning lights and turn off the engine immediately to fix any problems prior to operating the saw.
4. Adjust the engine speed as necessary for maximum efficiency while operating. Refer to the engine manual for additional information.

## Stopping the Engine



- DO NOT leave the saw unattended until the engine is off and the blade has stopped spinning.

1. Place the speed control lever at *NEUTRAL* and raise the blade from the cut.
2. Turn off all controls, switches, and water.
3. Decrease the engine speed to idle for five minutes to cool down the engine.
4. Turn the ignition key to *OFF* and remove the key.

## Transmission Lever

Disengage the transmission prior to starting the engine to prevent unnecessary saw movement.

*Note: The engine must run at half throttle or greater for proper transmission efficiency when maneuvering the saw with power.*



**Transmission Lever**

### **Engaging the Transmission**

1. Place the speed control lever at *STOP*.
2. Start the engine.
3. Remove the transmission engagement lever from the *DISENGAGE* slot.
4. Push the lever up and place it into the *ENGAGE* slot.

### **Disengaging the Transmission**

1. Place the speed control lever at *STOP*.
2. Remove the transmission engagement lever from the *ENGAGE* slot.
3. Pull the lever down and place it into the *DISENGAGE* slot.

### **Speed Control Lever**

The speed control lever moves the saw forward and backward at up to 200 ft/min.

*Note: The engine must be running at half throttle or greater to move the saw using the speed control lever.*



**Speed Control Lever**

1. Slowly push the lever toward *FORWARD* to move the saw forward and release when at the desired traveling speed.
2. Slowly pull the lever toward *REVERSE* to move the saw backward and release when at the desired traveling speed.
3. Place the lever at *STOP* to stop the saw. **DO NOT** assume at any time that the *STOP* position will act as a brake.

*Note: Always start the engine with the speed control lever at STOP.*

### **Water Supply**

The water supply cools the blade and minimizes dust when cutting. There are two blade guard hose connections on the saw, one on the right side and one on the left. These connections have water cutout valves to start and stop the flow of water to the blades. The left side also has the water source hose connection upstream of the water cutout valve.

*Note: Always test the water supply for adequate pressure and flow prior to cutting.*

### **Using the Water Supply**

1. Connect the water source hose to the water source hose connection on the left side of the saw.
2. Connect blade guard water hose to the water valve fitting on the left side of the saw, or to the single water valve fitting on the right side of the saw depending on the side being used for cutting.



**Water Valve on Left Side of Saw with Water Source Connection**

3. Connect the other end of the water supply hose to the blade guard.
4. Begin the flow of water from the source to the saw.
5. Just before cutting, open the water valve lever to begin water flow to the blade.

6. Increase and decrease the water flow while cutting using the water valve lever on the valve connected to the water supply hose.
7. Shut the water valve lever and disconnect the water source hose from the saw when finished.
8. Disconnect the water supply hose from the blade guard and water valve fitting as necessary.

### **Water Pressure Switch (Optional)**

The water pressure switch will shut the engine off if a low water pressure condition exists. Once water is supplied to the saw, turn the water pressure switch to *ON*. The switch is located on the switch plate on the right side of the instrument panel. When the cutting is complete, turn the pressure switch to *OFF* before shutting the water from the water source.

### **Water Pump (Optional)**

The water pump directs cooling water to the blade and minimizes dust when cutting.

1. Ensure all water supply lines are connected.
2. Ensure that the water valve located on the control panel is in the *OFF* position.
3. Turn on the water pump switch to start the pump. **DO NOT** start the water pump until just before cutting. **DO NOT** leave the water pump on when the cutting task is complete to avoid draining the battery.
4. Push the water valve to the *ON* position. The water will not flow to the blade until the blade is zeroed and lowered into the cut.
5. When cutting is complete, move the water valve to the *OFF* position.
6. Turn off the water pump switch *OFF* to stop the pump.

### **Cutting Guides**

Use the cutting guides as needed to help follow the cutting line. Always check the cutting guides for proper alignment with the blade prior to cutting.

### **Adjusting the Front Pointer**

1. Remove the lanyard from the cable cleat.
2. Lower the front pointer frame to the ground.
3. Loosen the appropriate front pointer frame screw.
4. Divide an 8–10 foot piece of string in half.
5. Place the looped end of string into a gullet on the backside of the blade.
6. Place one string line up against the backside of the blade and one string line up against the front side of the blade. Holding the string ends in one hand, tension the lines out toward the front pointer rod.

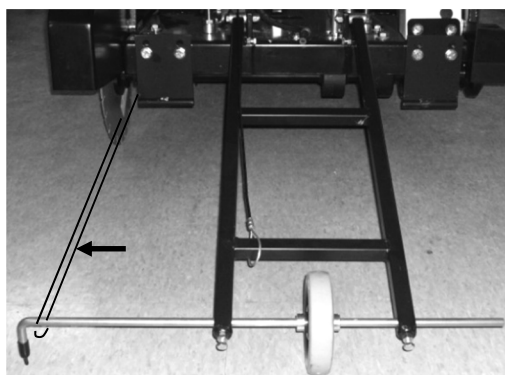

**Tensioned String Line**

7. Adjust the pointer rod to place the tip between the tensioned string lines.
8. Retighten the front pointer frame screw.
9. Lift the frame off the ground when finished.
10. Tension the lanyard and secure it to the cable cleat.

### **Adjusting the Rear Pointer(s)**

1. Loosen the appropriate rear pointer screw.
2. Adjust the orientation of the rear pointer and retighten the screw to secure.

### **Concrete Cutting**



**WARNING**



- **DO NOT** expose yourself or anyone else to the direct line of the blade when operating the saw.
- The direct work area should not contain buried or embedded electrical, gas, or water lines that could be damaged and/or cause personal injury while cutting.

*Note: Always raise the blade to provide proper clearance between the blade and the ground when maneuvering the saw.*

## **Helpful Hints Prior to Cutting**

Keep the following in mind for better efficiency while cutting:

- Use just enough handle pressure to guide the saw down the cutting line. **DO NOT** forcibly direct (twist) the saw from side to side when cutting. **DO NOT** jam, cock, or wedge the blade in a cut.
- Moving too quickly when cutting may stall the saw or may cause the blade to climb out from the cut. If the saw stalls while cutting, put the saw in **STOP** and raise the blade from the cut to restart the engine.
- Avoid sawing excessively deep to preserve the blade and reduce sawing costs.
- **DO NOT** lower the blade too quickly or move the saw forward too quickly when finishing a partial cut to avoid forcing the blade into the concrete.
- Always have a proper water flow when cutting for maximum blade efficiency. Using too much water when cutting will make the slurry look clear. Not using enough water will make the slurry look thick and pasty.
- Refer to the Diamond Products' Guide for Professional Concrete Cutters for additional cutting tips and information.

## **Tasks Prior to Cutting**

Complete the following tasks prior to cutting:

- Align the cutting guide(s) with the blade.
- Clearly mark the cutting line.
- Turn off all electricity, gas, and water around the direct work area.

## **Making a Cut**

1. Align the blade and cutting guide(s) with the cutting line.
2. Turn on the water and adjust the water flow.
3. Turn on the *Water Pressure* switch (Optional).
4. Turn on the *Water Pump* switch if needed.
5. Lower the blade to just above the cutting surface and set the cutting depth indicator at zero.



**Cutting Depth Indicator**

6. Slowly lower the blade into the concrete surface to a depth of two inches for the initial cut. Make the two-inch deep pass across the entire cutting line using the most efficient blade speed and traveling speed. **DO NOT** cut to the maximum depth in one pass.

*Note: Always use the step-cut method when cutting for maximum efficiency. For example, when cutting to a depth of ten inches, begin with a two-inch deep pass, then a four-inch deep pass, and finish with another four-inch deep pass to complete the cut.*

7. Raise the blade out of the cut and reposition the saw at the end of the cut. **DO NOT** move backwards in a previous cut.
8. Starting at the end of the cut, lower the blade back into the cut and make another two-inch deep pass or a deeper pass across the entire cutting line.

*Note: When not using the depth stop, pay attention to the cutting depth indicator at all times when lowering the blade back into the cut or when making a new cut, as the blade will not automatically stop at the desired depth.*

9. Raise the blade out of the cut, reposition the saw, and continue the step-cut process to reach the maximum depth. **DO NOT** cut any deeper than required.

### **Making a Cut Using the Blade Depth Stop**

1. Align the blade and cutting guide(s) with the cutting line.
2. Turn on the water and adjust the water flow.
3. Turn on the *Water Pressure* switch (Optional).
4. Turn on the *Water Pump* switch if needed.
5. Lower the blade to just above the cutting surface and set the cutting depth indicator at zero.
6. Slowly lower the blade into the concrete surface to a depth of two inches for the initial cut.
7. Turn the *Blade Depth Stop* knob clockwise until resistance is felt, which means the cutting depth is set.

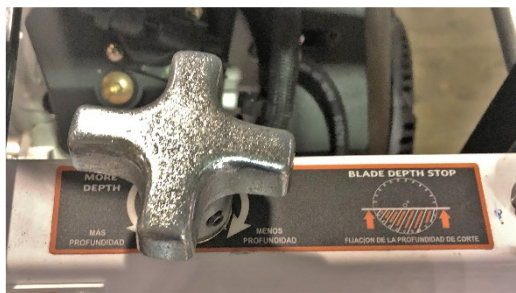

**Blade Depth Stop**

8. Make the two-inch deep pass across the entire cutting line using the most efficient blade speed and traveling speed. **DO NOT** cut to the maximum depth in one pass.

*Note: Always use the step-cut method when cutting for maximum efficiency. For example, when cutting to a depth of ten inches, begin with a two-inch deep pass, then a four-inch deep pass, and finish with another four-inch deep pass to complete the cut.*

9. Raise the blade out of the cut and reposition the saw at the end of the cut. **DO NOT** move backwards in a previous cut.
10. Turn the *Blade Depth Stop* knob counterclockwise to increase the cutting depth.
11. Starting at the end of the cut, lower the blade back into the cut to the desired depth and turn the *Blade Depth Stop* knob clockwise until resistance is felt.

12. Make another pass across the entire cutting line.
13. Continue the step-cut process using the *Blade Depth Stop* to reach the maximum depth. **DO NOT** cut any deeper than required.

### **Continuing a Partial-Cut**

1. Maneuver the saw to the desired location.
2. Align the blade with the previous cut and slowly lower the blade back into the concrete. Use extreme caution to make sure the blade is perfectly aligned within the cut. **DO NOT** continue cutting until the blade is aligned within the cut!
3. Continue the step-cut process (using the *Blade Depth Stop* if preferred) to reach the maximum depth. **DO NOT** cut any deeper than required.

### **Finishing a Cut**

1. Place the speed control lever at STOP.
2. Raise the blade from the cut (provide proper ground clearance).
3. Turn off the *Water Pump* switch and *Water Pressure* switch.
4. Turn off the water supply.

### **Parking Brake (Optional)**

The parking brake keeps the saw from moving forward or backward unintentionally and is generally used on steeper slopes and hills.

### **Engaging the Parking Brake**

Slide the brake lever over and out of the DISENGAGE slot and down into the ENGAGE slot.

### **Disengaging the Parking Brake**

Slide the brake lever over and out of the ENGAGE slot and up into the DISENGAGE slot.



## **Maintenance**

### **General**

Failure to read and comply with the maintenance instructions provided in this manual prior to performing maintenance may result in serious injuries and/or death, and may harm the saw. DO NOT attempt to perform maintenance on the saw if you are not properly trained for it, or are not supervised by an experienced person.

Refer to the CC3500J Parts List for additional information and part diagrams when performing maintenance tasks. Refer to the engine manufacturer as the primary source for all safety, operations, and maintenance instructions for the engine. Contact the saw and/or engine manufacturer with any additional questions.

Remove all necessary guards and access panels prior to servicing the saw. Replace prior to operating.

### **Pre Maintenance Preparations**

- Ensure the saw is in a safe area to conduct maintenance.
- Maintain proper cleanliness of the work area to minimize personnel injury or equipment damage.
- Ensure the saw is sufficiently cool to conduct any maintenance.
- Remove the cutting blade prior to starting any maintenance.
- Ensure there is adequate lighting in the work area to ensure safety.
- Ensure all equipment and tools required for the maintenance task are staged and available for use.
- Prior to any maintenance being performed, know the locations of all safety equipment such as fire extinguishers, first aid kits, etc.
- All maintenance shall be performed by qualified personnel only.

### **Rear Cover Screen**

The rear cover screen is a versatile component in regards to maintenance of the machine. It can be removed to gain access to components within the upright assembly.

### **General Cleaning**

The saw must be cleaned after each use and prior to conducting any maintenance. Ensure that the saw is cool prior to cleaning. Ensure affected electrical equipment is properly covered or de-energized prior to cleaning with water or air.

### **Cleaning Techniques**

Various cleaning options can be utilized depending on the type of cleaning required. High pressure washers and a mild detergent will work the best. Compressed air and low pressure water can also be utilized where required.



### **CAUTION**

Care must be taken when using high pressure water and compressed air to conduct any maintenance or cleaning. High pressure water and compressed air can cause injury to personnel or damage to equipment if not used properly.

### **Engine**

Use a mild detergent and water to clean the engine. Do not to spray water forcefully on the engine to prevent damage to components.

### Part Lubrication

 **WARNING**  
DO NOT grease parts with the engine running.



Lubricate all necessary parts on schedule for maximum saw efficiency. Occasionally lubricate controls, cables, hinges, latches, and linkages with a spray lubricant when movement becomes stiff and/or sluggish. Use one to two full pumps of NLGI No. 2 premium, lithium-based grease when lubricating all grease fittings.

*NOTE: Use more grease on bearing grease fittings if they are too hot to touch after completing work.*

### Post Cleaning

- Lubricate the machine as required.
- Dry all electrical components using compressed air.
- Do not start the machine until it has had time to thoroughly dry.

## MAINTENANCE

### Service Schedule

The service schedule is based primarily on the standard operating time of the machine. The frequency of the maintenance tasks can be increased based on the working environments of the machine.

Task	Cycle				
	Daily	100 Hrs.	150 Hrs.	300 Hrs.	Yearly
Visually inspect saw for damage and repair as necessary	X				
Wipe down and clean all components for dust, debris, and slurry	X				
Check that all safety guards are in place and in good operating condition	X				
Inspect vthe skid plates for damage and clean, repair or replace as necessary	X				
Check for loose or frayed wiring. Repair or replace as necessary.	X				
Check for loose nuts and bolts and retighten	X				
Check engine oil level	X				
Check fuel level	X				
Check hydraulic fluid level	X				
Lubricate blade shaft bearings (End of work day)	X				
Inspect all belts for tension or wear and re-tension or replace as necessary	X <sup>1</sup>				
Lubricate the jackshaft bearings		X <sup>2</sup>			
Lubricate front axle bearings		X <sup>2</sup>			
Lubricate rear axle bearings		X <sup>2</sup>			
Lubricate transmission jackshaft bearings		X <sup>2</sup>			
Lubricate linkage assembly bearings		X <sup>2</sup>			
Lubricate front wheel bearings		X <sup>2</sup>			
Replace engine oil and filter		X			
Clean air filter			X <sup>2</sup>		
Replace fuel filter			X		
Replace air filter				X <sup>3</sup>	
Replace spark plug					X

1 - Initially inspect the belt after the first four hours of operation and then daily.

2 - Service more often as required.

3 - Or 1 year whichever occurs first.

## Daily Service

### **Check Engine Oil Level**

Prior to checking the engine oil level, ensure that there is no blade installed on the saw and the saw frame that is in a level position.

1. Remove the engine oil dipstick from the right side of the engine.



**Engine Oil Dipstick**

2. Check the oil level on the dipstick. The level should be between the Full and Low marks in the knurled section.



**Engine Oil Level Indicators**

3. If the level is low, remove the engine oil fill cap located on the front of the engine.



**Engine Oil Fill Cap**

4. Add oil until the level is correct.
5. Replace the engine oil fill cap.

### **Check Fuel Level**

Prior to checking the fuel level, ensure that there is no blade installed on the saw and that the saw frame is in a level position.

1. Visually check the fuel level from the fuel filler cap located on the left side of the control panel.
2. If fuel level is low, remove the fuel tank fill cap.



**Fuel Tank Fill Cap**

3. Fill the tank with unleaded fuel only.

*Note: Lower ethanol fuel is strongly recommended, particularly for summer months.*

### **Hydraulic System**

#### **! WARNING**

- Always place a piece of cardboard or paper up against hydraulic components, or use a leak detection fluid to check for hydraulic fluid leaks. Keep all body parts away from leaks and/or areas that may eject hydraulic fluid. Pressurized hydraulic fluid can penetrate the skin, causing serious injuries. Seek medical attention immediately!
- Always make sure any hydraulic components being serviced are not supporting the weight of other saw components. If a particular component is under pressure when connections points are loosened, oil may spray out forcefully.



## MAINTENANCE

Inspect all hydraulic hoses and fittings daily for leaks. Remember to use cardboard or a piece of paper when checking for leaks and replace damaged components immediately.

### **Adding Fluid to the Hydraulic Lift Pump**

Check the fluid daily and add fluid to the pump as necessary.

1. Lower the saw to level the frame.
2. Remove the hydraulic pump cover plate.



Hydraulic Pump Cover Plate

3. Remove the hydraulic pump breather cap.



Hydraulic Lift Pump Breather Cap

4. Using a funnel add Dexron 3 automatic transmission fluid or equivalent to just below where the fill port extends into the hydraulic pump. Do not overfill, as this will cause oil leakage through the breather cap when raising the saw.
5. Replace the breather cap and retighten to secure.
6. Replace the hydraulic pump cover plate.

### **Lubricate the Blade Shaft Bearings**

At the end of each work day, lubricate the two front blade shaft bearings.

1. Locate the right and left blade shaft bearing grease fittings located on the bearing lubrication manifold located at the front of the saw.

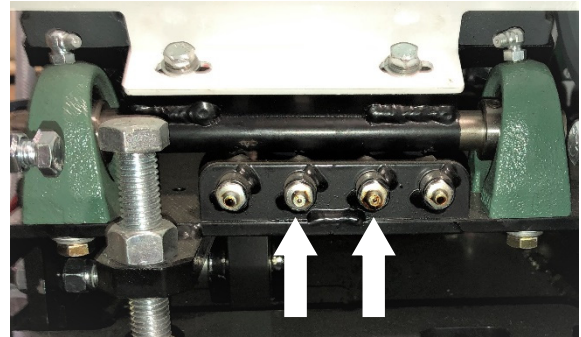

Right and Left Blade Shaft Bearing Grease Fittings

2. Add no more than two pumps of bearing grease into each of the two blade shaft bearing grease fittings.

### **Belt System**

#### **! WARNING**



- Turn the engine off prior to servicing the belts
- Use extreme caution when working with belts and rotating machine parts to avoid entanglement.

#### **! CAUTION**

Let the belts cool down prior to servicing them.

Inspect all belts daily for fraying, stress cracks, and/or breakage and replace immediately when damaged. Always re-tension new belts after the first four hours of use. **DO NOT** exceed the manufacturer's recommended belt tension settings when tensioning belts.

*Note: Over-tensioning belts may damage the crankshaft. Under-tensioning belts may cause slippage, shorter belt life, and/or poor saw performance. Squealing belts indicate looseness.*

### Tensioning the Drive Belts

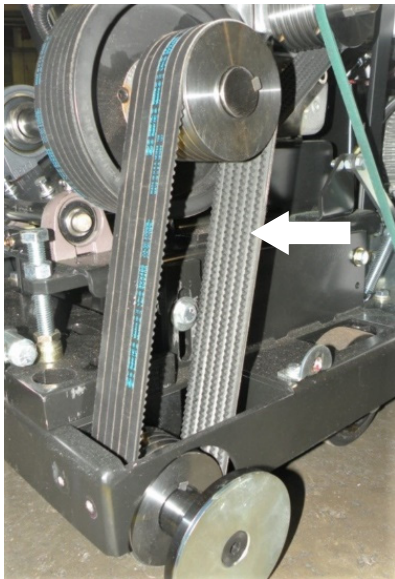

**Blade Shaft Drive Belts**

1. Test the belt tension. Refer to the belt manufacturer for additional information on belt tension settings.
2. Loosen the four engine mount bolts.

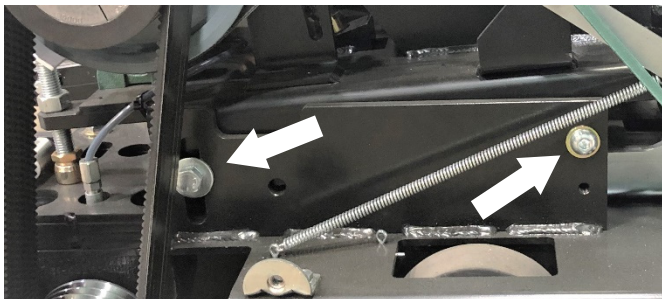

**Engine Mount Bolts (Left Side)**

3. Loosen the nut on both blade drive belt tension bolts.

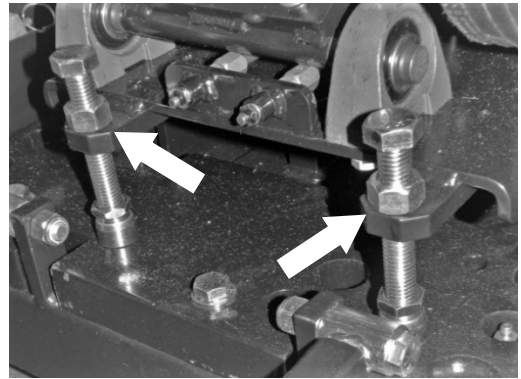

**Blade Shaft Drive Belts Tension Bolts and Nuts**

4. Turn both blade drive belt tension bolts (large threaded bolts on engine base) clockwise to tighten the belts.
5. Test the belt tension and readjust the bolts as necessary.
6. Tighten the nut on both blade drive belt tension bolts.
7. Retighten the four engine mount bolts.

### Tensioning the Jackshaft Belts

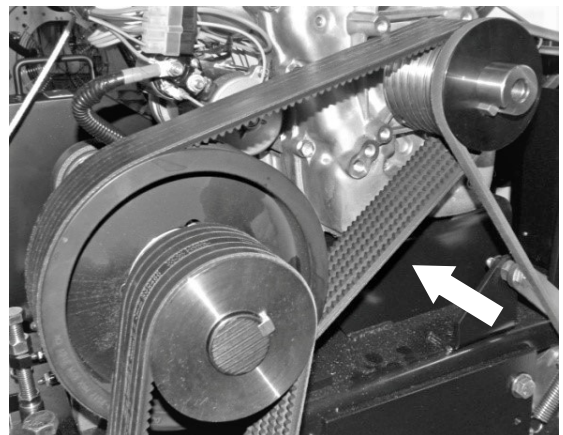

**Jackshaft Drive Belts**

1. Test the belt tension. Refer to the belt manufacturer for additional information on belt tension settings.
2. Loosen the four engine mount bolts.

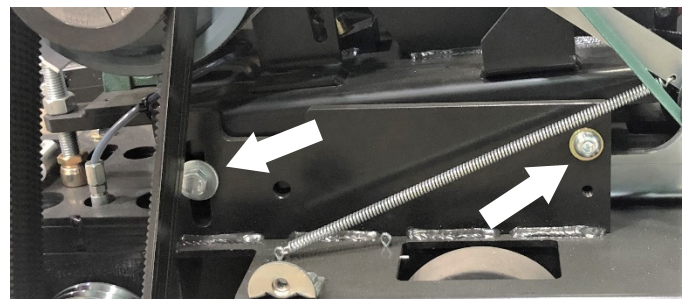

**Engine Mount Bolts (Left Side)**

3. Loosen the blade drive belts by loosening the nut on both drive belt tension bolts and turning the tension bolts counterclockwise.
4. Loosen the two jackshaft mount bolts.

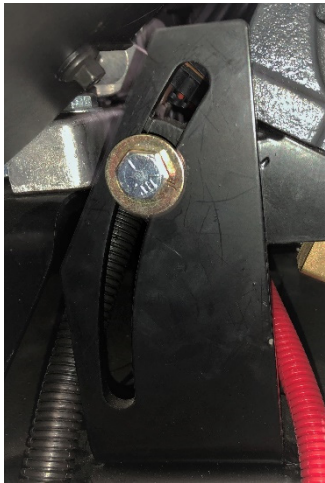

**Jackshaft Mount Bolt (Right Side)**

5. Loosen the nut on the jackshaft belt tension bolt.

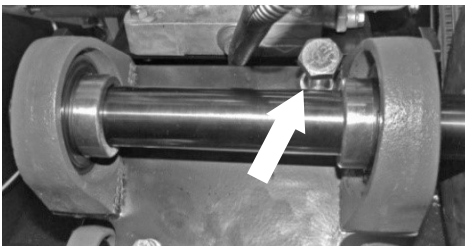

**Jackshaft Drive Belts Tension Bolt**

6. Turn the jackshaft belt tension bolt (large threaded bolt on jackshaft mount) clockwise to tighten the belts.
7. Test the belt tension and readjust the bolt as necessary.
8. Tighten the nut on the jackshaft belt tension bolt.
9. Retighten the two jackshaft mount bolts.
10. Re tension the drive belts by turning the drive belt tension bolts clockwise.
11. Test the belt tension and readjust the bolts as necessary.
12. Tighten the nut on both blade drive belt tension bolts.
13. Retighten the four engine mount bolts.

## **100 Hour Service**

### **Bearing Lubrication**

#### **Lubricate the Jackshaft Bearings**

There are four jackshaft bearings that need lubrication. Two main jackshaft bearings and two jackshaft pivot bearings.

*To lubricate the two main jackshaft bearings:*

1. Locate the right and left main jackshaft bearing grease fittings located on the bearing lubrication manifold located at the front of the saw.

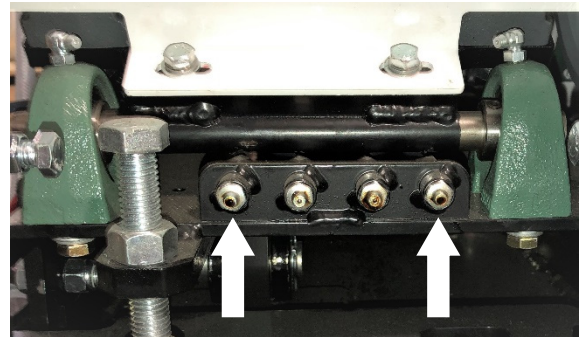

**Right and Left Main Jackshaft Bearing Grease Fittings**

2. Add no more than two pumps of bearing grease into each of the two main jackshaft bearing grease fittings.

*To lubricate the two jackshaft pivot bearings:*

1. Locate the right and left jackshaft pivot bearing grease fittings.

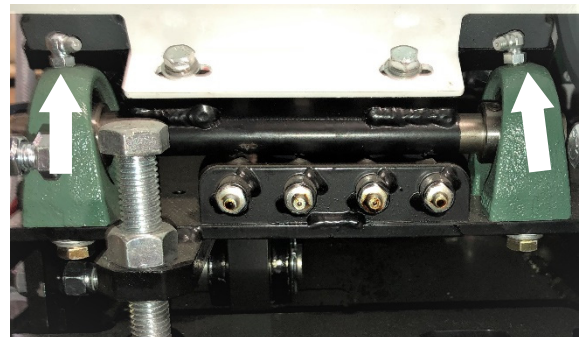

**Right and Left Jackshaft Pivot Bearing Grease Fittings**

2. Add no more than two pumps of bearing grease into each of the two jackshaft pivot bearing grease fittings.

**Lubricate the Front Axle Bearings**

1. Raise the saw to the full up position.

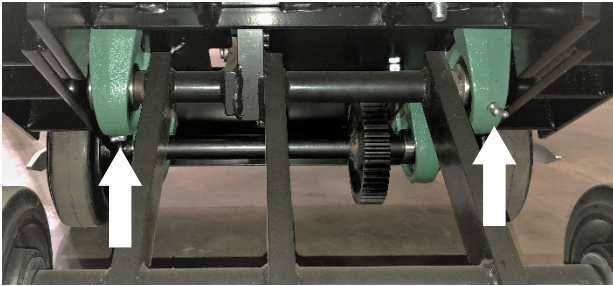

**Right and Left Front Axle Bearing Grease Fittings**

2. Add no more than two pumps of grease to each of the two front axle bearings grease fittings located under the frame base on both the left and right side.

**Lubricate the Rear Axle Bearings**

1. Lower the saw to the full down position.



**Right and Left Rear Axle Bearing Grease Fittings**

2. Add no more than two pumps of grease to each of the two rear axle bearings grease fittings located under the frame base on both the left and right side.

**Lubricate the Transmission Jackshaft Bearings**

1. Using a 3/8" socket remove the rear cover screen from the back of the upright assembly.
2. Using a 7/16" socket remove the gear guard from the transmission platform weldment.

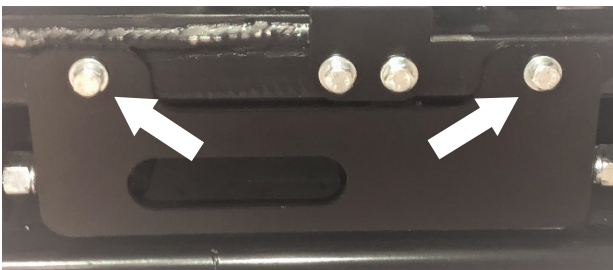

**Gear Guard**

3. Locate the two transmission jackshaft bearing fittings and add no more than two pumps of grease to each of the bearings grease fittings.

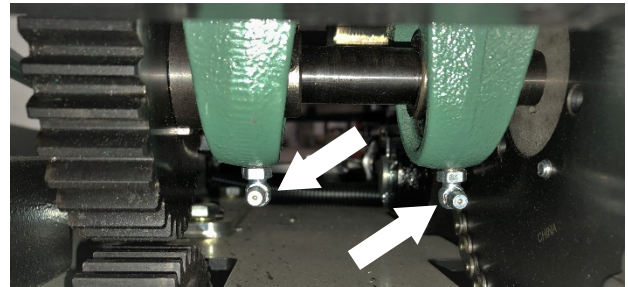

4. Reinstall the gear guard and tighten the 1/4"-20 bolts to secure.
5. Reinstall the rear cover screen and tighten the 1/4"-20 bolts to secure.

**Lubricate the Linkage Assembly**

The linkage assembly is a part of the rear drive assembly. There are three linkages that contain two rod ends each that must be lubricated. Two of the linkages can be accessed from the back of the saw and the third can be accessed from the right side of the saw.

1. Using a 3/8" socket remove the rear cover screen from the back of the upright assembly.
2. Locate the 10-1/2" linkage running parallel to the frame base and add no more than one pump of grease into each of the two rod ends.

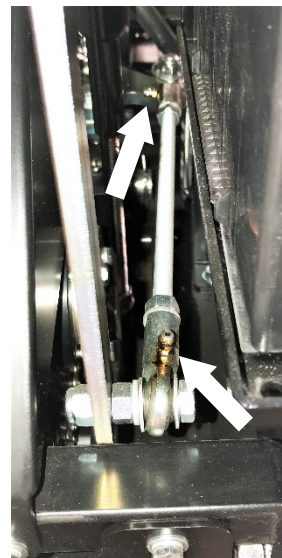

**Rear Drive Linkage, 10-1/2"**



3. Locate the 7-3/4" linkage that connects the control lever assembly to the rear drive assembly and add no more than one pump of grease to each of the two rod ends.

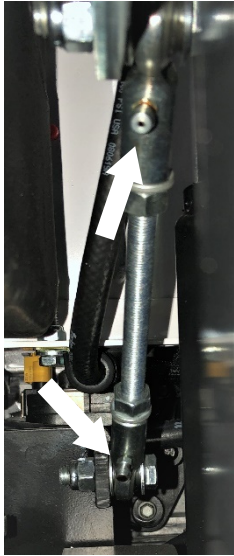

Control Lever Linkage

4. From the left side of the saw just behind the engine, locate the 7-3/4" linkage running parallel to the frame base and add no more than one pump of grease to each of the two rod ends.



Rear Drive Linkage, 7-3/4"

5. Reinstall the rear cover screen and tighten the 1/4"-20 bolts to secure.

### ***Lubricate the Front Wheels***

1. Raise the saw to the full up position.
2. Locate the grease fitting on the outside of each front axle wheel and add no more than two pumps of grease to the wheel bearings.



Front Wheel Grease Fitting

### ***Replace Engine Oil and Filter***

- Refer to the engine operator's manual for oil specifications and capacities.
  - Refer to the engine operator's manual for oil filter specifications.
  - Ensure the engine is turned off and sufficiently cooled down prior to draining the engine oil.
1. Ensure the saw does not have a blade attached and is level to the ground.
  2. Place a drain pan beneath the drain hose located on the right side of the saw.



Oil Drain Hose

3. Remove and wipe clean the engine oil dipstick and set aside.

4. Remove the 1/4" pipe plug from the end of the drain hose and allow the oil to drain completely.
5. Remove the oil filter located on the right side of the engine.
6. Wipe the filter head area clean with a lint free cloth.
7. Fill the new filter with oil and allow two minutes for the oil to be absorbed by the filter material.
8. Apply a thin film of oil to the rubber gasket of the new filter.
9. Install the new filter and hand tighten to secure.
10. Remove the oil fill cap from the front of the engine.
11. Fill the engine crankcase with oil in accordance with the engine manufacturer's specifications and capacities.
12. Replace the oil fill cap and reinstall the engine dipstick.
13. Start the engine and check for leaks. Stop the engine, correct the leaks and recheck the oil level using the dipstick.
14. Dispose of the used oil and filter in accordance with city, state and federal regulations.

### **150 Hour Service**

#### ***Clean the Air Cleaner Filter Element***



#### **WARNING**

DO NOT operate the saw without the air filter installed.

1. Unhook the retaining clips and remove the end caps.



**Air Filter Assembly**

2. Check and clean the inlet screen.



**Air Filter Inlet Screen**

3. Pull the outer filter element out of the cleaner and inspect for damages. Replace as necessary. To protect the engine, DO NOT pull out the inner filter element.



**Outer Filter Element**

4. Move away from the saw and clean the filter from the inside out. Use dry compressed air to clean the filter (a maximum of 30 psi or 2.1 bar) and rotate it while cleaning.
5. Inspect the inside of the cleaner housing and end caps for debris, and wipe clean using a damp lint free cloth as necessary. DO NOT use compressed air to blow out the inside of the air cleaner housing. DO NOT allow dust to enter the air intake tube when cleaning or replacing parts.
6. Place the outer filter element back into the housing (over the inner filter element) and gently push the element into the unit until it feels secure.
7. Reinstall the end caps and secure the clips.

## Replace the Fuel Filter

1. Lower the saw completely.
2. Close the fuel shutoff valve.
3. Place a drain pan under the hoses and in-line filter.
4. Remove the hose clamp from both sides of the filter.



**Fuel Filter**

5. Remove the filter from the hoses. Drain any escaping fuel and dispose of the used fuel and filter according to city, state, and federal regulations.
6. Place the fuel hose coming from the fuel tank onto the end of the filter (the arrow on the filter should not point toward this hose). Push the hose tightly up against the edge of the filter and secure with the hose clamp.
7. Place the fuel hose coming from the engine onto the other end of the filter (the arrow on the filter should point toward this hose). Push the hose tightly up against the edge of the filter and secure with the hose clamp.
8. Open the fuel shutoff valve.

## 300 Hour Service

### Replace the Air Cleaner Filter Elements



#### **WARNING**

DO NOT operate the saw without the air filter installed.

1. Unhook the retaining clips and remove the end caps.



**Air Filter Assembly**

2. Check and clean the inlet screen.



**Air Filter Inlet Screen**

3. Pull the outer filter element and inner filter element out of the cleaner.

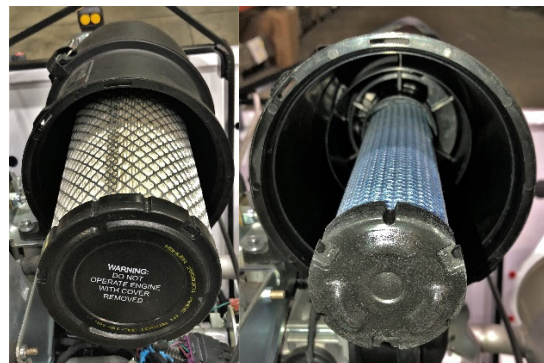

**Outer and Inner Filter Elements**

4. Inspect the inside of the cleaner housing and end caps for debris, and wipe clean using a damp lint free cloth as necessary. DO NOT use compressed air to blow out the inside of the air cleaner housing. DO NOT allow dust to enter the air intake tube when cleaning or replacing parts.
5. Place the inner filter element back into the housing and gently push the element into the unit until it feels secure.
6. Place the outer filter element back into the housing (over the inner filter element) and gently push the element into the unit until it feels secure.
7. Reinstall the end caps and secure the clips.

## Yearly Service

### **Replace and Gap Spark Plugs**

There are two spark plugs associated with the engine. One in the front of the saw directly below the oil fill cap, and one directly opposite of the first between the engine and the upright assembly.

- Refer to the engine operator's manual for all spark plug specifications.
  - Ensure the engine is turned off and sufficiently cooled down prior to replacing the spark plugs.
1. Pull the spark plug wire (with a metal cap) away from the spark plug.



**Spark Plug Wire with Metal Cap**

2. Remove the spark plug using a 5/8" spark plug socket.



**Spark Plug**

3. Gap the new spark plug in accordance with the engine manufacturer's specifications.
4. Install the new plug and torque it in accordance with the engine manufacturer's specifications.

5. Reinstall the plug wire ensuring that it is fully seated onto the plug.
6. Repeat steps 1 through 5 for the second plug.

## **Regular Maintenance**

### **Drive Alignment**

Adjust the rear axle when the saw's drive alignment is off (saw will not cut in a straight line). *Note: The rear axle can be adjusted based on preference.*

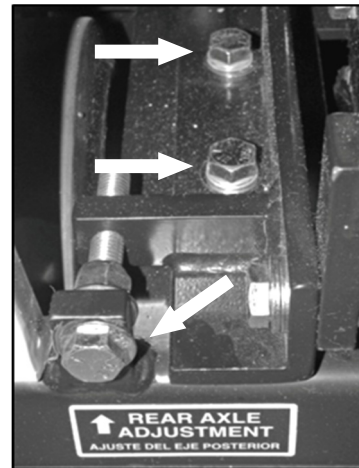

**Rear Axle Bearing Bolts and Adjustment Bolt**

1. Loosen the two left rear axle bearing screws.
2. Loosen the hex nut on the rear axle adjustment bolt.
3. Turn the adjustment bolt clockwise to adjust the drive alignment toward the left, or counterclockwise to adjust the drive alignment toward the right.
4. Retighten the hex nut on the adjustment bolt.
5. Retighten the two left rear axle bearing screws.

## **Wheels**



### **WARNING**

Raise the saw to a proper height for access when working underneath the saw. Use chocks to block the wheels, and fit blocks or jacks under the frame edges at the front and back of the frame for additional support.



### Replacing the Front Wheels

Replace the front wheels when damaged and/or affecting saw performance.

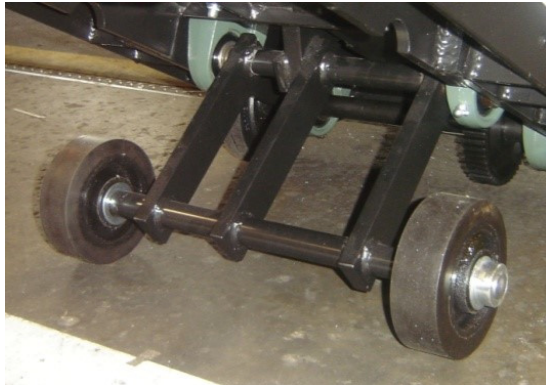

**Front Wheels**

1. Move the saw to level ground. Use a jack to lift the front wheels off the ground.
2. Remove the setscrew from the set collar and remove the set collar.
3. Remove the wheel and flat washers from the front axle.
4. Place a flat washer and then a new wheel onto the front axle.
5. Place a flat washer and then the set collar up against the wheel on the front axle.
6. Retighten the setscrew into the set collar to secure.
7. Repeat steps 2 through 6 for the second front wheel.
8. Remove the jack stand(s) and slowly lower the saw until the wheels are firmly touching the ground.

### Replacing the Rear Wheels

Replace the rear wheels when damaged and/or affecting saw performance.

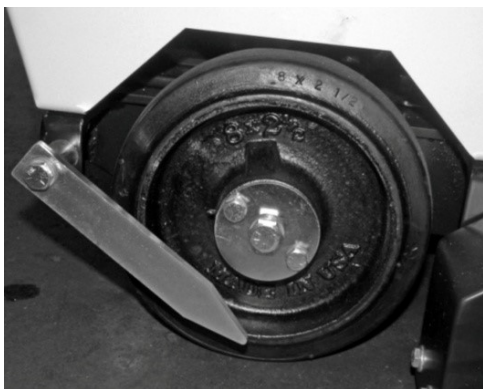



**Rear Wheel**

1. Move the saw to level ground. Use a jack to lift the rear wheels off the ground.

2. Remove the three screws from the wheel.
3. Remove the wheel mount washer and wheel from the rear axle.
4. Place a new wheel onto the rear axle.
5. Replace the wheel mount washer and retighten the three screws to secure the wheel.
6. Repeat steps 2 through 5 for the second rear wheel.
7. Remove the jack stand(s) and slowly lower the saw until the wheels are firmly touching the ground.

### Battery

#### **WARNING**

- Ignitable explosive gases are emitted from the battery. **DO NOT** expose the battery to sparks or open flames, and keep the area around the battery well-ventilated. 
- Disconnect the battery prior to servicing the saw (unless stated otherwise).
- Always keep the battery cable clamps away from the battery terminals when the battery is disconnected to avoid accidental connections while servicing. 
- Always be sure to connect the battery cables to the proper terminal when reconnecting.

#### **CAUTION**

- Use a proper battery tester when testing the battery strength.
- Use protective eyewear or a face shield and avoid contact with the skin when handling/servicing the battery.

The saw contains a charged battery with one positive cable lead and one negative cable lead. To power the hydraulic lift pump. The battery can be accessed by removing the rear cover screen.



**Battery**

### **Battery Type**

12 Volt, Group 34

### **Servicing the Battery**

1. Disconnect the negative cable lead from the negative terminal.

*NOTE: Always disconnect the negative cable first.*

2. Disconnect the positive cable lead from the positive terminal.
3. Unsecure the battery from the hold-down bracket by removing the two lock nuts from the battery hold-down tie rods and lift the hold-down bracket off.
4. Carefully remove the battery from the battery tray.
5. When replacing the battery, carefully place a new battery into the battery tray. Bring the old battery to a recycling facility; many battery retailers also accept old batteries.
6. When cleaning the battery, inspect the terminals, clamps, and cables for damages and corrosion. Clean the terminals and clamps using a wire brush, or use another approved technique for cleaning. Use acid-free, acid-resistant grease to grease the battery clamps and terminals. Carefully place the battery back into the battery.
7. Reconnect the positive cable lead to the positive battery terminal.

*NOTE: Always reconnect the positive cable first.*

8. Reconnect the negative cable lead to the negative battery terminal.

9. Re-secure the battery to the hold down top brace by reinstalling the lock nuts onto the two tie rod bolts and tighten them to secure.

### **Speed Control Lever**

#### **Adjusting the Speed Control Lever Linkage**

Adjust the speed control lever linkage when it is set incorrectly; for example, when the saw is in neutral, but the lever is closer to the forward or reverse position.

1. Start the engine and move the speed control lever forward or backward to find the neutral position.

*Note: The saw should not move at all.*

2. Stop the engine.
3. Disconnect the 10-1/2" linkage from the bell crank. (See "Rear Drive Assembly" in the CC3500J Parts List)

*Note: DO NOT move the 7-3/4" when disconnecting the 10-1/2" linkage to keep the saw in the neutral position. (See "Rear Drive Assembly" in the CC3500J Parts List)*

4. Loosen the threaded rod nuts on the 10-1/2" linkage.
5. Turn the threaded rod to either lengthen or shorten the linkage, which will move the speed control lever toward the neutral position on the control panel.
6. When the speed control lever is in the neutral position on the control panel, retighten the threaded rod nuts on the 10-1/2" linkage.
7. Reconnect the 10-1/2" linkage to the bell crank. DO NOT move the 7-3/4" linkage.
8. Remove all tools from the area. Start the engine to check the speed control lever for accuracy.
9. If the speed control lever is still not properly aligned, repeat step 1–8 to readjust.

#### **Adjusting the Speed Control Lever Friction**

Adjust the screw and nut on the speed control lever (through friction spacer) to change the amount of friction felt when moving the lever forward or backward. Loosen the bolt a small amount to make it easier to move the lever, or tighten the bolt a small amount to make it harder to move the lever.

**Shaft Tachometer Magnetic Sensor (Optional)**

The magnetic sensor transfers the blade speed to the blade shaft tachometer if installed. Adjust or replace the magnetic sensor if the tachometer reading remains at zero while operating the saw.

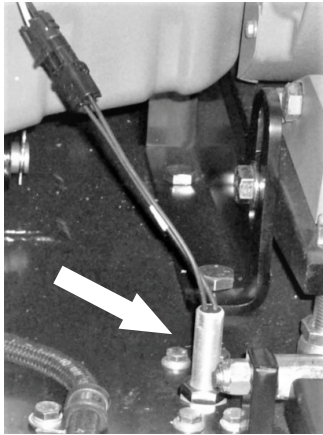

**Magnetic Sensor**

**Adjusting the Magnetic Sensor**

1. Loosen the jam nut on the magnetic sensor.
2. Turn the magnetic sensor clockwise to screw the sensor in until it bottoms out (stops).
3. Turn the sensor counterclockwise exactly one-half turn.
4. Retighten the jam nut down to the frame base to secure.
5. Test the tachometer and replace if it is still not working properly.

**Replacing the Magnetic Sensor**

1. Disconnect the battery.
2. Disconnect the tachometer sensor wire harness.
3. Loosen the jam nut on the magnetic sensor and turn the sensor counterclockwise to remove it.
4. Turn the new magnetic sensor's jam nut counterclockwise to place the nut near the top of the sensor.
5. Fit the sensor into the center of the shaft tachometer gear guard through the hole on the frame base.
6. Turn the magnetic sensor clockwise until it bottoms out (stops).
7. Turn the sensor counterclockwise exactly one-half turn.

8. Retighten the jam nut down to the frame base to secure.
9. Reconnect the tachometer sensor wire harness.
10. Reconnect the battery.
11. Test the tachometer and readjust as necessary.

**Transmission**

**Cooling Fan**

Wipe down or use compressed air to clean dust, debris, and slurry from the transmission cooling fan daily.

*Note: Failure to clean the cooling fan will not allow the transmission oil to cool properly.*

**Tightening the Rear Drive Chain**

Inspect the rear drive chain daily and tighten as necessary. Lubricate the chain every 40 hours with Mobil ATF D/M oil to reduce chain wear.

1. Loosen the nut on the four screws securing the transmission to the transmission platform.
2. Loosen the setscrew hex nut at the midpoint of the transmission platform.
3. Turn the setscrew clockwise to push the transmission forward in the platform slots. Leave a little bit of slack in the chain, and DO NOT over-tighten it.



**Transmission Setscrew**

4. Retighten the hex nut to secure the transmission setscrew.
5. Retighten the nut to the four screws to secure the transmission to the transmission platform.
6. Once the drive chain is tensioned, check the transmission belt for proper alignment and tension, and adjust as necessary.

**Belt Replacement**

**⚠️ WARNING**

- Turn the engine off prior to servicing the belts
- Use extreme caution when working with belts and rotating machine parts to avoid entanglement.



**⚠️ CAUTION**

Let the belts cool down prior to servicing them.

Inspect all belts daily for fraying, stress cracks, and/or breakage and replace immediately when damaged. Always re-tension new belts after the first four hours of use. **DO NOT** exceed the manufacturer's recommended belt tension settings when tensioning belts.

*Note: Over-tensioning belts may damage the crankshaft. Under-tensioning belts may cause slippage, shorter belt life, and/or poor saw performance. Squealing belts indicate looseness.*

**Replacing the Blade Drive Belts**

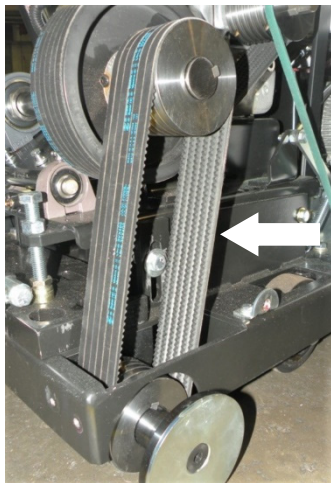

**Blade Shaft Drive Belts**

1. Loosen the four engine mount screws.

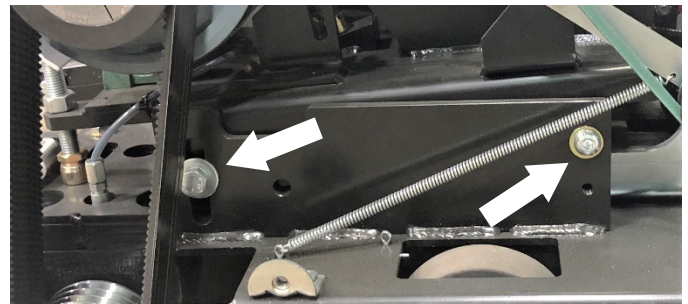

**Engine Mount Bolts (Left Side)**

2. Loosen the nut on both blade drive belt tension bolts.

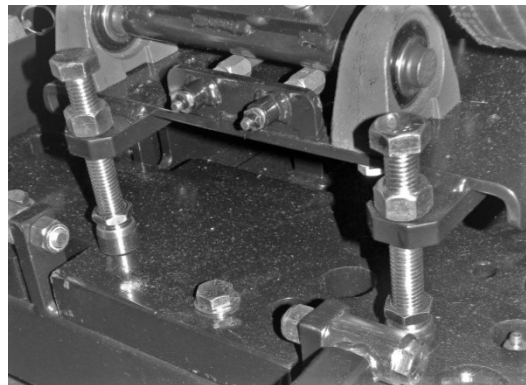

**Blade Shaft Drive Belts Tension Bolts and Nuts**

3. Turn both blade drive belt tension bolts (large threaded bolts on engine base) counterclockwise to loosen the belts.
4. Remove the matched set of belts from the blade shaft sheave and front jackshaft sheave.
5. Loop and align a new matched set of belts around the blade shaft sheave and front jackshaft sheave.
6. Turn both blade drive belt tension bolts (large threaded bolts on engine foot) clockwise equally to tighten the belts.
7. Test the belt tension and readjust the bolts as necessary. **DO NOT** exceed the manufacturer's tension settings.
8. Tighten the nut on both blade drive belt tension bolts.
9. Retighten the four engine mount screws.



**Replacing the Jackshaft Belts**

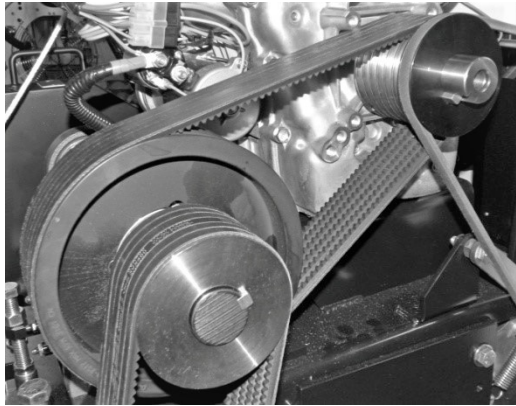

**Jackshaft Drive Belts**

1. Loosen the four engine mount screws and loosen the blade drive belts.

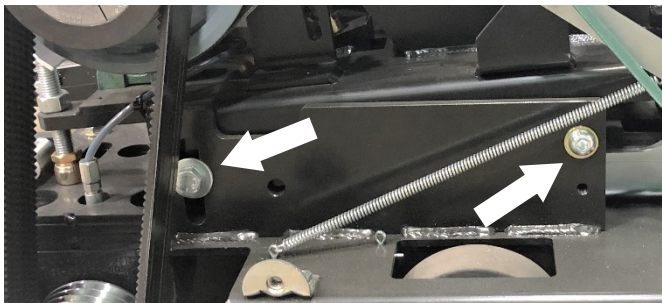

**Engine Mount Bolts (Left Side)**

2. Loosen the two jackshaft mount screws.
3. Lift up on the idler arm and remove the transmission drive belt.
4. Loosen the nut on both blade drive belt tension bolts.
5. Turn both blade drive belt tension bolts (large threaded bolts on engine base) counterclockwise to loosen the belts.
6. Remove the matched set of belts from the blade shaft sheave and front jackshaft sheave.
7. Loosen the nut on the jackshaft belt tension bolt.
8. Turn the jackshaft belt tension bolt (large threaded bolt on jackshaft mount) counterclockwise to loosen the belts.
9. Remove the matched set of belts from the rear jackshaft sheave and engine sheave.
10. Loop and align a new matched set of belts around the rear jackshaft sheave and engine sheave.
11. Turn the jackshaft belt tension bolt (large threaded bolt on jackshaft mount) clockwise to tighten the belts.

12. Test the belt tension and readjust the bolt as necessary. DO NOT exceed the manufacturer's tension settings.
13. Tighten the nut on the jackshaft belt tension bolt.
14. Retighten the two jackshaft mount screws.
15. Reinstall and tension the blade drive belts in accordance with the procedure found in the "Daily Maintenance" section of this manual.
16. Retighten the four engine mount screws.
17. Reinstall the transmission drive belt.

**Replacing the Transmission Drive Belt**

Replace the idler pulley spring when the transmission drive belt begins slipping during normal operation, or when the spring becomes overstretched, not allowing the belt to be fully tightened.

1. Lift up the idler arm and remove the transmission drive belt. Gently release the arm.
2. Loop and align a new belt around the engine sheave and transmission sheave.
3. Lift up the idler arm and loop the belt under the idler pulley. Gently release the arm to tension the belt.

**Belt Sheaves**

The belt sheaves may need to be changed when changing the blade size. Refer to the CC3500J Parts List for additional information.

*Note: All belts must be removed prior to changing the sheaves.*

**Changing the Small and Large Jackshaft Sheaves (14" through 26" Saws)**

1. Remove both setscrews from the front of the bushing.
2. Place one of the removed setscrews into the third setscrew hole (in line with slot) on the bushing. Using a 1/2" impact wrench, tighten the setscrew into the hole to separate the sheave from the bushing. If the sheave and bushing will not separate, wedge a flat-head screwdriver into the slot on the bushing and tap the other end of the screwdriver with a rubber mallet to separate the sheave and bushing.
3. Remove the sheave and bushing.
4. Remove the setscrew used to separate the sheave and bushing.

- Fit the appropriate size bushing and sheave together and slide them onto the jackshaft.

*Note: Align the bushing with the jackshaft key in place on the shaft prior to installing, or drive the key into the key hole once the sheave and bushing are fully installed.*

*Note: Ensure the sheaves are properly aligned prior to securing them. See “Aligning the Belt Sheaves” later in this section.*

- Place the two setscrews into the setscrew holes (in line with each other) on the bushing and retighten the setscrews to secure the bushing and sheave.

### **Changing the Small Jackshaft Sheave (30” Saw), Blade Shaft Sheave, Transmission Sheave, and Engine Sheave**

- Remove the four setscrews (two on transmission sheave) from the sheave grooves.
- Remove the sheave.

*Note: The transmission sheave must be removed prior to removing the engine sheave.*

- Align the appropriate size sheave with the drive key and fit the sheave onto the shaft.

*Note: If desired, drive the key into the key hole once the sheave is fully installed.*

*Note: Ensure the sheaves are properly aligned prior to securing them. See “Aligning the Belt Sheaves” later in this section.*

- Place the four setscrews (two on transmission sheave) into the setscrew holes in the sheave grooves, and retighten the setscrews to secure the sheave.

*Note: The engine sheave must be installed prior to installing the transmission sheave.*

### **Aligning the Belt Sheaves**

Always align the large jackshaft sheave with the engine sheave, and the small jackshaft sheave with the blade shaft sheave prior to securing the sheaves in place.

- Use a straightedge (use skinny side of straightedge for least amount of bending) and place it against the outside edge of one of the sheaves.

- Adjust either or both sheaves for alignment and secure in place.

### **Engine**



**WARNING**



Let the engine cool down prior to servicing the saw.  
**DO NOT** service the saw with the engine running (unless stated otherwise).

**Refer to the engine manual and manufacturer for a full engine maintenance schedule and additional engine maintenance information.**

### **Lifting**



**CAUTION**

Always use a strap to lift the machine. Ensure the strap is rated high enough to handle the load.

- Ensure the work area is clear of any obstructions and all personnel are at a safe distance prior to lifting the machine.
- Using a properly rated strap, place the strap around the frame lift using a basket style hitch.
- Slowly lift the machine only high enough to conduct the required work.

### **Transporting**

Always secure the machine using tie down straps to avoid damage during transport.

Never transport the saw with a blade attached.

*Note: Never tow the machine as this may cause damage to the drive components.*

### **Storing**

Complete the tasks listed below prior to storing the saw for longer time frames:

- Turn off all switches and controls.
- Remove blades.
- Lower the saw completely to remove strain on the lifting mechanism.
- Clean and wipe down the saw to remove dust, debris, and slurry from saw components.
- Remove the battery and store in a proper location, out of reach from children.

## MAINTENANCE

- Refer to the engine manual for all engine recommendations prior to storing.
- Store the saw in a dry area, protected from outdoor elements and out of reach from children.

### ***Disposal***

Dispose of the saw when it's no longer repairable, and/or contains safety hazards not

worth repairing or maintaining. Complete the tasks listed below when discontinuing usage:

- Remove the battery and bring to a recycling facility; many battery retailers also accept old batteries.
- Transport the saw to a salvage yard or recycling facility.

## REFERENCES

### Appendix A

#### **Troubleshooting**

<b>Troubleshooting</b>		
<b>Symptom</b>	<b>Problem</b>	<b>Solution</b>
1. Engine will not start.	Out of fuel?	Fill fuel tank.
	Emergency stop button down?	Pull up emergency stop button.
	Fuel lines clogged?	Unclog or replace fuel lines.
	Air in fuel lines?	Bleed fuel lines.
	Worn-out battery?	Charge or replace battery.
	Faulty battery connection?	Inspect, clean, and tighten battery cables.
	Engine malfunction?	Refer to engine service manual.
2. Saw will not raise.	Defective solenoid start switch?	Replace solenoid on hydraulic pump unit.
	Worn-out battery?	Charge or replace battery.
	Defective raise button?	Replace raise button.
3. Saw will not lower.	Debris in lowering valve stem?	Inspect and clean stem.
	Worn-out battery?	Charge or replace battery.
	Defective valve coil?	Check for magnetism of valve stem when activated.
	Defective lowering button?	Replace lowering button.
4. Saw will not completely lower.	Depth stop set?	Reset depth stop.
	Skid plates in wrong set of holes?	Use correct set of holes on skid plate.
5. Saw lowers too slow/too fast.	Improper lowering speed setting?	Adjust blade lowering speed valve.
6. Blade does not cut straight.	Drive alignment off?	Adjust rear axle adjustment bolt.
	Excessive force used when sawing?	Reduce forward speed. DO NOT twist blade from side-to-side.
	Wrong blade?	Contact dealer/manufacturer of blade.
7. Short belt life.	Loose belts causing slippage?	Check belt tension.
	Sheaves misaligned?	Use straightedge to check sheave alignment.
	Worn sheave grooves?	Check for groove wear and replace sheaves when necessary.
	Mismatched belts?	Replace with matched set of belts. DO NOT use old and new belts together.

## REFERENCES

### Appendix B

#### **CC3538JK RPM Chart**

**WARNING:** Do not exceed blade speed (RPM) shown for each blade size.  
Excessive blade speed could result in blade breakage and serious personal injury.

<b>CC3538JK RPM CHART</b>								
<b>BLADE SIZE</b>	<b>BLADE <sup>(1)</sup> RPM</b>	<b>BLADESHAFT SHEAVE</b>	<b>JACKSHAFT SHEAVE</b>	<b>JACKSHAFT SHEAVE</b>	<b>ENGINE SHEAVE</b>	<b>ENGINE RPM</b>	<b>FLANGE SIZE</b>	<b>MAX CUT DEPTH</b>
14"	3,000	3.65 in.	5.00 in.	6.00 in.	3.65 in.	3,600	5"	4-1/2"
20"	2,525	3.65 in.	5.60 in.	8.00 in.	3.65 in.	3,600	5"	7-1/2"
26"	1,895	4.12 in.	4.75 in.	8.00 in.	3.65 in.	3,600	5"	10-1/2"
30"	1,645	4.12 in.	4.12 in.	8.00 in.	3.65 in.	3,600	5"	12-1/2"

(1) Theoretical speed, actual speed may vary.

#### **CC3538JK Blade Size Conversion Charts**

**WARNING:** When changing blade size, use the chart below for selecting the correct items for the different configurations.

CC3538JK	14"	20"	26"	30"
Blade Guard Assembly	6010950	6010952	6010954	6010956
Engine Sheave (Sheave Size)	6011008 (3.65") Set Screw Style			
Jackshaft Sheave, Large (Sheave Size)	2506462 (6.0") Taper Style	2506454 (8.0") Taper Style		
Jackshaft Sheave, Large Taper Bushing (Bushing Size)	2506455 (1.5") Taper Style			
Jackshaft Sheave, Small (Sheave Size)	2506452 (5.0") Taper Style	2503926 (5.6") Taper Style	2500367 (4.75") Taper Style	6012190 (4.12") Set Screw Style
Jackshaft Sheave, Small Taper Bushing (Bushing Size)	2506455 (1.5") Taper Style			N/A
Blade Shaft Sheave (Sheave Size)	6011009 (3.65") Set Screw Style		6011010 (4.12") Set Screw Style	
Inner Blade Flange (2) (Flange Size)	6010255 (5")			
Outer Blade Flange (1) (Flange Size)	6047907 (5")			

### Appendix C

#### **Additional Resources**

1. Diamond Products ([www.diamondproducts.com](http://www.diamondproducts.com))
  - *CC3500J Saw Parts List; #1801378*
  - *A Guide for Professional Concrete Cutters*
  - *Training Manual – Introduction to Diamond Blades, Bits, and Equipment*
  - *Diamond Products' Equipment Catalog*
  - *Diamond Products' Website* ([www.diamondproducts.com](http://www.diamondproducts.com))
2. Kohler Engines ([www.KohlerEngines.com](http://www.KohlerEngines.com))
  - Kohler Command Pro EFI, ECH940 & ECH980 Service Manual
3. Concrete Sawing and Drilling Association ([www.csda.org](http://www.csda.org))
  - The CSDA has many helpful concrete cutting publications available to members and non-members.
4. Association of Equipment Manufacturers ([www.aem.org](http://www.aem.org))
  - The AEM has a variety of safety and technical manuals available for various types of equipment, along with a list of industry-standardized safety symbols.
5. Occupational Safety & Health Administration (OSHA) ([www.osha.gov/](http://www.osha.gov/))
  - OSHA provides information on work-related safety and health practices.
6. The National Institute for Occupational Safety and Health (NIOSH) ([www.cdc.gov/NIOSH/](http://www.cdc.gov/NIOSH/))
  - NIOSH provides information on work-related safety and health practices.









**Appendix D**

***Model and Serial Numbers***

Record the saw's serial number below for future reference and customer service purposes.

Serial Number	
---------------	--

Record the engine's model and serial numbers below for future reference and customer service purposes.

Model Number	
Serial Number	

## *REFERENCES*

## **EQUIPMENT AND PARTS WARRANTY**

Diamond Products warrants all equipment manufactured by it against defects in workmanship or materials for a period of one (1) year from the date of shipment to Customer.

The responsibility of Diamond Products under this Warranty is limited to replacement or repair of defective parts at Diamond Products' Elyria, Ohio factory, or at a point designated by it, of such parts as shall appear to us upon inspection at such parts, to have been defective in material or workmanship, with expense for transportation and labor borne by Customer.

In no event shall Diamond Products be liable for consequential or incidental damages arising out of the failure of any Product to operate properly.

Integral units such as engines, electric motors, batteries, transmissions, etc., are excluded from this Warranty and are subject to the prime manufacturer's warranty.

**THIS WARRANTY IS IN LIEU OF ALL OTHER WARRANTIES, EXPRESSED OR IMPLIED, AND ALL SUCH OTHER WARRANTIES ARE HEREBY DISCLAIMED.**



333 Prospect Street, Elyria, Ohio 44035  
(440) 323-4616 • (800) 321-5336 • Fax (800) 634-4035  
[www.diamondproducts.com](http://www.diamondproducts.com)