

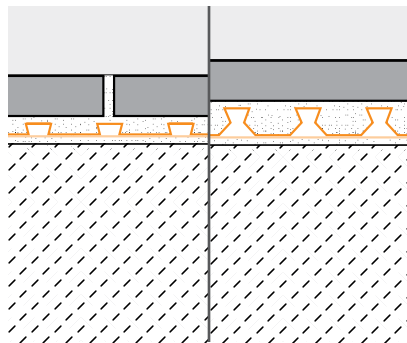

Schluter®-DITRA Installation Handbook 2018



The Universal Underlayment for Ceramic and Stone Tile

Schluter®-DITRA

Specifically designed as an underlayment for ceramic and stone tile

Ceramic and stone tiles are durable, easy to maintain, and hygienic, representing the ideal surface coverings. However, today's lightweight construction methods can make the installation of hard surface coverings particularly challenging. In order to protect the integrity of the tile assembly, an underlayment that performs multiple functions is required.

Schluter®-DITRA is specifically designed to allow the installation of ceramic and stone tile over any even and load-bearing substrate. The integration of DITRA's uncoupling, waterproofing, load-distribution, and vapor management functions makes consistent results viable.

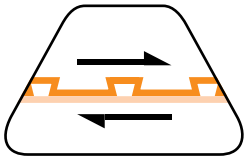

Uncoupling

Tile has been successfully installed for thousands of years by incorporating an uncoupling layer, or forgiving shear interface, within the tile assembly. **DITRA** provides uncoupling through its open rib structure, which allows for in-plane movement that effectively neutralizes the differential movement stresses between the substrate and the tile, thus eliminating the major cause of cracking and delaminating of the tiled surface.

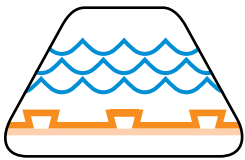

Waterproofing

DITRA provides reliable waterproofing. Its polyethylene composition protects the substrate from moisture penetration, which is particularly important in today's building environment where most substrates are moisture sensitive.

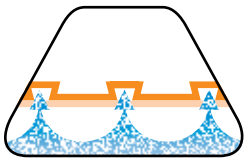

Vapor Management

The distinguishing feature of **DITRA** is the existence of free space created by the configured channels on the underside of the matting. The free space provides a route for excess moisture and vapor to escape from the substrate that could otherwise cause damage to the tile layer above. Thus, DITRA effectively manages moisture beneath the tile covering.

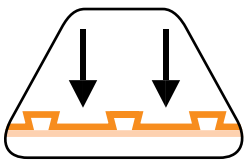

Support/Load Distribution

When placed on a solid foundation, columns or pillars can support tremendous loads. The same physical principle applies to **DITRA** installations. Column-like mortar structures are formed in the cutback cavities of the matting. Loads are transferred from the tile covering through these column-like mortar structures to the substrate. Since DITRA is virtually incompressible within the tile assembly, the advantages of uncoupling are achieved without sacrificing point load distribution capabilities. The ability of DITRA installations to support and distribute heavy loads while preserving the integrity of the tiled surface has been verified through extensive laboratory and field testing, including applications exposed to vehicular traffic.

Legend

- ★★★ Essential
- ★★ Significant
- ★ Helpful

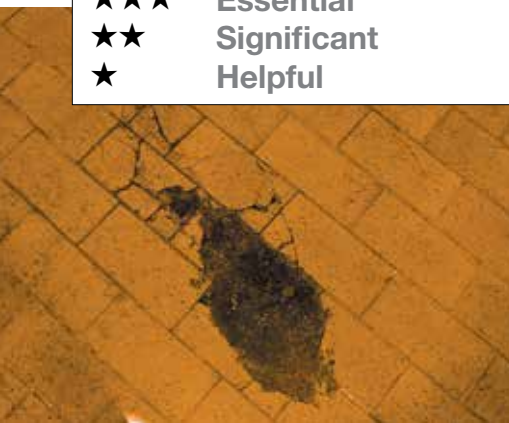

DITRA will forever change the way you lay tile.

CONTENTS

WOOD	4	Floors, Interior - 16, 19.2, & 24-inch o.c. joist spacing Floors, Interior - Natural Stone Tile Floors, Interior - Existing Vinyl Floors, Interior - Structural Plank Subfloor
CONCRETE	8	Floors, Interior - Ceramic or Stone Tile <ul style="list-style-type: none">• Young concrete• Concrete subject to moisture migration• Pre-stressed/post-tensioned concrete
GYPSUM	9	Floors, Interior - Ceramic or Stone Tile
HEATED FLOORS	10	Wood Substrate - Electric thin-mat or wire system Wood Substrate - Thin slab (lightweight or gypsum concrete) Concrete Substrate - Structural concrete slab
WATERPROOFING	12	Floors, Interior - Ceramic or Stone Tile
EXTERIOR APPLICATIONS	13	Floors, Exterior - Ceramic or Stone Tile
MOVEMENT JOINTS	14	Exterior Systems Planning Guide
WOOD UNDERLAYMENT	15	Placement guidelines and descriptions
INSTALLATION	18	Installation guidelines
THIN-SET FACTS	19	Schluter®-DITRA installation instructions
THIN-SET DISCUSSION	20	Discussion of thin-set mortar types to be used with Schluter®-DITRA
TESTING & CERTIFICATIONS	21	Evaluation of mortar types used with Schluter®-DITRA <ul style="list-style-type: none">• ASTM C627• Shear bond strength• Freeze/thaw exposure
HOW DOES IT WORK	22	Product Evaluation
NATURAL STONE	23	Explanation of how Schluter®-DITRA functions
SOUND CONTROL	24	Discussion of natural stone and single-layer wood subfloors
PRODUCT SELECTION	26	Discussion of sound control in conjunction with ceramic and stone tile
PRODUCT & ORDERING INFO	27	Choosing between Schluter®-DITRA and DITRA-XL
WARRANTIES	28	
	34	

This installation handbook is subject to change without notice. Please visit www.schluter.com for the latest version.

Schluter®-Systems' written installation instructions shall have precedence over referenced industry standard guidelines and installation procedures insofar as referenced information may contain overlapping or conflicting requirements. Type, thickness, and format of the ceramic or stone tile surface covering must be suitable for the intended application.

WOOD

Every substrate presents unique challenges

All wood materials, including OSB, plywood, and framing members, are subject to expansion, contraction, bending, and deflection as a result of changes in moisture content and loading. Further, these deformations fluctuate over the life of the building structure.

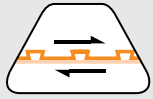

Schluter®-DITRA's uncoupling function protects the ceramic or stone tile covering from the aforementioned deformations by neutralizing the differential movement stresses between the wood structure and the tile, thus eliminating the major cause of cracking and delaminating of the tiled surface. Therefore, DITRA can replace a second layer of plywood in most applications.

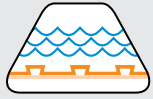

Since wood structures are sensitive to moisture, **DITRA's** waterproofing function adds an essential element to the flooring assembly by providing simple, effective, and permanent moisture protection.

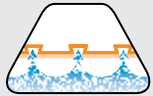

Wood continually absorbs and releases moisture. The free space beneath the **DITRA** membrane allows the wood to breathe and provides a route for any residual moisture in the wood substrate to escape.

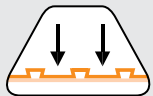

Since **DITRA** is virtually incompressible within the tile assembly, the advantages of uncoupling are achieved without sacrificing point load distribution capabilities.

By addressing all of the challenges associated with today's fast, lightweight construction methods, **DITRA** provides a durable installation system for ceramic and stone tile over wood substrates.

Floors, Interior - Ceramic or Porcelain Tile

D-W16-T-18

16" (406 mm) o.c. joist spacing, single layer OSB or plywood subfloor

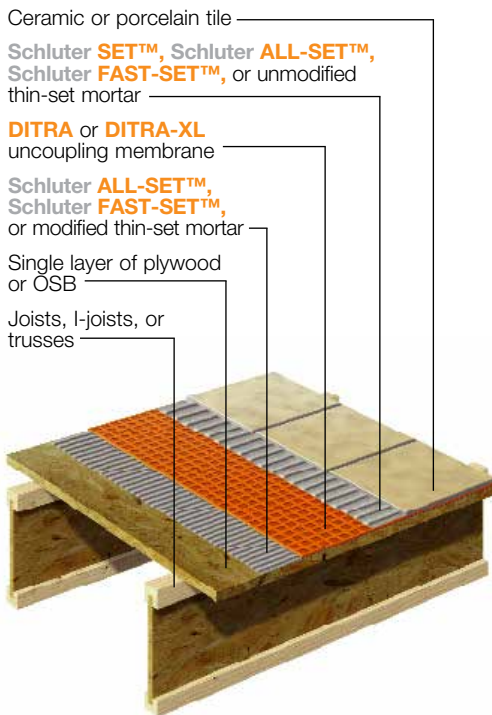

Ceramic or porcelain tile

Schluter SET™, Schluter ALL-SET™, Schluter FAST-SET™, or unmodified thin-set mortar

DITRA or DITRA-XL uncoupling membrane

Schluter ALL-SET™, Schluter FAST-SET™, or modified thin-set mortar

Single layer of plywood or OSB

Joists, I-joists, or trusses

Areas of Application

- ▲ over any even and structurally sound OSB or plywood subfloor with 16" (406 mm) o.c. joist spacing
- ▲ interior dry or wet areas

Limitations

- ▲ minimum 2" x 2" (50 mm x 50 mm) tile
- ▲ for natural stone, see detail D-W-S (page 6) and natural stone discussion (page 24)

Requirements

- ▲ maximum spacing of joists, I-joists, or floor trusses is 16" (406 mm) o.c.
- ▲ minimum subfloor thickness – 19/32", 5/8" nom. (16 mm) tongue-and-groove with 1/8" (3 mm) gap between sheets

Substrate Preparation

- ▲ verify that subfloor panels are properly fastened to framing members
- ▲ any leveling of the subfloor must be done prior to installing DITRA and DITRA-XL

Movement Joints

- ▲ DITRA and DITRA-XL do not eliminate the need for movement joints, including perimeter joints, within the tiled surface. Movement joints must be installed in accordance with industry standards and norms; see page 15 of this Handbook, TCNA EJ171, and TTMAC 301 MJ

Setting and Grouting Materials

- ▲ modified thin-set mortar – ANSI A118.11
- ▲ unmodified thin-set mortar – ANSI A118.1
- ▲ grout – ANSI A118.3, A118.6, A118.7, A118.8

Setting and Grouting Specifications

- ▲ tile – ANSI A108.5
- ▲ grout – ANSI A108.6, A108.9, A108.10

Other Considerations

- ▲ tightly butted and/or tented plywood or OSB seams must be addressed prior to installing DITRA and DITRA-XL
- ▲ vapor barrier on crawl space floors according to regional building codes
- ▲ where a waterproof floor is required, all DITRA and DITRA-XL seams and floor/wall transitions must be sealed with Schluter®-KERDI-BAND using Schluter SET™, Schluter ALL-SET™, Schluter FAST-SET™, or unmodified thin-set mortar; see page 12

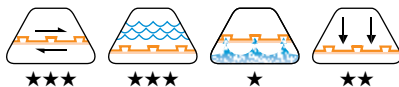

D-W19-T-18

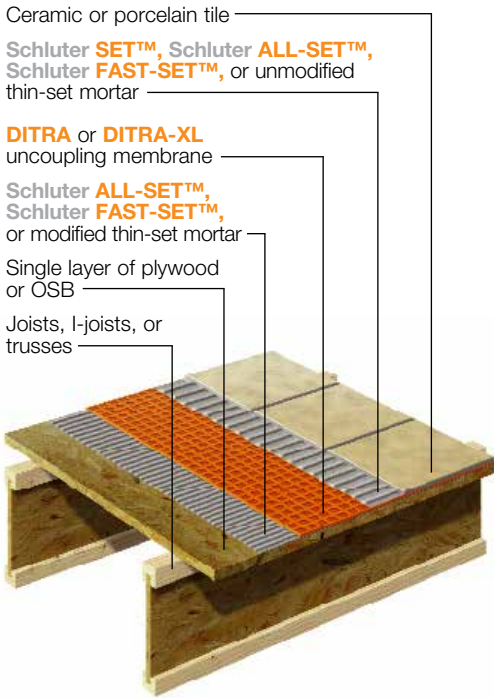

Ceramic or porcelain tile
 Schluter SET™, Schluter ALL-SET™, Schluter FAST-SET™, or unmodified thin-set mortar

DITRA or DITRA-XL uncoupling membrane

Schluter ALL-SET™, Schluter FAST-SET™, or modified thin-set mortar

Single layer of plywood or OSB

Joists, I-joists, or trusses

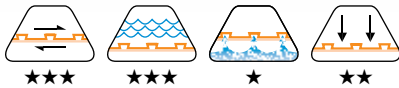

19.2" (488 mm) o.c. joist spacing, single layer OSB or plywood subfloor

Areas of Application

- ▲ over any even and structurally sound OSB or plywood subfloor with 19.2" (488 mm) o.c. joist spacing
- ▲ interior dry or wet areas

Limitations

- ▲ minimum 2" x 2" (50 mm x 50 mm) tile
- ▲ for natural stone, see detail D-W-S (page 6) and natural stone discussion (page 24)

Requirements

- ▲ maximum spacing of joists, I-joists, or floor trusses is 19.2" (488 mm) o.c.
- ▲ minimum subfloor thickness – 23/32", 3/4" nom. (19 mm) tongue-and-groove with 1/8" (3 mm) gap between sheets

Substrate Preparation

- ▲ verify that subfloor panels are properly fastened to framing members
- ▲ any leveling of the subfloor must be done prior to installing DITRA and DITRA-XL

Movement Joints

- ▲ DITRA and DITRA-XL do not eliminate the need for movement joints, including perimeter joints, within the tiled surface. Movement joints must be installed in accordance with industry standards and norms; see page 15 of this Handbook, TCNA EJ171, and TTMAC 301 MJ

Setting and Grouting Materials

- ▲ modified thin-set mortar – ANSI A118.11
- ▲ unmodified thin-set mortar – ANSI A118.1
- ▲ grout – ANSI A118.3, A118.6, A118.7, A118.8

Setting and Grouting Specifications

- ▲ tile – ANSI A108.5
- ▲ grout – ANSI A108.6, A108.9, A108.10

Other Considerations

- ▲ tightly butted and/or tented plywood or OSB seams must be addressed prior to installing DITRA and DITRA-XL
- ▲ vapor barrier on crawl space floors according to regional building codes
- ▲ where a waterproof floor is required, all DITRA and DITRA-XL seams and floor/wall transitions must be sealed with Schluter®-KERDI-BAND using Schluter SET™, Schluter ALL-SET™, Schluter FAST-SET™, or unmodified thin-set mortar; see page 12

D-W24-T-18

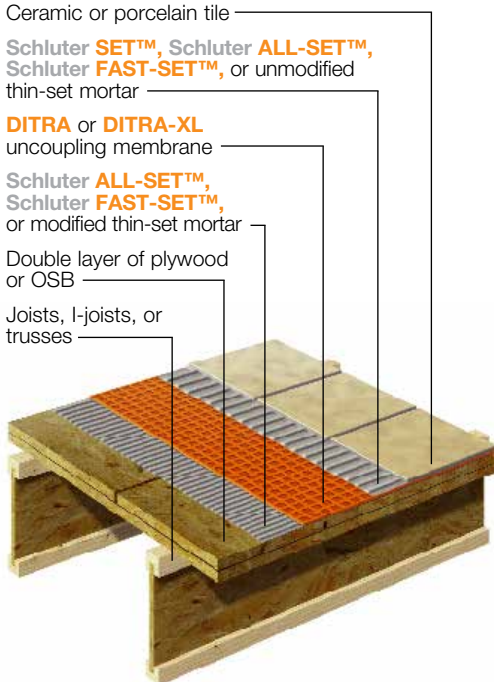

Ceramic or porcelain tile

Schluter SET™, Schluter ALL-SET™, Schluter FAST-SET™, or unmodified thin-set mortar

DITRA or DITRA-XL uncoupling membrane

Schluter ALL-SET™, Schluter FAST-SET™, or modified thin-set mortar

Double layer of plywood or OSB

Joists, I-joists, or trusses

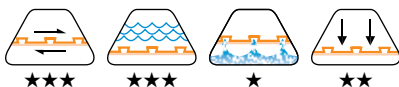

24" (610 mm) o.c. joist spacing, double layer OSB or plywood subfloor

Areas of Application

- ▲ over any even and structurally sound double layer OSB or plywood floor
- ▲ Interior dry or wet areas

Limitations

- ▲ minimum 2" x 2" (50 mm x 50 mm) tile

Requirements

- ▲ maximum spacing of I-joists or floor trusses is 24" (610 mm) o.c.
- ▲ double layer wood floor consisting of:
 - minimum subfloor thickness – 23/32", 3/4" nom. (19 mm) tongue-and-groove
 - minimum underlayment thickness – 11/32", 3/8" nom. (10 mm)

Substrate Preparation

- ▲ verify that subfloor panels are properly fastened to framing members
- ▲ underlayment – minimum 11/32", 3/8" nom. (10 mm)-thick Exposure 1, plugged-face plywood or OSB with 1/8" (3 mm) gap between sheets; see page 18 for underlayment installation guidelines
- ▲ any leveling of the assembly must be done prior to installing DITRA and DITRA-XL

Movement Joints

- ▲ DITRA and DITRA-XL do not eliminate the need for movement joints, including perimeter joints, within the tiled surface. Movement joints must be installed in accordance with industry standards and norms; see page 15 of this Handbook, TCNA EJ171, and TTMAC 301 MJ

Setting and Grouting Materials

- ▲ modified thin-set mortar – ANSI A118.11
- ▲ unmodified thin-set mortar – ANSI A118.1
- ▲ grout – ANSI A118.3, A118.6, A118.7, A118.8

Setting and Grouting Specifications

- ▲ tile – ANSI A108.5
- ▲ grout – ANSI A108.6, A108.9, A108.10

Other Considerations

- ▲ tightly butted and/or tented plywood or OSB seams must be addressed prior to installing DITRA and DITRA-XL
- ▲ vapor barrier on crawl space floors according to regional building codes.
- ▲ where a waterproof floor is required, all DITRA and DITRA-XL seams and floor/wall transitions must be sealed with Schluter®-KERDI-BAND using Schluter SET™, Schluter ALL-SET™, Schluter FAST-SET™, or unmodified thin-set mortar; see page 12
- ▲ ceramic or porcelain tile can be installed over single layer wood subfloors on joists spaced at 24" (610 mm) o.c. when using DITRA-XL; see detail D-W24-XL-T on page 6

D-W24-XL-T-18

Ceramic or porcelain tile

Schluter SET™, Schluter ALL-SET™, Schluter FAST-SET™, or unmodified thin-set mortar

DITRA-XL

uncoupling membrane

Schluter ALL-SET™, Schluter FAST-SET™, or modified thin-set mortar

Single layer of plywood or OSB

Joists, I-joists, or trusses

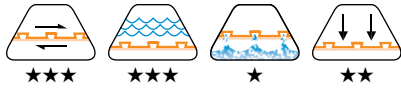
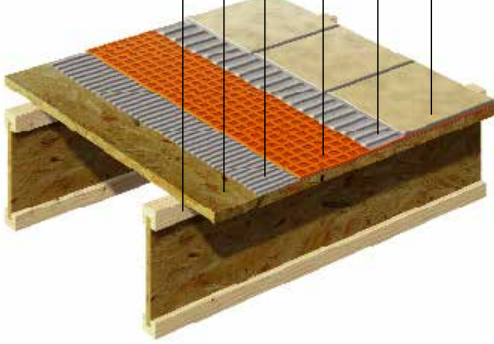

24" (610 mm) o.c. joist spacing, single layer OSB or plywood subfloor

Areas of Application

- ▲ over any even and structurally sound OSB or plywood subfloor with 24" (610 mm) o.c. joist spacing
- ▲ interior dry or wet areas

Limitations

- ▲ minimum 2" x 2" (50 mm x 50 mm) tile
- ▲ for natural stone, see detail D-W-S (page 6) and natural stone discussion (page 24)

Requirements

- ▲ maximum spacing of I-joists or floor trusses is 24" (610 mm) o.c.
- ▲ minimum subfloor thickness – 23/32", 3/4" nom. (19 mm) tongue-and-groove with 1/8" (3 mm) gap between sheets

Substrate Preparation

- ▲ verify that subfloor panels are properly fastened to framing members
- ▲ any leveling of the subfloor must be done prior to installing DITRA-XL

Movement Joints

- ▲ DITRA-XL does not eliminate the need for movement joints, including perimeter joints, within the tiled surface. Movement joints must be installed in accordance with industry standards and norms; see page 15 of this Handbook, TCNA EJ171, and TTMAC 301 MJ

Setting and Grouting Materials

- ▲ modified thin-set mortar – ANSI A118.11
- ▲ unmodified thin-set mortar – ANSI A118.1
- ▲ grout – ANSI A118.3, A118.6, A118.7, A118.8

Setting and Grouting Specifications

- ▲ tile – ANSI A108.5
- ▲ grout – ANSI A108.6, A108.9, A108.10

Other Considerations

- ▲ tightly butted and/or tented plywood or OSB seams must be addressed prior to installing DITRA-XL
- ▲ vapor barrier on crawl space floors according to regional building codes
- ▲ where a waterproof floor is required, all DITRA-XL seams and floor/wall transitions must be sealed with Schluter®-KERDI-BAND using Schluter SET™, Schluter ALL-SET™, Schluter FAST-SET™, or unmodified thin-set mortar; see page 12

Floors, Interior - Natural Stone Tile

D-W-S-18

Natural stone tile

Schluter SET™, Schluter ALL-SET™, Schluter FAST-SET™, or unmodified thin-set mortar

DITRA or DITRA-XL

uncoupling membrane

Schluter ALL-SET™, Schluter FAST-SET™, or modified thin-set mortar

Double layer of plywood or OSB

Joists, I-joists, or trusses

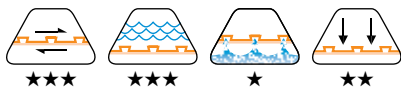
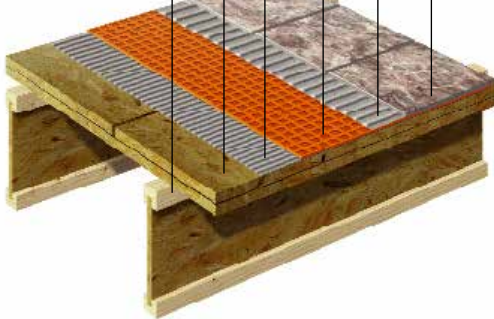

Double layer of OSB or Plywood subfloor

Areas of Application

- ▲ over any even and structurally sound double layer OSB or plywood floor
- ▲ interior dry or wet areas

Limitations

- ▲ requires double layer wood floor regardless of joist spacing
- ▲ minimum 2" x 2" (50 mm x 50 mm) tile

Requirements

- ▲ maximum spacing of joists, I-joists, or floor trusses is 24" (610 mm) o.c.
- ▲ double layer wood floor consisting of:
 - minimum subfloor thickness – 23/32", 3/4" nom. (19 mm) tongue-and-groove
 - minimum underlayment thickness – 11/32", 3/8" nom. (10 mm)

Substrate Preparation

- ▲ verify that subfloor panels are properly fastened to framing members
- ▲ underlayment – minimum 11/32", 3/8" nom. (10 mm)-thick Exposure 1, plugged-face plywood or OSB with 1/8" (3 mm) gap between sheets; see page 18 for underlayment installation guidelines
- ▲ any leveling of the assembly must be done prior to installing DITRA and DITRA-XL

Movement Joints

- ▲ DITRA and DITRA-XL do not eliminate the need for movement joints, including perimeter joints, within the tiled surface. Movement joints must be installed in accordance with industry standards and norms; see page 15 of this Handbook, TCNA EJ171, and TTMAC 301 MJ

Setting and Grouting Materials

- ▲ modified thin-set mortar – ANSI A118.11
- ▲ unmodified thin-set mortar – ANSI A118.1
- ▲ grout – ANSI A118.3, A118.6, A118.7, A118.8

Setting and Grouting Specifications

- ▲ tile – ANSI A108.5
- ▲ grout – ANSI A108.6, A108.9, A108.10

Other Considerations

- ▲ certain moisture-sensitive stones, e.g., green marble, or resin-backed tiles may require special setting materials. Consult stone supplier and Schluter®-Systems for more information
- ▲ tightly butted and/or tented plywood or OSB seams must be addressed prior to installing DITRA and DITRA-XL
- ▲ vapor barrier on crawl space floors according to regional building codes
- ▲ where a waterproof floor is required, all DITRA and DITRA-XL seams and floor/wall transitions must be sealed with Schluter®-KERDI-BAND using Schluter SET™, Schluter ALL-SET™, Schluter FAST-SET™, or unmodified thin-set mortar; see page 12

Floors, Interior - Existing Vinyl Floors

D-V-T-18

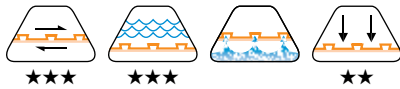
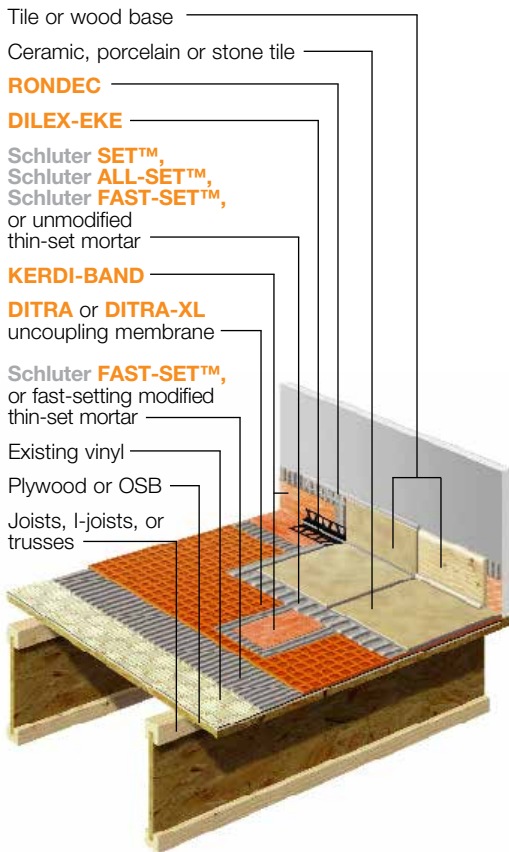

D-SP-TS-18

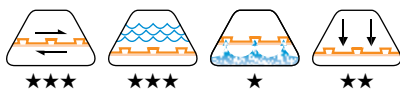
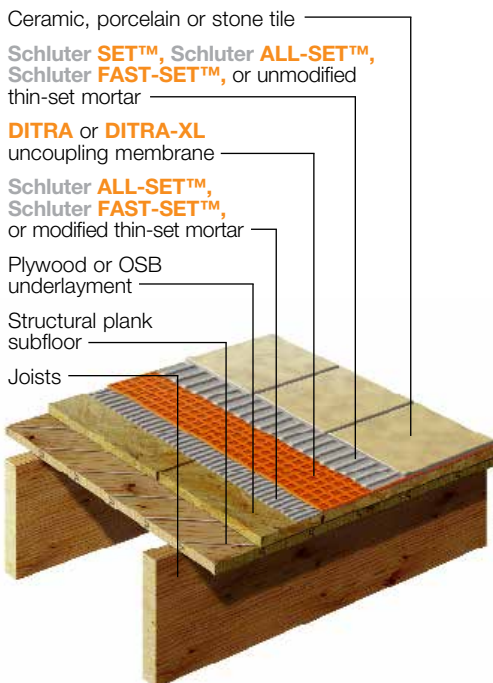

Areas of Application

- ▲ over any even and structurally sound substrate with existing vinyl flooring
- ▲ interior dry or wet areas

Limitations

- ▲ minimum 2" x 2" (50 mm x 50 mm) tile
- ▲ cushioned vinyl unacceptable
- ▲ perimeter bonded vinyl flooring unacceptable
- ▲ multiple layers of vinyl unacceptable

Requirements

- ▲ for wood substrates, subfloor/underlayment configuration according to detail D-W16-T, D-W19-T, D-W24-T, D-W24-XL-T, or D-W-S; D-W24-XL-T for use with DITRA-XL only

Substrate Preparation

- ▲ ensure that the structure beneath the vinyl is sound and adequate
- ▲ ensure that vinyl is well adhered
- ▲ remove any wax and clean vinyl
- ▲ for wood substrates, nail off floor with ring shank flooring nails every 4" (102 mm) o.c. – fasteners must pass through entire thickness of assembly with minimal penetration into joists
- ▲ any leveling of the assembly must be done prior to installing DITRA and DITRA-XL

Movement Joints

- ▲ DITRA and DITRA-XL do not eliminate the need for movement joints, including perimeter joints, within the tiled surface. Movement joints must be installed in accordance with industry standards and norms; see page 15 of this Handbook, TCNA EJ171, and TTMAC 301 MJ

Setting and Grouting Materials

- ▲ Fast-setting modified thin-set mortar – ANSI A118.4 or ANSI A118.11
- ▲ unmodified thin-set mortar – ANSI A118.1
- ▲ grout – ANSI A118.3, A118.6, A118.7, A118.8

Setting and Grouting Specifications

- ▲ tile – ANSI A108.5
- ▲ grout – ANSI A108.6, A108.9, A108.10

Other Considerations

- ▲ DITRA and DITRA-XL are adhered to the vinyl flooring using Schluter FAST-SET™ or fast-setting modified thin-set mortar suitable for bonding to vinyl. As an alternative, a suitable cement-based embossing leveler or Schluter ALL-SET™ or an appropriate modified thin-set mortar can be used to skim coat the vinyl to provide a bonding surface. When skim coat is cured, DITRA and DITRA-XL are adhered to the skim coat using Schluter SET™ or unmodified thin-set mortar. See page 21 for discussion on latex-modified thin-set mortars sandwiched between two impervious layers
- ▲ seaming DITRA and DITRA-XL, including floor/wall connections, with Schluter®-KERDI-BAND may be appropriate in cases where a break in the water line of an ice maker or dishwasher can damage pre-existing moisture-sensitive substrates and underlayments. KERDI-BAND floor/wall connections are just as easily concealed with wood base as with tile. KERDI-BAND floor/wall connections in dishwasher alcoves are parged with thin-set mortar; see page 12
- ▲ vapor barrier on crawl space floors according to regional building codes
- ▲ certain moisture-sensitive stones, e.g., green marble, or resin-backed tiles may require special setting materials. Consult stone supplier and Schluter®-Systems for more information

Floors, Interior - Structural Plank Subfloor

Areas of Application

- ▲ over structural plank subfloors
- ▲ interior dry or wet areas

Limitations

- ▲ minimum 2" x 2" (50 mm x 50 mm) tile

Requirements

- ▲ maximum spacing of joists is 24" (610 mm) o.c.
- ▲ double layer wood floor consisting of:
 - minimum structural plank subfloor thickness – 3/4" (19 mm)
 - minimum underlayment thickness – 15/32", 1/2" nom. (13 mm)

Substrate Preparation

- ▲ verify that subfloor planks are properly fastened to framing members
- ▲ underlayment – minimum 15/32", 1/2" nom. (13 mm)-thick Exposure 1, plugged-face plywood or OSB with 1/8" (3 mm) gap between sheets; see page 18 for underlayment installation guidelines
- ▲ any leveling of the assembly must be done prior to installing DITRA and DITRA-XL

Movement Joints

- ▲ DITRA and DITRA-XL do not eliminate the need for movement joints, including perimeter joints, within the tiled surface. Movement joints must be installed in accordance with

industry standards and norms; see page 15 of this Handbook, TCNA EJ171, and TTMAC 301 MJ

Setting and Grouting Materials

- ▲ modified thin-set mortar – ANSI A118.11
- ▲ unmodified thin-set mortar – ANSI A118.1
- ▲ grout – ANSI A118.3, A118.6, A118.7, A118.8

Setting and Grouting Specifications

- ▲ tile – ANSI A108.5
- ▲ grout – ANSI A108.6, A108.9, A108.10

Other Considerations

- ▲ vapor barrier on crawl space floors according to regional building codes
- ▲ where a waterproof floor is required, all DITRA and DITRA-XL seams and floor/wall transitions must be sealed with Schluter®-KERDI-BAND using Schluter SET™, Schluter ALL-SET™, Schluter FAST-SET™, or unmodified thin-set mortar; see page 12
- ▲ certain moisture-sensitive stones, e.g., green marble, or resin-backed tiles may require special setting materials. Consult stone supplier and Schluter®-Systems for more information

CONCRETE

Every substrate presents unique challenges

There are various challenges associated with the installation of hard surface coverings on concrete substrates.

To begin, the coefficient of thermal expansion of concrete is close to twice that of ceramic tile. Additionally, tile contractors are often expected to install tile over young concrete (concrete cured less than 28 days). However, rigid surface coverings installed over young concrete are susceptible to damage as a result of shrinkage during curing. Pre-stressed/post-tensioned concrete slabs are also commonplace in today's construction environment. Although pre-stressing is used to help control deflections in concrete structures, these slabs are still subject to deformations caused by changes in moisture, temperature, and loading. Many concrete slabs on or below grade are subject to moisture migration, which can be problematic. Furthermore, these structures experience the same deformations as stated above.

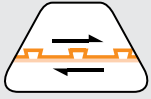

Schluter®-DITRA's uncoupling function protects the ceramic or stone tile covering by neutralizing the differential movement stresses between the concrete substrate and the tile, thus eliminating the major cause of cracking and delaminating of the tiled surface.

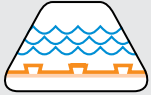

DITRA's waterproofing ability not only protects the substrate from moisture and harmful substances, it also slows the drying of fresh concrete, which reduces the chances of cracking and curling of the slab.

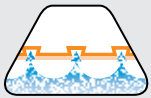

The free space beneath the **DITRA** matting provides a route for any residual moisture in the concrete slab to escape. This allows the installation of DITRA and the tile covering as soon as the slab can be walked upon. Vapor management is also essential for slabs subject to moisture migration.

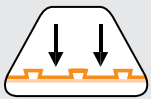

Since **DITRA** is virtually incompressible within the tile assembly, the advantages of uncoupling are achieved without sacrificing point load distribution capabilities. This allows DITRA to be installed in commercial and industrial applications exposed to heavy vehicular traffic, provided the type, format, and thickness of the tile is appropriate for the application.

By addressing all of the challenges associated with today's fast construction methods, **DITRA** provides a durable installation system for ceramic and stone tile over concrete substrates.

Floors, Interior - Ceramic or Stone Tile

Concrete subfloor

D-C-TS-18

Ceramic, porcelain or stone tile

Schluter SET™, Schluter ALL-SET™, Schluter FAST-SET™, or unmodified thin-set mortar

DITRA or DITRA-XL uncoupling membrane

Schluter SET™, Schluter ALL-SET™, Schluter FAST-SET™, or unmodified thin-set mortar

Concrete

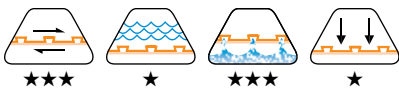
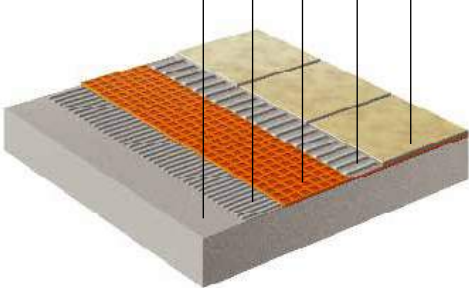

Areas of Application

- ▲ over any structurally sound and even concrete subfloor
- ▲ young concrete (concrete cured less than 28 days)
- ▲ on or below grade concrete subject to moisture migration
- ▲ post-tensioned or pre-stressed concrete
- ▲ cracked concrete

Limitations

- ▲ minimum 2" x 2" (50 mm x 50 mm) tile
- ▲ concrete slabs subject to moisture migration must have all seams in DITRA and DITRA-XL sealed with Schluter®-KERDI-BAND using Schluter SET™, Schluter ALL-SET™, Schluter FAST-SET™, or unmodified thin-set mortar
- ▲ any cracks in concrete subfloor must exhibit in-plane movement only; thin-set tile assemblies, including those incorporating DITRA or DITRA-XL, cannot accommodate differential vertical displacement

Requirements

- ▲ slab to be structurally sound
- ▲ slab to be free of waxy or oily films and curing compounds (when present, mechanical scarifying is necessary)
- ▲ the installation of DITRA or DITRA-XL and tile can begin as soon as the slab can be walked upon
- ▲ slab to be free of standing water

Substrate Preparation

- ▲ any leveling or sloping of the slab or assembly must be done prior to installing DITRA and DITRA-XL

Movement Joints

- ▲ DITRA and DITRA-XL do not eliminate the need for movement joints, including perimeter joints, within the tiled surface. Movement joints must be installed in accordance with industry standards and norms; see page 15 of this Handbook, TCNA EJ171, and TTMAC 301 MJ
- ▲ concrete floors may incorporate various movement joints; see page 18 of this Handbook for guidelines on how to treat the different types of joints (control/contraction joints, expansion joints, etc.)

Setting and Grouting Materials

- ▲ unmodified thin-set mortar – ANSI A118.1
- ▲ grout – ANSI A118.3, A118.6, A118.7, A118.8

Setting and Grouting Specifications

- ▲ tile – ANSI A108.5
- ▲ grout – ANSI A108.6, A108.9, A108.10

Other Considerations

- ▲ where a waterproof floor is required, all DITRA and DITRA-XL seams and floor/wall transitions must be sealed with Schluter®-KERDI-BAND using Schluter SET™, Schluter ALL-SET™, Schluter FAST-SET™, or unmodified thin-set mortar; see page 12
- ▲ certain moisture-sensitive stones, e.g., green marble, or resin-backed tiles may require special setting materials. Consult stone supplier and Schluter®-Systems for more information

GYPSUM

Every substrate presents unique challenges

Bonding ceramic or stone tiles directly to gypsum concrete substrates is generally considered questionable or not recommended. The challenges associated with gypsum-based underlayments include the requirement of an extended drying period before installing tile and continued sensitivity to the reintroduction of moisture throughout the life of the installation. In addition, since the coefficient of thermal expansion of gypsum concrete is substantially greater than that of ceramic tile, shear stresses caused by temperature fluctuations can result in delamination or cracking of the tile covering. This is particularly important when gypsum concrete is used as a thermal mass for radiant heated floors. With the increasing popularity of radiant heated floors, which typically utilize gypsum concrete, tile installers need a reliable installation system to address these issues.

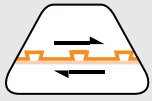

Schluter®-DITRA's uncoupling function protects the ceramic or stone tile covering by neutralizing the differential movement stresses between the gypsum concrete substrate and the tile, thus eliminating the major cause of cracking and delaminating of the tiled surface.

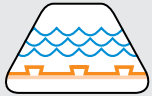

DITRA's waterproofing function prevents the reintroduction of moisture to gypsum concrete underlayments, which, if not prevented, could significantly compromise performance of the underlayment and lead to damage of the tiled surface.

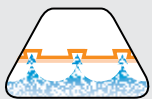

The residual moisture in gypsum concrete is allowed to escape through the air channels on the underside of the **DITRA** matting. This is particularly important since gypsum concrete must dry in order to gain strength.

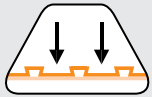

Since **DITRA** is virtually incompressible within the tile assembly, the advantages of uncoupling are achieved without sacrificing point load distribution capabilities.

By addressing all of the challenges associated with today's fast, lightweight construction methods, **DITRA** provides a durable installation system for ceramic and stone tile over gypsum substrates.

Floors, Interior - Ceramic or Stone Tile

D-G-TS-18

Ceramic, porcelain or stone tile

Schluter **SET™**, Schluter **ALL-SET™**, Schluter **FAST-SET™**, or unmodified thin-set mortar

DITRA or **DITRA-XL** uncoupling membrane

Schluter **SET™**, Schluter **ALL-SET™**, Schluter **FAST-SET™**, or unmodified thin-set mortar

Gypsum concrete

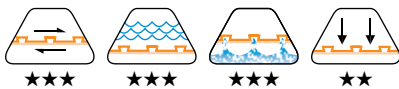
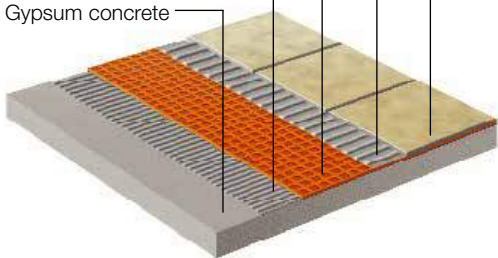

Gypsum concrete

Areas of Application

- ▲ over gypsum concrete underlayment placed over structurally sound wood or concrete subfloors
- ▲ interior dry or wet areas

Limitations

- ▲ minimum 2" x 2" (50 mm x 50 mm) tile

Requirements

- ▲ for wood substrates, subfloor/underlayment configuration according to detail D-W16-T, D-W19-T, D-W24-T, or D-W24-XL-T; D-W24-XL-T for use with DITRA-XL only
- ▲ where radiant heat tubes are laid over the subfloor, gypsum poured to a height that is 3/4" (19 mm) above the tops of the tubes is required before installing DITRA and DITRA-XL
- ▲ residual moisture in gypsum screed, 2.0% (percentage by volume) or less before installing DITRA and DITRA-XL

Substrate Preparation

- ▲ gypsum – follow manufacturer's directions

Movement Joints

- ▲ DITRA and DITRA-XL do not eliminate the need for movement joints, including perimeter joints, within the tiled surface. Movement joints must be installed in accordance with industry standards and norms; see page 15 of this Handbook, TCNA EJ171, and TTMAC 301 MJ

Setting and Grouting Materials

- ▲ unmodified thin-set mortar – ANSI A118.1
- ▲ grout – ANSI A118.3, A118.6, A118.7, A118.8

Installation Specifications

- ▲ tile – ANSI A108.5
- ▲ grout – ANSI A108.6, A108.9, A108.10
- ▲ gypsum – follow manufacturer's recommendations

Other Considerations

- ▲ since DITRA and DITRA-XL must bond to the gypsum concrete, follow gypsum manufacturer's recommendations regarding primers and/or special surface preparation before installing DITRA and DITRA-XL
- ▲ where a waterproof floor is required, all DITRA and DITRA-XL seams and floor/wall transitions must be sealed with Schluter®-KERDI-BAND using Schluter SET™, Schluter ALL-SET™, Schluter FAST-SET™, or unmodified thin-set mortar; see page 12
- ▲ certain moisture-sensitive stones, e.g., green marble, or resin-backed tiles may require special setting materials. Consult stone supplier and Schluter®-Systems for more information
- ▲ vapor barrier on crawl space floors according to regional building codes

HEATED FLOORS

Every substrate presents unique challenges

Radiant heating is one of the fastest growing market segments in the construction industry. Unlike other surface coverings, the low thermal resistivity of ceramic and stone tiles allows them to be used in radiant heat applications without sacrificing the energy efficiency of the system. However, there are inherent challenges in combining rigid surface coverings with radiant panel heating systems. A viable installation system must address the magnified fluctuations in temperature that contribute to increased shear stresses between the heated assembly and the tile covering. The system must also limit thermal striping by promoting even heat distribution and protect the assembly from moisture, which is particularly important when gypsum concrete is used as the thermal mass.

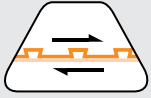

Differential movement stresses are magnified in radiant-heated floor applications because of significant temperature gradients. **Schluter®-DITRA's** uncoupling function protects the ceramic or stone tile covering by neutralizing the differential movement stresses between the heated assembly and the tile, thus eliminating the major cause of cracking and delaminating of the tiled surface.

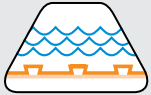

DITRA's waterproofing function provides simple, effective, and permanent protection for moisture-sensitive substrates, such as gypsum concrete and wood, used in heated floor applications.

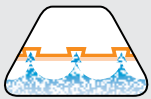

The open rib structure of the **DITRA** matting allows the residual moisture in the substrate to escape. This is particularly important for gypsum concrete since it must dry in order to gain strength. In addition, the free space beneath the matting limits thermal striping by promoting even heat distribution throughout the assembly.

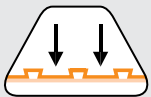

Since **DITRA** is virtually incompressible within the tile assembly, the advantages of uncoupling are achieved without sacrificing point load distribution capabilities.

DITRA provides a reliable installation system that allows the integration of radiant heat and rigid surface coverings, enabling the tile contractor to take advantage of this rapidly growing market segment.

Wood Substrate

D-RE-18

Ceramic, porcelain or stone tile

Schluter SET™, Schluter ALL-SET™, Schluter FAST-SET™, or unmodified thin-set mortar

DITRA or DITRA-XL uncoupling membrane

Schluter SET™, Schluter ALL-SET™, Schluter FAST-SET™, or unmodified thin-set mortar

Electric thin-mat or wire

Schluter ALL-SET™, Schluter FAST-SET™, or modified thin-set mortar

Plywood or OSB

Joists, I-joists, or trusses

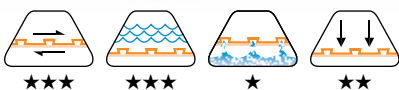
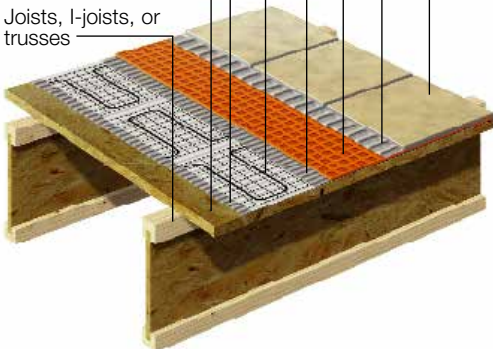

Electric thin-mat or wire system

Areas of Application

- ▲ over any even and structurally sound substrate
- ▲ interior dry or wet areas according to heating system manufacturer's recommendations

Limitations

- ▲ minimum 2" x 2" (50 mm x 50 mm) tile

Requirements

- ▲ for wood substrates, subfloor/underlayment configuration according to detail D-W16-T, D-W19-T, D-W24-T, D-W24-XL-T, or D-W-S; D-W24-XL-T for use with DITRA-XL only
- ▲ for concrete substrates, see detail D-C-TS

Substrate Preparation

- ▲ any leveling of the assembly must be done prior to installing DITRA and DITRA-XL
- ▲ additional preparation according to heating system manufacturer's directions

Movement Joints

- ▲ DITRA and DITRA-XL do not eliminate the need for movement joints, including perimeter joints, within the tiled surface. Movement joints must be installed in accordance with industry standards and norms; see page 15 of this Handbook, TCNA EJ171, and TTMAC 301 MJ

Setting and Grouting Materials

- ▲ modified thin-set mortar – ANSI A118.11
- ▲ unmodified thin-set mortar – ANSI A118.1
- ▲ grout – ANSI A118.3, A118.6, A118.7, A118.8

Setting and Grouting Specifications

- ▲ tile – ANSI A108.5
- ▲ grout – ANSI A108.6, ANSI A108.9, ANSI A108.10

- ▲ heating system – follow manufacturer's directions

Other Considerations

- ▲ install heating cable system per heating manufacturer's directions; encapsulate heating cables in a skim coat of Schluter ALL-SET™, Schluter FAST-SET™, modified thin-set mortar or a cement-based leveling compound and allow to cure before installing DITRA or DITRA-XL with Schluter SET™ or unmodified thin-set mortar
- ▲ install electric thin-mat per heating manufacturer's directions and install DITRA or DITRA-XL with Schluter SET™, Schluter ALL-SET™, Schluter FAST-SET™, or unmodified thin-set mortar
- ▲ vapor barrier on crawl space floors according to regional building codes
- ▲ where a waterproof floor is required, all DITRA and DITRA-XL seams and floor/wall transitions must be sealed with Schluter®-KERDI-BAND using Schluter SET™, Schluter ALL-SET™, Schluter FAST-SET™, or unmodified thin-set mortar; see page 12
- ▲ certain moisture-sensitive stones, e.g., green marble or resin-backed tiles, may require special setting materials. Consult stone supplier and Schluter®-Systems for more information
- ▲ Schluter®-DITRA-HEAT is an uncoupling membrane designed to secure heating cables without encapsulating them in leveling compounds; see schluter.com for more information

Wood Substrate

D-RHTS-18

Ceramic, porcelain or stone tile

Schluter SET™, Schluter ALL-SET™, Schluter FAST-SET™, or unmodified thin-set mortar

DITRA or DITRA-XL uncoupling membrane

Schluter SET™, Schluter ALL-SET™, Schluter FAST-SET™, or unmodified thin-set mortar

Lightweight or gypsum concrete

Even and structurally sound substrate

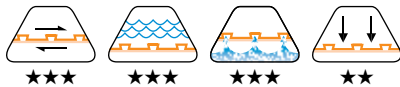
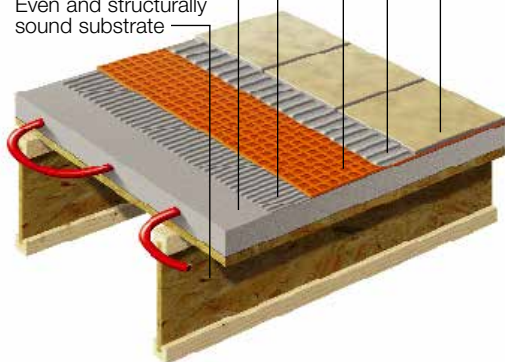

Thin slab (lightweight or gypsum concrete)

Areas of Application

- ▲ over lightweight or gypsum concrete thin slab placed over structurally sound wood or concrete subfloor
- ▲ interior dry or wet areas

Limitations

- ▲ minimum 2" x 2" (50 mm x 50 mm) tile

Requirements

- ▲ for wood substrates, subfloor/underlayment configuration according to detail D-W16-T, D-W19-T, D-W24-T, or D-W24-XL-T; D-W24-XL-T for use with DITRA-XL only
- ▲ where radiant heat tubes are laid over the subfloor, gypsum or concrete fill poured to a height that is 3/4" (19 mm) above the tops of the tubes is required before installing DITRA and DITRA-XL
- ▲ residual moisture in gypsum concrete, 2.0% (percentage by volume) or less before installing DITRA and DITRA-XL

Substrate Preparation

- ▲ gypsum or concrete – follow manufacturer's directions and/or design specifications
- ▲ additional substrate preparation according to heating system manufacturer's directions

Movement Joints

- ▲ DITRA and DITRA-XL do not eliminate the need for movement joints, including perimeter joints, within the tiled surface. Movement joints must be installed in accordance with

industry standards and norms; see page 15 of this Handbook, TCNA EJ171, and TTMAC 301 MJ

Setting and Grouting Materials

- ▲ unmodified thin-set mortar – ANSI A118.1
- ▲ grout – ANSI A118.3, A118.6, A118.7, A118.8

Setting and Grouting Specifications

- ▲ tile – ANSI A108.5
- ▲ grout – ANSI A108.6, A108.9, A108.10
- ▲ heating system – follow manufacturer's directions

Other Considerations

- ▲ if gypsum concrete is used, follow gypsum manufacturer's recommendations regarding primers and/or special surface preparation before installing DITRA and DITRA-XL
- ▲ vapor barrier on crawl space floors according to regional building codes
- ▲ where a waterproof floor is required, all DITRA and DITRA-XL seams and floor/wall transitions must be sealed with Schluter®-KERDI-BAND using Schluter SET™, Schluter ALL-SET™, Schluter FAST-SET™, or unmodified thin-set mortar; see page 12
- ▲ certain moisture-sensitive stones, e.g., green marble, or resin-backed tiles may require special setting materials. Consult stone supplier and Schluter®-Systems for more information

Concrete Substrate

D-RHSS-18

Ceramic, porcelain or stone tile

Schluter SET™, Schluter ALL-SET™, Schluter FAST-SET™, or unmodified thin-set mortar

DITRA or DITRA-XL uncoupling membrane

Schluter SET™, Schluter ALL-SET™, Schluter FAST-SET™, or unmodified thin-set mortar

Concrete

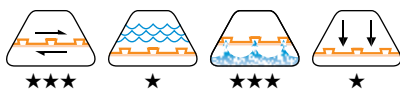
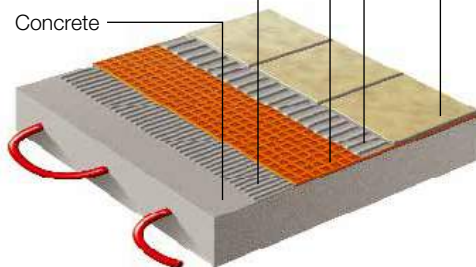

Structural concrete slab

Areas of Application

- ▲ over structurally sound and even radiant-heated concrete floors
- ▲ young concrete (concrete cured less than 28 days)
- ▲ on or below grade concrete subject to moisture migration
- ▲ cracked concrete

Limitations

- ▲ minimum 2" x 2" (50 mm x 50 mm) tile
- ▲ concrete slabs subject to moisture migration must have all seams in DITRA and DITRA-XL sealed with Schluter®-KERDI-BAND using Schluter SET™, Schluter ALL-SET™, Schluter FAST-SET™, or unmodified thin-set mortar
- ▲ any cracks in concrete subfloor must exhibit in-plane movement only; thin-set tile assemblies, including those incorporating DITRA or DITRA-XL, cannot accommodate differential vertical displacement

Requirements

- ▲ slab to be structurally sound
- ▲ slab to be free of waxy or oily films and curing compounds (when present, mechanical scarifying is necessary)
- ▲ the installation of DITRA or DITRA-XL and tile can begin as soon as the slab can be walked upon
- ▲ slab to be free of standing water

Substrate Preparation

- ▲ any leveling or sloping of the slab or assembly must be done prior to installing DITRA and DITRA-XL

Movement Joints

- ▲ DITRA and DITRA-XL do not eliminate the need for movement joints, including perimeter joints, within the tiled surface. Movement joints must be installed in accordance with industry standards and norms; see page 15 of this Handbook, TCNA EJ171, and TTMAC 301 MJ
- ▲ concrete floors may incorporate various movement joints; see page 16 of this Handbook for guidelines on how to treat the different types of joints (control/contraction joints, expansion joints, etc.)

Setting and Grouting Materials

- ▲ unmodified thin-set mortar – ANSI A118.1
- ▲ grout – ANSI A118.3, A118.6, A118.7, A118.8

Setting and Grouting Specifications

- ▲ tile – ANSI A108.5
- ▲ grout – ANSI A108.6, A108.9, A108.10

Other Considerations

- ▲ where a waterproof floor is required, all DITRA and DITRA-XL seams and floor/wall transitions must be sealed with Schluter®-KERDI-BAND using Schluter SET™, Schluter ALL-SET™, Schluter FAST-SET™, or unmodified thin-set mortar; see page 12
- ▲ certain moisture-sensitive stones, e.g., green marble, or resin-backed tiles may require special setting materials. Consult stone supplier and Schluter®-Systems for more information

WATERPROOFING

Every substrate presents unique challenges



Today's construction methods, which include the use of lightweight, moisture-sensitive materials, such as plywood, OSB, and gypsum concrete, have made the installation of hard surface coverings particularly challenging. If wood or gypsum concrete substrates are exposed to moisture, the tile layer above can be damaged as a result.

Typical areas that require waterproofing include tub surrounds, showers, and barrier free showers. Barrier-free tiled showers eliminate the use of a curb and rely on the slope of the floor to keep water inside the stall, thus improving accessibility. Waterproofing must be installed in all areas subjected to water exposure in barrier-free shower applications. Ideally, the entire floor is protected. There are other commonly tiled areas that may, through unexpected circumstances, become exposed to significant amounts of water; for example, an overflowed toilet, or ruptured dishwasher, icemaker, or washing machine lines, which can result in flooding.

Waterproofing these floors can save an owner from replacing the tile assembly and substructure in the event of a leak. **Schluter®-DITRA** and **Schluter®-DITRA-XL** installations can be made waterproof with minimal effort. Since the mattings are made of waterproof polyethylene, the only extra step necessary is to seal the seams and floor/wall connections. This is easily accomplished by applying Schluter®-KERDI-BAND to these areas using Schluter SET™, Schluter ALL-SET™, Schluter FAST-SET™, or unmodified thin-set mortar. The result is a waterproof installation that will not suffer damage in the event of an unexpected water leak. Schluter®-KERDI-DRAIN or Schluter®-KERDI-LINE may be used to provide drainage in DITRA and DITRA-XL installations.

DITRA and DITRA-XL meet the requirements of the American National Standard for Load Bearing, Bonded, Waterproof Membranes for Thin-Set Ceramic Tile and Dimension Stone Installations (ANSI A118.10), and are listed by cUPC® and evaluated by ICC-ES (ESR-2467 and PMG-1204).

Floors, Interior - Ceramic or Stone Tile

D-WP-18

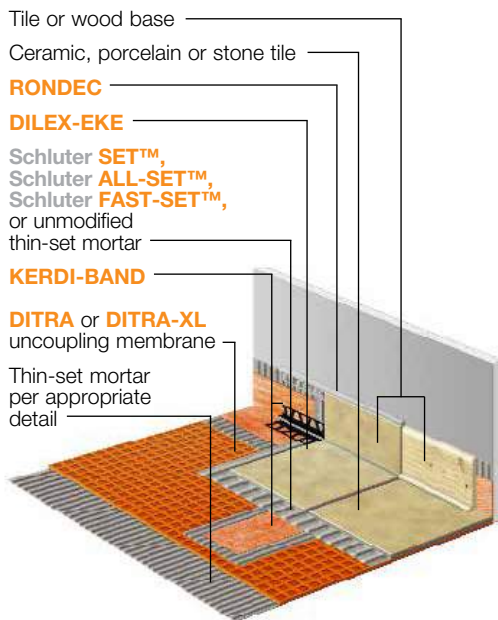

Areas of Application

- ▲ over any even and structurally sound substrate where waterproofing is desired

Limitations

- ▲ minimum 2" x 2" (50 mm x 50 mm) tile

Requirements

- ▲ all seams in DITRA and DITRA-XL matting and floor/wall transitions must be sealed with KERDI-BAND using Schluter SET™, Schluter ALL-SET™, Schluter FAST-SET™, or unmodified thin-set mortar. Note: KERDI-BAND must lap DITRA at seams and at floor/wall transitions by a minimum of 2" (50 mm) in order to maintain waterproof integrity

Other Considerations

- ▲ seaming DITRA and DITRA-XL, including floor/wall connections, with KERDI-BAND may be appropriate in cases where a break in the water line of an ice maker or dishwasher can damage pre-existing moisture-sensitive substrates and underlayments. KERDI-BAND floor/wall connections are just as easily concealed with wood base as with tile. KERDI-BAND floor/wall connections in dishwasher alcoves are parged with thin-set mortar
- ▲ in some applications the vertical section of the floor/wall transition will not accept a bond to unmodified thin-set mortar. Connections to such elements can be achieved using Schluter®-KERDI-FIX or suitable trowel-applied waterproofing materials, such as those that require atmospheric moisture to cure (e.g., urethane sealant)
- ▲ KERDI-DRAIN or KERDI-LINE may be used to provide drainage in DITRA and DITRA-XL applications. DITRA/DITRA-XL is sealed to the fleece-laminated KERDI-DRAIN bonding flange with a section of KERDI membrane using Schluter SET™, Schluter ALL-SET™, Schluter FAST-SET™, or unmodified thin-set mortar. KERDI-FIX is used to seal the section of KERDI to the stainless steel KERDI-DRAIN bonding flange. DITRA/DITRA-XL is sealed to the KERDI waterproofing collar on KERDI-LINE using Schluter SET™, Schluter ALL-SET™, Schluter FAST-SET™, or unmodified thin-set mortar

EXTERIOR APPLICATIONS

Every substrate presents unique challenges

Ceramic and stone tiles are ideal surface coverings for the exterior and have been used successfully for thousands of years. Exterior balconies and terraces are ideal opportunities for the installation of tiled surfaces. However, these installations have typically presented significant challenges to tile setters. Since hard surface coverings are rigid by nature and have different physical properties compared to virtually every substrate, they cannot be bonded directly to the substrate, particularly in exterior applications where they are exposed to potentially severe climatic changes and the recurring introduction of moisture.



Schluter®-DITRA's uncoupling function protects the ceramic or stone tile covering by neutralizing the differential movement stresses between the substrate and the tile, thus eliminating the major cause of cracking and delaminating of the tiled surface. This is particularly important since these stresses are magnified by the significant temperature gradients common to exterior applications.

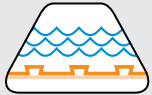

DITRA provides effective waterproofing that will protect the tile assembly from the recurring introduction of water, which is common in exterior applications.

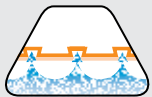

The free space beneath the **DITRA** matting provides a route for any residual moisture in the substrate to escape. This is especially important when installing tile over a young slab, concrete slabs subject to moisture migration, or a fresh mortar bed.

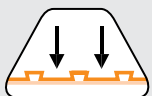

Since **DITRA** is virtually incompressible within the tile assembly, the advantages of uncoupling are achieved without sacrificing point load distribution capabilities.

Because **DITRA** is uniquely engineered to provide uncoupling, vapor management, and waterproofing, all of which are essential functions in exterior environments, it provides a reliable installation system for ceramic and stone tile surface coverings in exterior applications.



Exterior Systems Planning Guide

A successful installation involves proper planning and following the appropriate exterior detail. This checklist is designed to help you evaluate the conditions when planning an exterior tile assembly. **If all items listed cannot be satisfied, there is risk of assembly failure and no warranty will be provided. In that case, we recommend not proceeding with the project.** If all items can be satisfied, please contact Schluter®-Systems for recommended details.

Ensure suitability of the balcony structure

The structure must be able to support the weight of the proposed tile assembly. The typical weight of an exterior tile assembly with a 1-1/2" (38 mm) -thick mortar bed weighs 24 pounds/square foot according to the TCNA Handbook for Ceramic, Glass, and Stone Tile Installation. This will vary depending on materials selected for your particular installation. The owner should work with a design professional (e.g., engineer, architect, etc.) to ensure the structure is suitable for the intended use and complies with applicable building codes.

Ensure adequate room for proper installation

The structure must allow for the height of the installed tile assembly. Provide adequate room to ensure the installer can create or maintain slope away from the building, which will allow for the installation of roofing membrane flashing, particularly at door openings. Additionally, sufficient elevation drop from the interior to exterior at door thresholds is recommended to keep water from entering the building.

Ensure moisture management throughout the assembly

- Sufficient slope (1.5 – 2.0%).
- Protect the balcony structure with a roofing membrane. Membrane installation to be completed by roofing professional. Schluter®-Systems does not supply roofing membranes or warranty structural waterproofing in exterior applications.
- Appropriate flashing must be installed where required and all protrusions must be sealed.
- Include a drainage membrane (e.g., TROBA or TROBA-PLUS) in assemblies with mortar beds.
- Water must be directed away from the structure including the use of flashing and a drip edge (e.g., BARA) at the perimeter of the assembly. A gutter system (e.g., BARIN) installed with edging profiles is the most complete solution. This combination provides edge finishing and water management at balcony and terrace perimeters. When parapet walls are surrounding the assembly, a floor drain may be used. Considerations of drain installation should be taken into account during design of the assembly.

Ensure full thin-set mortar coverage during tile installation

ANSI A108.5 requires 95% contact area between tiles and thin-set mortar in exterior applications. The coverage must be distributed to give full support to the tile with particular attention to the corners. Back-buttering is a useful way to help ensure proper coverage, particularly when installing large-format tiles. By back-buttering, it is possible to fill in the concave area on the back of the tile (ceramic tiles are not perfectly flat) and improve contact with the mortar combed on the substrate. Combing the mortar in one direction can also improve coverage by making it easier to collapse the mortar ridges when embedding the tiles.

Ensure installation of movement joints

DITRA does not eliminate the need for movement joints, which are essential in any installation. Provide perimeter joints at all restraining surfaces (e.g., walls, railings, etc.). In exterior applications surface movement joints must be placed every 8' - 12' (2.4 m – 3.7 m) in each direction.

Ensure appropriate railing design and installation

It is recommended to choose under- or side-mounted railing systems when practical to avoid roofing membrane penetration. While not recommended, if a top-mounted railing system is the only option available, care must be taken to ensure that protrusions through the waterproofing layer(s) are sealed by the roofing professional.

Materials Selection

- Exterior applications have the potential for surface water, which may create slippery surfaces. Therefore, consider the slip resistance of the tile and select a material recommended by the manufacturer for the intended use. It is recommended that tiles are tested according to the ANSI A137.1 DCOF AcuTest method to evaluate Dynamic Coefficient of Friction. Please refer to the TCNA Handbook for Ceramic, Glass, and Stone Tile Installation for further information.
- For assemblies exposed to freeze-thaw conditions, the tile must be frost-resistant and recommended by the tile manufacturer for the intended use. It is recommended that the tiles are tested according to the ASTM C1026 Standard Test Method for Measuring the Resistance of Ceramic and Glass Tile to Freeze-Thaw Cycling.
- When selecting profiles, use color-coated aluminum, PVC, or stainless steel. When stainless steel profiles are exposed to de-icing salts, use stainless steel 316L (1.4404 = V4A).

Respect exterior working conditions

Working in exterior environments involves considerations during installation and curing of the tile assembly. Observe temperature ranges required by the setting material manufacturer during both installation and curing. Tenting of working area may be necessary to shade the surfaces from direct sunlight and/or rain. Direct sun or high temperatures may cause issues such as flash setting or skinning of the mortar. If an installation is to be completed in cold temperatures, heat will be required in the space before, during and after installation to ensure proper curing of the mortar. Combustion heaters must be vented for carbon monoxide safety.

If acceptable working conditions cannot be maintained, stop the installation.

Lastly, efflorescence is considered to be a natural occurrence with cementitious materials and is therefore not to be considered a defective condition. Since exterior tile assemblies are installed with cementitious thin-set mortars and grouts and exposed to water, there is always the possibility of efflorescence.

MOVEMENT JOINTS

Every substrate presents unique challenges



DISCUSSION

Movement joints are an integral part of any tile assembly. The various components of a tile assembly (tile, mortar, substrate, etc.) have unique physical characteristics that affect their behavior. Specifically, these components will expand and contract at different rates, according to each component's intrinsic physical properties, with changes in moisture, temperature, and loading (both dead and live loads). This differential expansion/contraction of attached components results in internal stresses. Furthermore, structures that restrain overall expansion of the tile field (walls, columns, etc.) cause stress buildup within the system. If the aforementioned movements are not accommodated through the use of movement joints in the tile field and at restraining structures, the resulting stresses can cause cracking of the grout and tile and delamination of the tile from the substrate. Thus, movement joints are an essential component of any durable tile assembly.

SOLUTIONS

Movement joints must be incorporated within the tile field, at doorsills, and at transitions to walls and other restraining structures to allow movement of the assembly and prevent stresses that can damage the system. Schluter®-Systems' prefabricated movement joint profiles protect tile edges and prevent sound bridges and surface water penetration, resulting in a permanent, maintenance-free installation. The family of **Schluter®-DILEX** prefabricated movement profiles includes a variety of shapes, sizes, and materials to suit different applications. Please see Schluter®-Systems' Illustrated Price List and visit www.schluter.com for more detailed information on DILEX movement profiles.

TECHNICAL NOTES

The Tile Council of North America (TCNA) and the Terrazzo, Tile, and Marble Association of Canada (TTMAC) provide guidelines (EJ171 and 301MJ, respectively) for the placement and construction of movement joints in and around the tile field. Schluter®-Systems accepts these guidelines. However, given the increased use of larger tiles, smaller grout joints, and lighter building materials, which are more susceptible to movement, Schluter®-Systems recommends that movement joints within the tile field be placed at more frequent intervals, as indicated below.

Guidelines for the placement of movement joints

- ▲ Field size not to exceed 400 ft² (37.0 m²)
- ▲ Interior applications: 16' - 20' (4.9 m - 6.1 m) in each direction
- ▲ Interior areas exposed to direct sunlight, moisture, or heated floors: 12' - 16' (3.7 m - 4.9 m) in each direction
- ▲ Exterior: 8' - 12' (2.4 m - 3.7 m) in each direction
- ▲ Place around the perimeter of any size floor and/or against all restraining surfaces
- ▲ Fields should be as square as possible. The ratio between length and width should not exceed 1:1.5.

Typical movement joint applications

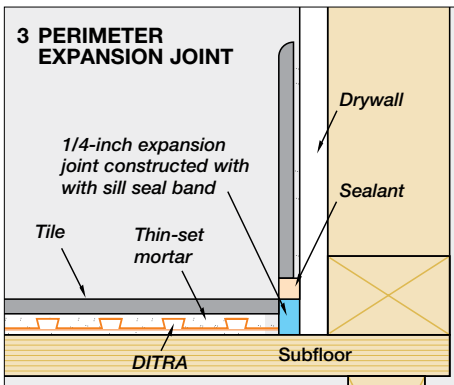

Perimeter Joints

Perimeter joints are provided at the outer edges of any tile installation to accommodate movements attributable to changes in moisture, temperature, and loading. See figures 1, 2, and 3.

If Schluter®-DILEX corner movement profiles will not be used, Schluter®-Systems recommends the use of sill seal (a compressible polyethylene gasket used to seal the gap between foundations and sill plates) as a quality control measure when providing perimeter movement joints. The sill seal band is placed against perimeter structures before any component of the tile assembly is installed, (e.g., Schluter®-DITRA, Schluter®-DITRA-XL, additional underlayments including self-leveling materials, mortar beds, etc. See figures 2 and 3). After the tile is installed and grouted, any excess sill seal material is cut away, leaving a movement joint with uniform width that is void of any mortar, grout, or other restraining materials that would render the joint ineffectual.

Surface Joints

Surface joints must be placed within the tiled surface regardless of substrate conditions. They provide for stress relief from movements in the tile field due to thermal and moisture expansion/contraction and loading. See figure 4.

Expansion Joints

Expansion joints permit both horizontal and vertical differential movements attributable to thermal and moisture expansion/contraction by providing a complete separation for the full depth of the slab to allow for free movement between adjoining parts of a structure or abutting surfaces. They are typically placed at columns, walls, and any other restraining surfaces. Expansion joints must be continued through the tile covering.

DITRA and DITRA-XL are separated at expansion joints and the joint is continued through the tile covering using DILEX surface movement profiles. When DITRA and DITRA-XL are used as waterproofing, the abutted sections must be covered with Schluter®-KERDI-FLEX or Schluter®-KERDI-BAND.

Cold Joints

Cold (construction) joints occur where two successive placements of concrete meet. True cold joints bond the new concrete to the old and do not allow movement. However, it takes extra care to accomplish this, so they are usually designed to act as expansion or control/contraction joints. Cold joints are treated in the same manner as expansion joints. See above.

Control/Contraction Joints

Control/contraction joints are designed to induce controlled cracking caused by drying and chemical shrinkage at preselected locations. They are typically formed by saw cutting, tooling, or through the use of inserts. DITRA and DITRA-XL are not separated at control/contraction joints; however, surface movement joints must be provided in the tile covering in accordance with the aforementioned guidelines. See also Surface Joints.

Structural or Seismic Joints

Regarding structural and seismic expansion joints, please contact Schluter®-Systems at 800-472-4588 (USA) or 800-667-8746 (Canada) for proper installation guidelines.

Note regarding residential applications

Due to the increased popularity of continuous tile installations (i.e., tile continuing from room to room on a given floor), movement joints have become both increasingly important and increasingly difficult to provide. For instance, consider the residential installation shown in Figure 5. It is almost certain that the homeowner will resist the idea of placing movement joints across any of the rooms shown in the figure, despite TCNA, TTMAC, and Schluter®-Systems guidelines. However, the need for movement joints in this installation is undeniable, given the extended size of the field. The question then becomes, "How does one provide the movement joints necessary to ensure a durable installation without compromising the aesthetic qualities of the continuous tile field?"

The easiest way to accomplish this goal is to begin by providing movement joints at the perimeter of the installation. Perimeter joints are absolutely necessary and do not interrupt the tile field. The next step would be to place movement joints at the thresholds between rooms or where a tiled hallway meets a larger tiled room. These locations are relatively inconspicuous and the lines formed by the movement joints are logical in that they reflect the natural perimeter of each room. Finally, determine if any other characteristics of the floor plan invite the placement of additional movement joints. In this example, the intersection of the nook area and kitchen/family room may be a reasonable choice.

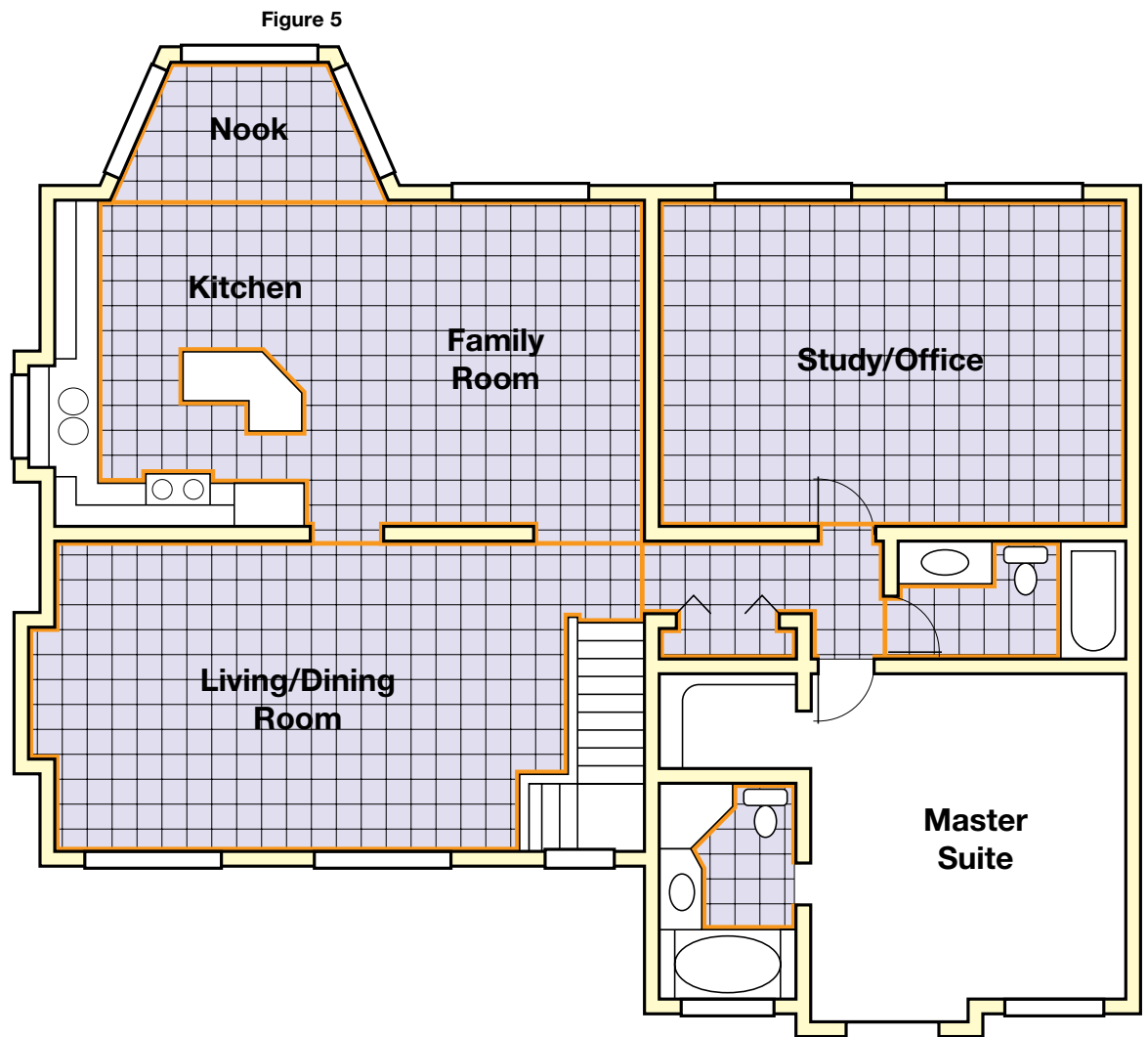

Schluter®-Systems understands that the tile setter must take into account the needs of his or her client in determining the placement of movement joints in a tile installation. For example, a client may not wish to interrupt a continuous tile field that spans multiple rooms. However, as indicated by the orange lines above, there are ways to meet industry guidelines that will serve to provide the client with a durable installation that remains aesthetically pleasing.

WOOD UNDERLAYMENT

Plywood/OSB underlayment installation guidelines

DISCUSSION

In some applications referenced in this Handbook, adding a layer of plywood or OSB before installing Schluter®-DITRA and the ceramic or stone tile covering is required to reduce deflection and curvature of the sheathing between the joists.

INSTALLATION GUIDE

Place underlayment panels (Exposure 1, plugged-face plywood or OSB of minimum 3/8" (10 mm) thickness) with long dimension perpendicular to floor joists such that the following conditions are met:

1. Abut all underlayment end joints at quarter points between joists.

Example: Abut underlayment panels on either side of the joist centerline at: 4" (102 mm) for 16" (406 mm) o.c. joists, 5" (127 mm) for 19.2" (488 mm) o.c. joists, or 6" (152 mm) for 24" (610 mm) o.c. joists (see figures 1 & 2).

Note: Underlayment end joints should be placed as far away from subfloor end joints as possible.

2. Underlayment to overlap edge joints of subfloor by 1/2 of the width of the subfloor panel (24" - 610 mm). At restraining surfaces, overlap may be less than 24" (610 mm) when the subfloor panel is less than 48" (1.2 m)-wide (see figure 1).
3. Gap underlayment panels 1/8" (3 mm) on all ends and edges, and 1/4" (6 mm) at perimeter walls, cabinetry, or other restraining surfaces.

Figures 1 & 2 – Typical Subfloor/Underlayment Detail (Not to Scale)

Figure 2

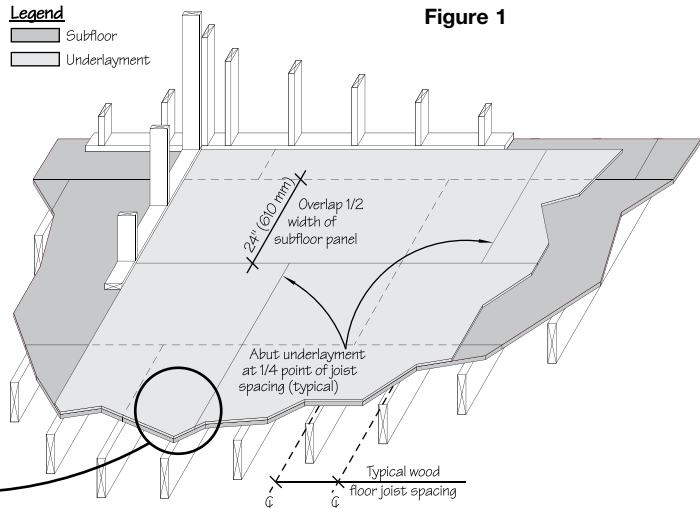
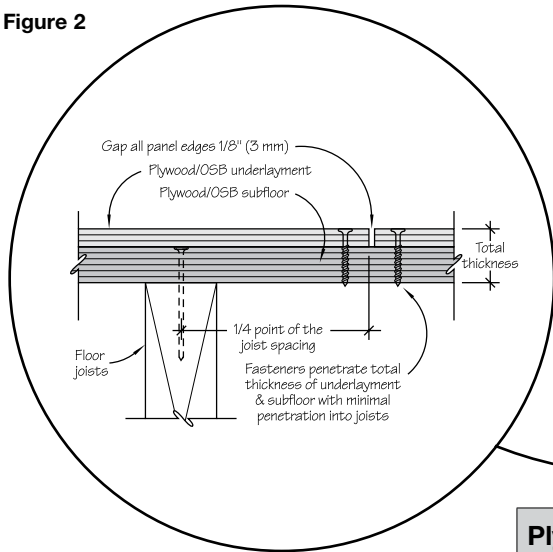

Plywood/OSB Type and Fastener Schedule Guidelines			
Plywood/OSB Grades	Plywood/OSB Thickness - in (mm)	Maximum On-Center Fastener Spacing - in (mm)	
		Panel Edges	Field
Exposure 1, plugged-face plywood or OSB	3/8 (10)	4 (102)	6 (152)
	1/2 (13)	4 (102)	6 (152)
	Greater than 1/2 (13)	6 (152)	6 (152)

The following guidelines must be followed when fastening underlayment panels:

1. Use ring shank nails (no staples) or wood screws (no drywall screws).
2. Fasteners must pass through entire thickness of underlayment and subfloor panels with minimal penetration into joists (see figure 2).

FINAL WORD

As stated previously, Schluter®-Systems requires that any underlayment panel must have a minimum thickness of 3/8" (10 mm). When in doubt, increase underlayment thickness.

INSTALLATION

Schluter®-DITRA and Schluter®-DITRA-XL

Easy Step-by-Step Installation

A step-by-step installation video is available. E-mail us at info@schluter.com or call us at 800-472-4588 (USA) or 800-667-8746 (Canada). To see a video clip, go to www.schluter.com.



Using a thin-set mortar that is suitable for the substrate, apply the thin-set mortar (**mixed to a fairly fluid consistency, but still able to hold a notch**).

▲ For DITRA use a 1/4" x 3/16" (6 mm x 5 mm) V-notched trowel, 5/16" x 5/16" (8 mm x 8 mm) V-notched trowel, or the DITRA trowel which features a 11/64" x 11/64" (4.5 mm x 4.5 mm) square-notched design.

▲ For DITRA-XL use a 1/4" x 1/4" (6 mm x 6 mm) square-notched trowel or the DITRA-XL trowel, which features a 1/4" x 1/4" (6 mm x 6 mm) square-notched design.



Apply DITRA or DITRA-XL to the floor, fleece side down. Solidly embed the matting into the bonding mortar using a float, screed trowel, or Schluter®-DITRA-ROLLER (please observe the open time of the bonding mortar).

When using the DITRA-ROLLER, place a weight (e.g., bag(s) of mortar/grout or box of tile) not to exceed 75 lbs on the DITRA-ROLLER shelf. Slowly move the roller from one end of the matting to the other, slightly overlapping successive passes.



Lift up a corner of the matting to check coverage. Proper installation results in full contact between the fleece webbing and the thin-set mortar. Simply about end and side sections of adjacent sheets.

Note: Coverage may vary with mortar consistency, angle at which the trowel is held, substrate flatness, etc. If full coverage is not achieved, remove and reapply, making sure to verify proper mortar consistency and application.



Tile can be installed over DITRA and DITRA-XL immediately; no need to wait for the mortar to cure. Fill the cut-back cavities with Schluter SET™, Schluter ALL-SET™, Schluter FAST-SET™, or unmodified thin-set mortar and comb additional mortar over the matting using a trowel that is appropriate for the size of the tile. Solidly embed the tiles in the setting material. Periodically remove and check a tile to ensure that full coverage is being attained. Back-buttering is a useful way to help ensure proper coverage, particularly when installing large-format tiles (e.g., 12" x 12" (305 mm x 305 mm) and larger).

ESTIMATED THIN-SET COVERAGE

To bond DITRA to the substrate, using the DITRA trowel: Use one 50 lb. (22.68 kg) bag of mortar per 150 ft² (10.7 m²).

To bond DITRA-XL to the substrate, using the DITRA-XL trowel: Use one 50 lb. (22.68 kg) bag of mortar per 100 ft² (9.3 m²).

To bond the tile to the DITRA, using a 1/4" x 3/8" (6 mm x 10 mm) square- or U-notched trowel: Use one 50 lb (22.68 kg) bag of mortar per 40 - 50 ft² (3.7 - 4.6 m²).

To bond the tile to the DITRA-XL, using a 1/4" x 3/8" (6 mm x 10 mm) square- or U-notched trowel: Use one 50 lb (22.68 kg) bag of mortar per 35 - 45 ft² (3.3 - 4.2 m²).

Waterproofing

The following steps are required for waterproofing only:



At the joints, fill the cut-back cavities with Schluter SET™, Schluter ALL-SET™, Schluter FAST-SET™, or unmodified thin-set mortar, approximately 8" (203 mm) wide, centered over the joint.



Comb additional Schluter SET™, Schluter ALL-SET™, Schluter FAST-SET™, or unmodified thin-set mortar over the joint using a 1/4" x 3/16" (6 mm x 5 mm) V-notched trowel or the Schluter®-KERDI trowel, which features a 1/8" x 1/8" (3 mm x 3 mm) square-notched design. Using the flat side of the trowel, firmly press the 5" (127 mm)-wide Schluter®-KERDI-BAND into the mortar to ensure 100% coverage and to remove excess mortar and air pockets.



At all wall junctions, apply KERDI-BAND as described in steps 1-3, ensuring a minimum of 2" overlap on to DITRA/DITRA-XL.

Notes

- ▲ KERDI-BAND must lap DITRA and DITRA-XL at seams and at floor/wall transitions by a minimum of 2" (50 mm) in order to maintain waterproof integrity.
- ▲ In some applications the vertical section of the floor/wall transition will not accept a bond to unmodified thin-set mortar. Connections to such elements can be achieved using Schluter®-KERDI-FIX or suitable trowel-applied waterproofing materials, such as those that require atmospheric moisture to cure (e.g., urethane sealant).

THIN-SET FACTS

Discussion of thin-set mortars and Schluter®-DITRA installations

Schluter®-Systems offers thin-set mortars designed for use with Schluter® membranes and boards. All Schluter®-Systems' thin-set mortars, including the Schluter ALL-SET™ and Schluter FAST-SET™ modified varieties, can be used to set tile over Schluter®-DITRA, DITRA-HEAT, KERDI, KERDI-BOARD, etc. non absorptive substrates. If Schluter® thin-set mortars are not used, we require unmodified thin-set mortar when setting ceramic or porcelain tile over DITRA.

QUESTION: Can ceramic tile, including porcelain tile, be set on DITRA with unmodified thin-set mortar?

ANSWER: YES. In fact, we recommend it. Here's why:

Portland cement-based unmodified thin-set mortars are dependent on the presence of moisture for hydration in order to gain strength. Since DITRA is impervious, it does not deprive the mortar of its moisture. This allows the cement to properly hydrate, resulting in a strong, dense bond coat. In fact, after the mortar has reached final set (usually within 24 hours), unmodified thin-set mortars achieve higher strengths when cured in continually moist conditions.

QUESTION: Can ceramic tile, including porcelain tile, be set on DITRA with latex-modified thin-set mortar?

ANSWER: In general, we DON'T recommend it. Here's why:

Latex-modified mortars must dry for the polymers to coalesce and form a hard film in order to gain strength. When sandwiched between two impervious materials such as DITRA and ceramic tile, including porcelain tile, drying takes place very slowly through the open joints in the tile covering. [According to the TCNA Handbook for Ceramic, Glass, and Stone Tile Installation, this drying period can fluctuate from 14 days to over 60 days, depending on the geographic location, the climatic conditions, etc.]. Therefore, extended cure times could be required before grouting if using modified thin-set mortars between DITRA and ceramic tile, including porcelain tile. If extended cure times were not observed, the results could be unpredictable.

QUESTION: Can Schluter ALL-SET™ and Schluter FAST-SET™ modified thin-set mortars be used to set tile over Schluter boards and membranes?

ANSWER: Yes.

All Schluter® thin-set mortars, including the Schluter ALL-SET™ and Schluter FAST-SET™ modified varieties can be used to set tile over DITRA, DITRA-HEAT, KERDI, KERDI-BOARD, etc. non absorptive substrates.

QUESTION: How is this possible?

ANSWER: The key is predictability.

Schluter Systems' modified thin-set mortars have been specifically formulated to set and gain strength in a timeframe that fits typical installation practice, even when sandwiched between Schluter® membranes or boards and porcelain tile. The proportions of cement, water-retention agents, polymers, and other components in the mixtures were balanced to ensure that extended dry times are not required. This was validated through both laboratory and practical testing. Now, the installer can select from either unmodified or modified thin-set mortar to install tiles within our systems according to his or her preference.

QUESTION: Why did Schluter Systems change its position on thin-set mortar?

ANSWER: We haven't changed our position on thin-set mortar use within our systems.

Developing our own setting materials has given us the ability to guarantee consistently positive results. And since we control the formulas, we can be sure no changes will be made that have a negative impact on setting times and strength gain in these environments.

QUESTION: Does this mean I can use other manufacturers' modified thin-set mortars to install tile over Schluter boards and membranes?

ANSWER: No.

Our position on thin-set mortar use within our systems in general has not changed. We have no control over the formulation of other manufacturers' products and therefore cannot guarantee consistently positive results with their modified thin-set mortars.

QUESTION: Can I still use other manufacturers' unmodified thin-set mortars to install tile over Schluter boards and membranes?

ANSWER: Yes.

We still warrant the use of unmodified thin-set mortar meeting ANSI A118.1 to install tile within our systems because we have confidence in the performance of this product category. This is based on the science of cement hydration and years of positive testing and field experience.

Please note, if Schluter® thin-set mortars are used with Schluter membranes an extended system warranty is available.

ADDITIONAL NOTES

Pre-mixed thin-set mortars and mastics are not suitable for use in conjunction with DITRA and DITRA-XL.

Remember, the type of mortar used to apply DITRA depends on the type of substrate. The mortar must bond to the substrate and mechanically anchor the fleece on the underside of the DITRA. For example, bonding DITRA to wood requires latex-modified thin-set mortar. When bonding DITRA to particularly dry, porous concrete with unmodified thin-set mortar, the slab should be moistened to saturate the concrete and help prevent premature drying of the mortar. Excess or standing surface water must be removed prior to installation. Additionally, all mortars (modified and unmodified) have an acceptable temperature range that must be observed during application and curing.

THIN-SET DISCUSSION

Evaluation of mortar types used with Schluter®-DITRA

As stated previously in this Handbook, Schluter®-Systems recommends the use of unmodified thin-set mortar between **DITRA** and the ceramic or porcelain tile covering. In this section, we will address concerns regarding the use of unmodified mortar over DITRA and provide insight into the overall function of the tile assembly using experimental data. The Tile Council of North America was contracted to perform independent testing of all experimental setups described hereafter.

A popular misconception in the tile industry is that porcelain tile cannot be bonded using unmodified mortar. To show that unmodified mortar will provide the necessary performance in DITRA installation systems, the following tests were performed. First, unmodified mortars from two different manufacturers were used to bond porcelain tile to DITRA over a single layer of 3/4" plywood with joists spaced at 19.2" o.c. The two installations were tested according to the ASTM C627 "Standard Test Method for Evaluating Ceramic Floor Tile Installation Systems Using the Robinson Type Floor Tester" and produced ratings of *heavy* and *light*. *Heavy* indicates a performance level acceptable for shopping malls, stores, commercial kitchens, work areas, laboratories, auto showrooms and service areas, shipping/receiving, and exterior decks, while *light* indicates a performance level acceptable for light commercial use in office space, reception areas, kitchens, and bathrooms. Given that the test assemblies only utilized a single layer of plywood, these high-performance ratings demonstrate that unmodified mortar can provide a secure bond even over a bending and deflecting substrate. Tiles were removed from each of the ASTM C627 specimens after the Robinson test was complete, and then used to evaluate shear bond strength between the unmodified mortar and the tile. Test results are summarized in the table below.

Mortar Type (Applicable ANSI Standard)	Test Report Number	ASTM C627 Test Rating*	Test Report Number	Shear Test Results† (psi)	
				Specimens:	Average:
Manufacturer 1 Unmodified (A118.1)	TCA-046-03 (B)	Heavy (13 cycles)	TCA-073-03	Specimens:	327, 267, 267, 246
				Average:	277
Manufacturer 2 Unmodified (A118.1)	TCA-126-03 (A)	Light (9 cycles)	TCA-186-03	Specimens:	425, 381, 275, 377
				Average:	365

*Test Setup:

1. 2" x 2" joists spaced 19.2" o.c.
2. APA-rated "Exposure 1" tongue-and-groove plywood subfloor; 3/4" thickness
3. Spray-dried latex-modified mortar in Test TCA-046-03 and liquid-emulsion latex-modified mortar in Test TCA-126-03 (ANSI A118.4)
4. Schluter®-DITRA mat
5. Unmodified mortar, as indicated in table above (ANSI A118.1)
6. 12" x 12" porcelain tile; 3/8" nominal thickness
7. Sanded, spray-dried latex-modified portland cement grout (ANSI A118.7)

† Tile samples removed from ASTM C627 test specimens and evaluated for shear bond strength between mortar and tile

Tests were also performed on DITRA assemblies using unmodified thin-set mortar over concrete according to ASTM C627. The two assemblies produced ratings of *Extra Heavy*, indicating a performance level acceptable for extra heavy and high impact use in food plants, dairies, breweries, and kitchens, and *Light*, indicating a performance level suitable for light commercial use in office space, reception areas, kitchens, and bathrooms. Variation in the performance levels achieved is attributable to the different tile used. Test results are summarized in the table below.

Substrate	Mortar Type (Applicable ANSI Standard)	Tile	Grout (Applicable ANSI Standard)	ASTM C627 Test Rating	Test Report Number
Concrete	Unmodified (A118.1)	12" x 12" porcelain; 5/16" nominal thickness	Polymer Modified Cement Grout (A118.7)	Extra Heavy (14 cycles)	TCNA-039-06
Concrete	Unmodified (A118.1)	2" x 2" porcelain; 1/4" nominal thickness	Polymer Modified Cement Grout (A118.7)	Light (6 cycles)	TCNA-057-06

Given concern over freeze/thaw performance of unmodified mortar, the next set of tests included shear bond tests of porcelain tile bonded to concrete with and without DITRA after exposure to freeze-thaw cycles in accordance with ANSI A118.4 (F5.2.6). An unmodified mortar was used in one installation, while a liquid-emulsion latex-modified mortar from the same manufacturer was used in the other. It should be noted that when used between two impervious materials, such as porcelain tile and DITRA, latex-modified mortars must be afforded extended drying times. According to the *TCNA Handbook for Ceramic, Glass, and Stone Tile Installation*, the necessary drying period can fluctuate from 14 days to over 60 days when using latex-modified mortar. Since unmodified mortars do not require a drying period (and actually benefit from continued water presence), they allow for normal use of the tile installation in a fraction of the time and, as shown in the test data in the table below, provide more than adequate performance.

Mortar Type (Applicable ANSI Standard)	Shear Test Results‡ (psi) Test Report TCA-145-03		
	Tile Bonded to Concrete (ANSI A118.4)⁻	Tile and DITRA Bonded to Concrete (ANSI A118.10)°	
Manufacturer 1 Unmodified (A118.1)	208	Specimens:	66, 61, 70, 62
		Average:	65
Manufacturer 1 Liquid-Emulsion Latex-modified (A118.4)	199	Specimens:	53, 57, 58, 75
		Average:	61

‡ All specimens subjected to freeze/thaw cycles in accordance with ANSI A118.4 (F5.2.6)

⁻ ANSI A118.4 requires minimum shear bond strength of 175 psi

° ANSI A118.10 requires minimum shear bond strength of 50 psi

TESTING & CERTIFICATIONS

Product Evaluation

Schluter®-Systems is committed to providing reliable installation systems for ceramic and stone tile. As part of this commitment, we have invested considerable resources in testing our products and obtaining certifications where applicable to provide our customers and local code officials with relevant data that supports the efficacy of our systems. All the testing referenced below was performed by independent laboratories.

Uncoupling and Support/Load Distribution

The method used to establish the overall performance of a tile assembly under loading is the ASTM C627 "Standard Test Method for Evaluating Ceramic Floor Tile Installation Systems Using the Robinson Type Floor Tester." The assembly is tested in cycles using a loaded, revolving carriage. Load, wheel hardness, and number of revolutions vary with each cycle. Once a specified level of damage is exceeded, the test is stopped. The Tile Council of North America (TCNA) Handbook for Ceramic, Glass, and Stone Tile Installation assigns performance levels to an assembly based on the number of cycles successfully completed. The ratings include residential, light, moderate, heavy, and extra heavy, in order of improving performance.

Report Number	Substrate	Joist Spacing	Tile	Rating
Schluter®-DITRA				
TCA-046-03 (B)	Plywood	19.2" o.c.	12" x 12" porcelain	Heavy (13 cycles)
TCA-126-03 (A)	Plywood	19.2" o.c.	12" x 12" porcelain	Light (9 cycles)
TCA-130-04 (C)	OSB	19.2" o.c.	6" x 6" porcelain	Heavy (12 cycles)
TCA-130-04 (A)	OSB	19.2" o.c.	3" x 3" porcelain	Light (7 cycles)
TCNA-039-06	Concrete	N/A	12" x 12" porcelain	Extra Heavy (14 cycles)
TCNA-057-06	Concrete	N/A	2" x 2" porcelain	Light (6 cycles)
Schluter®-DITRA-XL				
TCNA-153-08	Plywood	24" o.c.	6" x 6" porcelain	Extra Heavy (14 cycles)
TCNA-303-06	Plywood	24" o.c.	12" x 12" porcelain	Heavy (12 cycles)

Assembly Notes:

1. All plywood and OSB subfloors were 23/32" (3/4" nom.) -thick
2. DITRA and DITRA-XL bonded to plywood/OSB with modified thin-set mortar (ANSI A118.11)
3. DITRA bonded to concrete with unmodified thin-set mortar (ANSI A118.1)
4. Tile bonded to DITRA and DITRA-XL with unmodified thin-set mortar (ANSI A118.1)
5. Polymer-modified cement grout (ANSI A118.7)

The test results above demonstrate that Schluter®-DITRA and -DITRA-XL perform extremely well under load while at the same time providing flexibility within the shear plane.

Waterproofing

DITRA and DITRA-XL provide reliable waterproofing in interior and exterior applications. The products have been found to meet or exceed the requirements of the American National Standard Specifications for Load Bearing, Bonded, Waterproof Membranes for Thin-set Ceramic Tile and Dimension Stone Installation A118.10. Schluter®-DITRA and DITRA-XL are also listed by cUPC® and have been evaluated by ICC-ES (Report No. ESR-2467 and PMG-1204).

Vapor Management

The free space under the DITRA matting allows the substrate to breathe, while the material composition provides for a very low water vapor permeance, which prevents any significant vapor intrusion in the tile assembly from below.

Property	Test Method	Performance
Water vapor permeance	ASTM E96-00 (water method at 73° F and 50% RH)	0.006 perms

The result is that DITRA and DITRA-XL effectively manage vapor and prevent damage to the tile covering as a result.

Green Building

DITRA and DITRA-XL were evaluated according to the "Standard Method for the Testing and Evaluation of Volatile Organic Chemical Emissions from Indoor Sources Using Environmental Chambers, Version 1.1" for California Specification 01350 and found to comply with the VOC requirements. California Specification 01350 is referenced by various green building standards and rating systems.

HOW DOES IT WORK?

Explanation of how Schluter®-DITRA functions

To understand how the DITRA system works, it is important to first understand what a tile assembly is, how it functions, and how stresses occur within the assembly. A tile installation is a composite assembly that consists of layered components (underlayers, bonding mortars, tile, etc.). The primary sources of stress in this composite system are movements due to loading, changes in temperature, and changes in moisture content (either in the substructure or in the components of the tile assembly, including the tile itself). When an installation is subjected to these movements, compressive and tensile stresses develop within the assembly and interact to produce shear stresses at the interfaces between the layered components. Therefore, a tile assembly must be able to perform well under load and, at the same time, provide flexibility within the shear plane.

The method used to establish the overall performance of a tile assembly under loading is the ASTM C627 “Standard Test Method for Evaluating Ceramic Floor Tile Installation Systems Using the Robinson Type Floor Tester.” The assembly is tested in cycles using a loaded, revolving carriage. Load, wheel hardness, and number of revolutions vary with each cycle. Once a specified level of damage is exceeded, the test is stopped. The Tile Council of North America (TCNA) Handbook for Ceramic, Glass, and Stone Tile Installation assigns performance levels to an assembly based on the number of cycles successfully completed. The ratings include *residential*, *light*, *moderate*, *heavy*, and *extra heavy*, in order of improving performance.

The TCNA conducted the tests shown below, which included a single layer of plywood (3/4" thick) over joists spaced at 19.2" o.c., DITRA bonded using modified thin-set mortar (ANSI A118.4), 12" x 12" porcelain tile (3/8" thick) bonded using unmodified thin-set mortar (ANSI A118.1), and modified portland cement grout (ANSI A118.7).

Test Report Number	Number of Cycles Passed	Rating
TCA-046-03 (B)	13	Heavy
TCA-126-03 (A)	9	Light

The two installations produced ratings of *heavy* and *light*, according to the TCNA Handbook for Ceramic, Glass, and Stone Tile Installation. “Heavy” indicates a performance level acceptable for shopping malls, stores, commercial kitchens, work areas, laboratories, auto showrooms and service areas, shipping/receiving, and exterior decks, while “light” indicates a performance level acceptable for light commercial use in office space, reception areas, kitchens, and bathrooms.

Given that the test assemblies consisted of only a single layer of plywood over joists spaced at 19.2" o.c. (a bending and deflecting substrate), these ratings demonstrate that DITRA performs extremely well under load while at the same time providing flexibility within the shear plane.



DITRA provides uncoupling (geometric flexibility) through its open rib structure, which allows for in-plane movement that effectively neutralizes the differential movement stresses between the substrate and the tile.

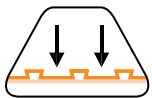

When placed on a solid foundation, columns or pillars can support tremendous loads. The same physical principle applies to DITRA installations. Column-like mortar structures are formed in the cutback cavities of the matting. Loads are transferred from the tile covering through these column-like mortar structures to the substrate. Since mortar has a very high compressive strength, DITRA becomes virtually incompressible within the tile assembly and, therefore, doesn't sacrifice load-distribution capabilities of the system.

This flexibility is readily apparent when the overall DITRA assembly is subjected to shear testing. In the tests shown below, porcelain tile was bonded to concrete using unmodified thin-set mortar meeting ANSI A118.1. One specimen included DITRA, while the other did not. The results show that the amount of stress developed in the system when the tile layer is displaced is significantly reduced through the inclusion of DITRA, which is due to the product's flexibility in the shear plane.

Assembly	Average Maximum Shear Stress (psi)
Tile over concrete	208
Tile and DITRA over concrete	65

Tile has been successfully installed for thousands of years by incorporating an uncoupling layer, or forgiving shear interface, between the tile assembly and the substrate. This practice has evolved from the sand-strata method (tile set in mortar over a layer of tamped sand) to the unbonded mortar bed method (tile set in mortar over a cleavage membrane). However, this alone does not ensure a high-performance tile installation. The tile covering must be well supported so that loads can be distributed through the assembly to the substructure without damaging the tile covering. Therefore, a viable tile assembly must be designed to incorporate both support/load distribution of the tile layer and flexibility within the shear plane (e.g., a traditional unbonded mortar bed allows for flexibility at the shear plane through a cleavage membrane, but still provides a solid base for the tile layer).

Since DITRA utilizes geometric flexibility in the shear plane rather than material flexibility, the advantages of uncoupling are achieved without sacrificing load-distribution capabilities of the tile assembly. Thus, it is the combination of geometric flexibility in the shear plane and support in the normal direction that allows DITRA to protect the tile layer from stresses due to loading and changes in temperature and moisture.

NATURAL STONE

Discussion of natural stone and single-layer wood subfloors

Natural stone is a product of nature with a wide variety of colors, patterns, and textures that come together to distinguish it as one of the premiere surface coverings available on the market. Some of stone's characteristics, which add to its beauty and uniqueness, are veins, fissures, starts, and dry-seams. While these characteristics enhance its aesthetic appeal, they're also indicators that point to the inherent variability of the flexural strength of natural stone, which can have detrimental effects on serviceability. This variability is underscored by examining the range of typical flexural (bending) strengths of ceramic tile compared to the range of strength for some common natural stones.

Schluter®-Systems contracted the Tile Council of North America (TCNA) to perform flexural strength testing on various commercially available ceramic tiles and dimension stones guided by the ASTM C880 Standard Test Method for Flexural Strength of Dimension Stone. Five samples of each tile and stone were tested, with the minimum recorded values displayed in the figure below. We have chosen to show only minimum values since these represent the weakest samples, which would be most prone to cracking in service over a bending substrate.

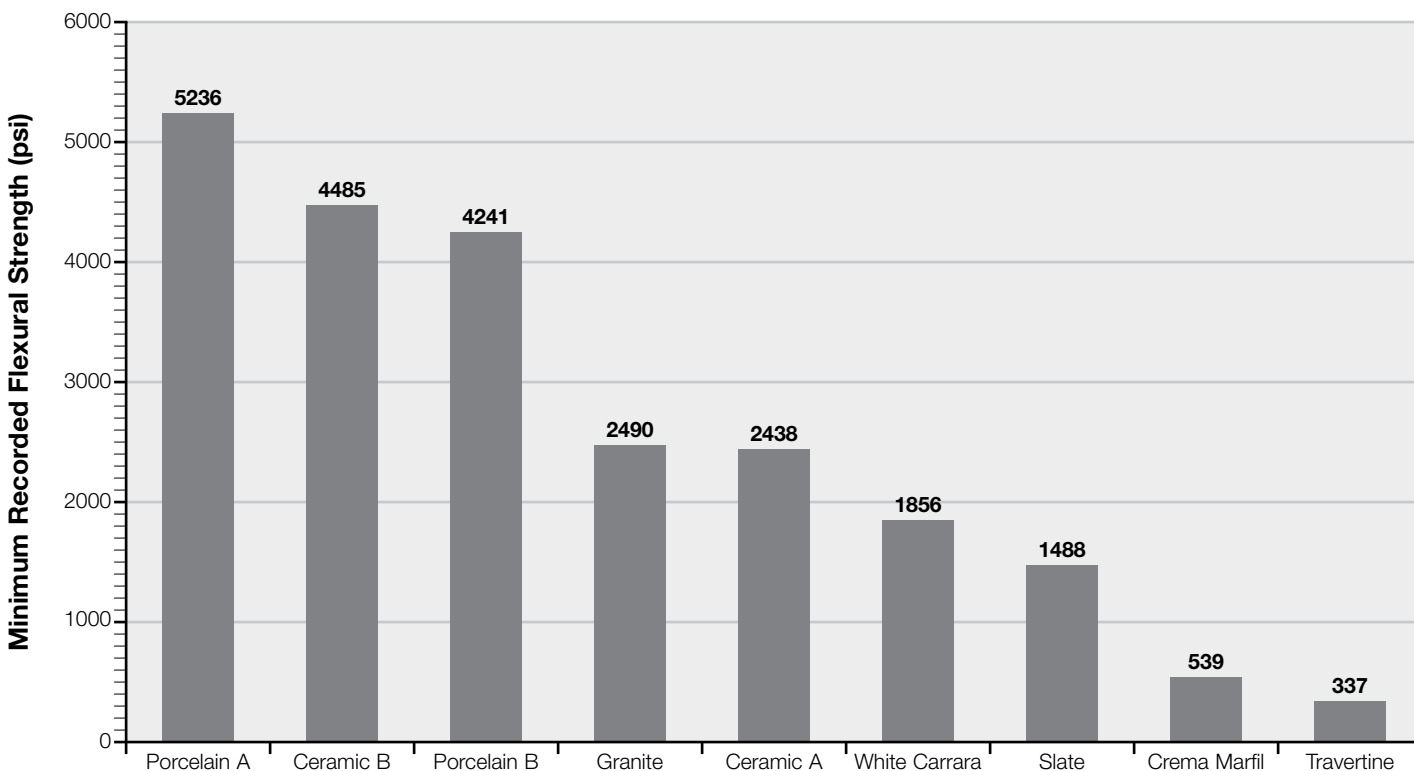

It is clear from the figure that the minimum recorded flexural strengths of these dimension stones tend to be significantly less than those of the ceramic tiles. In some cases, the differences are dramatic. For example, the minimum recorded flexural strength of the weakest travertine sample (337 psi) was only 14% of the minimum flexural strength of the weakest ceramic sample (2438 psi). In other words, the weakest ceramic sample was more than 7 times as strong as the weakest travertine sample. As another example, the minimum recorded flexural strength of the weakest porcelain sample is more than 12 times as strong as the minimum recorded flexural strength of the weakest travertine sample.

Q. Why does Schluter®-Systems recommend a double-layer wood floor for installing natural stone over DITRA and DITRA-XL?

A. There are three principle reasons: 1) As illustrated above, the fact that most stone products have a minimum flexural strength that is substantially lower than what is typical for ceramic tile; 2) Stones are products of nature and complex heterogeneous materials with naturally occurring regions of discontinuity, such as veins and fissures. Such features can be weaker than the surrounding stone fabric and act as "stress risers," concentrating bending stresses within the region of discontinuity; and 3) When wood floor assemblies are subjected to forces such as loading – both live and dead loads – they produce flexural stresses in the surface covering which can cause weak and brittle materials to break or crack.

Engineering mechanics as well as field observations show that the location of maximum flexural stresses in the floor assembly is directly over the floor joists and at seams in the subfloor panels. Therefore, we recommend double-layer wood floors when installing natural stone in order to increase the stiffness of the sheathing assembly and position underlayment seams away from the joists to minimize flexural stresses in the stone covering directly above the joists and at seams. Refer to page 18 for underlayment installation guidelines. For more information on the development of these guidelines, please refer to the article titled "Position of Underlayment to Prevent Cracked Tile and Grout" on our website at www.schluter.com/schluter-us/en_US/articles.

Q. What distinguishes DITRA-XL from DITRA?

A. Since the uncoupling function of DITRA is founded on its geometric flexibility to provide a forgiving shear plane, increasing the height of the product produces additional protection against stresses being transferred between the tile and supporting substrate. Testing reveals that this increase is significant.

Four assemblies incorporating natural stone installed with DITRA-XL over single-layer plywood subfloors were tested according to the ASTM C627 Standard Test Method for Evaluating Ceramic Floor Tile Installation Systems Using the Robinson Type Floor Tester as shown below.

Joist Spacing	Stone	ASTM C627 Test Results	Rating	TCNA Test Report Number
19.2" o.c.	White Carrara	12 cycles	Heavy	TCNA-121-07 (A)
24" o.c.	White Carrara	7 cycles	Light	TCNA-121-07 (B)
24" o.c.	Crema Marfil	5 cycles	Residential	TCNA-441-07
24" o.c.	Travertine	5 cycles	Residential	TCNA-441-07

Test Setup:

1. 2" x 2" joists
2. APA-rated "Exposure 1" tongue-and-groove plywood subfloor; 23/32" (3/4" nom.) thickness
3. Latex portland cement mortar (ANSI A118.11)
4. Schluter®-DITRA-XL
5. Unmodified thin-set mortar (ANSI A118.1)
6. Stone (12" x 12" x 3/8" nom. for each type)
7. Polymer-modified cement grout (ANSI A118.7)

These test assemblies represent demanding conditions, given the bending and deflection of the single-layer plywood subfloor under loading and keeping in mind the lower flexural strengths of these types of stones. The results indicate that DITRA-XL provides superior movement accommodation to limit stress transfer and protect the natural stone surface covering against damage.

It should be noted that one limitation of the ASTM C627 test is that test specimens do not include seams or butt joints between subfloor panel ends as would be present in an actual floor construction. Subfloor butt joints are located in areas of maximum bending flexural stress (on the joists).

Q. Then why doesn't Schluter®-Systems warranty DITRA-XL for stone applications over single-layer wood subfloors?

A. Schluter®-Systems acknowledges that, in many instances, the market is requesting stone applications over single-layer wood subfloors. This is due in large part because customers want even transitions to adjacent flooring surfaces and don't want the additional cost of installing another layer of wood. Schluter®-Systems has responded to this request with DITRA-XL. In our opinion, based on laboratory testing and field experience, DITRA-XL is the most reliable system for installing natural stone over single-layer wood subfloors on the market today.

Still, the inherent variability in the flexural strength of natural stone in conjunction with the dynamics of single-layer wood subfloors can produce substantial uncertainty in predicting the in-service performance of the stone covering. As such, Schluter®-Systems cannot warranty stone coverings over single-layer wood subfloors.

When the risks associated with natural stone and a single-layer wood application are unacceptable to the owner, building design professional, general contractor, and/or installer, then detail D-W-S is recommended, which includes the use of a plywood/OSB underlayment (double-layer wood system) in addition to the DITRA or DITRA-XL uncoupling membrane. Double-layer wood systems using DITRA or DITRA-XL for supporting stone are covered by the DITRA & DITRA-XL warranty (see page 34).

SOUND CONTROL

Discussion of sound control in conjunction with ceramic & stone tile

Controlling sound transmission through floor/ceiling assemblies in multi-story construction can present challenges to architects and design professionals, particularly when hard surface coverings, including ceramic and stone tiles, are used. This is because sound control materials tend to be compressible and may not provide adequate support for the tile layer in thin-set applications. However, there are practical methods that allow for the use of tile and stone while providing sound transmission control.

Sound transmission categories, evaluation, and code requirements

The first category is airborne sound, such as speaking, music, etc. Airborne sound transmission is measured using standard test methods. For example, the ASTM E90 and ASTM E336 test methods are commonly used for laboratory and field measurement of airborne sound transmission, respectively. The results from these tests are then used to calculate a single-number rating per ASTM E413 that is called sound transmission class (STC) or field sound transmission class (FSTC).

The second category is impact sound, such as foot traffic, dropped items, etc. The ASTM E492 and ASTM E1007 test methods are commonly used for laboratory and field measurement of impact sound transmission, respectively. The results from these tests are then used to calculate a single-number rating per ASTM E989 that is called impact insulation class (IIC) or field impact insulation class (FIIC). The ASTM E2179 test method was developed to provide a means of evaluating the flooring assembly's contribution to a concrete floor. The contribution of the flooring assembly to the IIC of the slab is calculated and reported as the Δ IIC (delta IIC).

Building codes typically contain requirements for both STC and IIC. For example, the International Building Code (IBC) calls out minimum values of 50 for STC and IIC or 45 for FSTC and FIIC as an alternative to laboratory testing. The International Residential Code (IRC) calls out minimum values of 45 for STC and IIC. Condominium associations may have their own minimum requirements for sound attenuation as well.

Factors affecting performance

Airborne sound transmission through floor/ceiling assemblies can be reduced effectively by increasing the mass of the assembly and introducing suspended ceilings with sound insulation in the cavities. In general, STC ratings are largely independent of the choice of floor covering. Furthermore, the methods used to improve STC ratings as called out above do not have adverse effects on the floor covering. Thus, airborne sound transmission control is not a challenge to be addressed by the tile industry.

Impact sound control performance is dependent upon both the floor/ceiling structure and the floor covering itself. In general, impact sound control with hard surface coverings is best achieved with floating systems that incorporate resilient layers.

A 6" (152 mm)-thick concrete slab will produce an IIC rating of approximately 28 without the floor covering or ceiling assembly. The direct application of tile will not significantly improve the IIC rating. When flexible underlayments (membranes) are used in a thin-set assembly the IIC rating can be improved, though the use of additional sound attenuation methods (e.g., sound-rated ceilings) are typically necessary to meet required minimums. As resilient layers within a thin-set assembly are made thicker and more flexible sound control tends to improve, but load-bearing capacity is reduced. This is the inherent limitation of thin-set assemblies for sound control. However, relatively thick and resilient sound underlayments can be combined with a load-distribution layer (e.g., mortar bed, lightweight concrete topping, poured gypsum underlayment) to provide excellent results (sound control meeting code minimums) without a sound-rated ceiling and still provide good support for the tile assembly. For example, research has shown that a 1-3/8" (35 mm)-thick concrete topping over 1" (25 mm)-thick mineral fiber board on a 6" (152 mm)-thick concrete slab will produce an average IIC rating of approximately 60 to 65 without the floor covering or ceiling assembly, which far exceeds code minimums.

Wood-frame construction typically consists of a plywood or OSB subfloor supported on joists with gypsum board used to finish the ceiling underneath. The first step in improving impact sound control is to ensure that the gypsum board ceiling is not directly attached to the joists. Resilient channels are used to provide isolation between the gypsum board and the joists. Sound insulation batts are placed in the cavities between joists as well. This type of assembly will produce an IIC rating of approximately 45 before the flooring assembly is installed. This rating can be improved by increasing the mass of the assembly (e.g., adding another layer of gypsum board to the ceiling or plywood/OSB to the floor). The direct application of tile over the subfloor can actually lower the IIC rating of this assembly. Using flexible underlayments may mitigate this effect or even improve the IIC rating, but currently there is no standard test method available to quantify the contribution of a flooring assembly to wood-frame construction in general. Again, the use of relatively thick and resilient sound underlayments can be combined with a load-distribution layer to provide significant sound control and a solid base for tile installation.

Schluter®-DITRA

Schluter®-Systems has never promoted DITRA as a sound control system. However, DITRA provides a degree of sound attenuation similar to various thin-set sound control membranes. DITRA and ceramic tile were tested* over a 6" (152 mm)-thick concrete slab and the measured IIC rating of this assembly was 10 points greater than the measured IIC rating of the bare slab (IIC bare slab = 28, IIC slab w/DITRA and tile = 38). This level of performance is not sufficient to meet typical code requirements without additional sound control measures. As discussed above, the use of a sound control underlayment in combination with a load-distribution layer such as a mortar bed, lightweight concrete, or gypsum concrete can significantly improve the IIC rating of the assembly. Sound-rated ceilings can improve the IIC rating as well.

* Please note that this testing was performed prior to the approval of the ASTM E2179 standard test method and used a smaller specimen size (4 ft x 4 ft) than required by existing sound control test method standards.

Installation Considerations

In laboratory testing, sound energy transmission is effectively directed through the test specimen only, with negligible transfer through other paths. In other words, the values recorded provide an accurate picture of the sound control characteristics of the test specimen itself. However, in construction, floor/ceiling assemblies and wall assemblies are connected to form the final structure and there is potential for interaction between these elements. Floor/ceiling assemblies may not perform as expected in the field with respect to both airborne and impact sound control if they are not isolated from adjacent walls to prevent sound energy transfer. Thus, perimeter joints serve to accommodate expansion of the tile assembly and prevent "flanking" sound transfer. Schluter®-Systems provides a range of prefabricated movement joint profiles that can be used to limit movement stresses due to changes in moisture content, temperature, and loading and limit sound energy transfer.

PRODUCT SELECTION

Choosing between Schluter®-DITRA and DITRA-XL

How Do I Choose Between DITRA and DITRA-XL?

Schluter uncoupling membranes provide the four essential functions for successful tile installation over a wide range of substrates, including plywood/OSB, concrete, gypsum, heated floors, etc. The choice between using DITRA or DITRA-XL depends on the nature of the particular project or application. The following points will help differentiate between the two products.

DITRA

- Minimizes tile assembly thickness and reduces transitions to lower surface coverings (e.g., carpet, engineered wood, and vinyl)
- Only 1/8" (3 mm)-thick – provides the thinnest possible assembly without sacrificing performance

DITRA-XL

- Allows for ceramic tile application over single layer plywood/OSB subfloors on joists spaced at 24" (610 mm) o.c.
- 5/16" (7 mm)-thick – creates an even transition between typical 5/16" (7 mm)-thick tile and 3/4" (19 mm)-thick hardwood flooring

Even Transitions to Hardwood Flooring

In many thin-set ceramic tile applications, one of the goals is to minimize the thickness of the assembly to reduce height transitions from the tile to other floor coverings such as carpet, engineered wood, or vinyl. At 1/8" (3 mm)-thick, DITRA accomplishes this goal while providing the four essential functions for successful tile installations. Schluter floor profiles finish and protect tile edges at these transitions to complete the installation. However, where ceramic tile meets 3/4" (19 mm)-thick hardwood, minimizing the thickness of the tile assembly can result in a height transition up to the hardwood. On various projects, our customers began using two layers of DITRA to solve this problem. However, they requested a better solution.

Research and Development

Since the uncoupling function is based on the geometric configuration of the product, we recognized that increasing the thickness of DITRA would result in increased movement accommodation. When the new product was tested, it became clear that the increase was significant. For results of the DITRA-XL ASTM C627 testing, please see page 22.

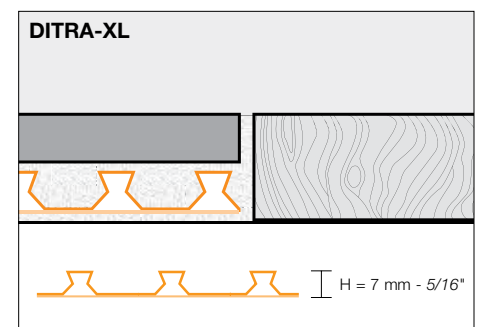
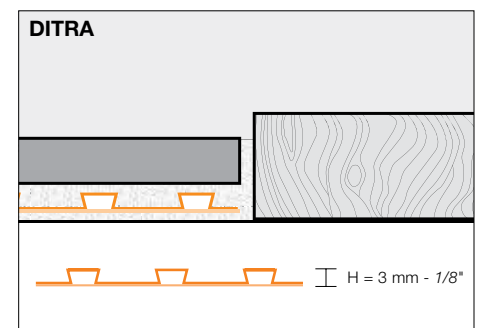

PRODUCT & ORDERING INFO

The ordering information for the **Schluter®-DITRA**, **Schluter®-DITRA-XL** and **Schluter®-KERDI** components outlined in this Handbook is located below. For technical support, Illustrated Price List, or to receive additional information on our complete product line, please call **1-800-472-4588 (USA)** or **1-800-667-8746 (Canada)**, or visit our comprehensive website at **www.schluter.com**.

Schluter®-DITRA

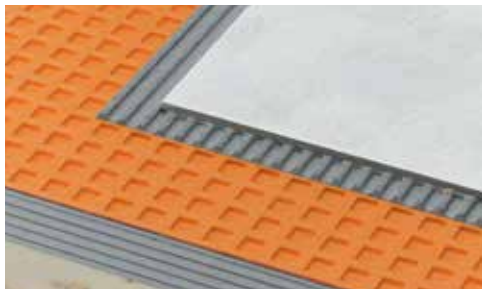

DITRA is a pressure-stable polyethylene membrane, vacuum-formed in a cutback grid design, with an anchoring fleece laminated to its underside. DITRA is 1/8" (3 mm) in height and emits zero VOC.

Schluter®-DITRA	
Uncoupling and waterproofing membrane (1/8" - 3 mm thick)	
Item No.	Dimensions
DITRA 5M	3' 3" x 16' 5" = 54 ft ² (1 m x 5 m = 5 m ²)
DITRA 150	3' 3" x 45' 9" = 150 ft ² (1 m x 14 m = 14 m ²)
DITRA 30M	3' 3" x 98' 5" = 323 ft ² (1 m x 30 m = 30 m ²)

Schluter®-DITRA-XL

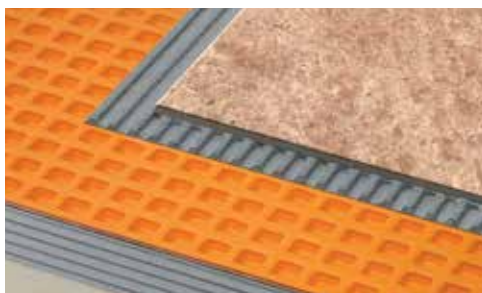

DITRA-XL is a pressure-stable polyethylene membrane, vacuum-formed in a cutback grid design, with an anchoring fleece laminated to its underside. DITRA-XL is 5/16" (7 mm) in height and emits zero VOC.

Schluter®-DITRA-XL	
Uncoupling and waterproofing membrane (5/16" - 7 mm thick)	
Item No.	Dimensions
DITRA-XL/175	3' 3" x 53' 3" = 175 ft ² (1 m x 16.25 m = 16.25 m ²)

Schluter®-KERDI-BAND



KERDI-BAND is a waterproofing strip used to seal butt joints and floor/wall connections with the KERDI and DITRA membranes, as well as profile connections with the Schluter®-BARA balcony edging profile series.

Schluter®-KERDI-BAND			
Waterproofing strip			
Item No.	Width	Length	Thickness
KEBA 100/125/5M	5" - 125 mm	16' 5" - 5 m	4 mil
KEBA 100/125/10M	5" - 125 mm	33' - 10 m	4 mil
KEBA 100/185/5M	7-1/4" - 185 mm	16' 5" - 5 m	4 mil
KEBA 100/250/5M	10" - 250 mm	16' 5" - 5 m	4 mil
KEBA 100/125	5" - 125 mm	98' 5" - 30 m	4 mil
KEBA 100/185	7-1/4" - 185 mm	98' 5" - 30 m	4 mil
KEBA 100/250	10" - 250 mm	98' 5" - 30 m	4 mil

Note: 1 mil = 1 one-thousandth of an inch

Schluter®-KERDI-FLEX



KERDI-FLEX is a flexible polyethylene waterproofing strip used to seal movement joints over DITRA in specialty applications where large movements are expected, i.e. over expansion joints or construction joints.

Schluter®-KERDI-FLEX

Waterproofing strip for use above movement joints

Item No.	Width	Length	Thickness
FLEX 125/5M	5" - 125 mm	16' 5" - 5 m	12 mil
FLEX 250/5M	10" - 250 mm	16' 5" - 5 m	12 mil
FLEX 125/30	5" - 125 mm	98' 5" - 30 m	12 mil
FLEX 250/30	10" - 250 mm	98' 5" - 30 m	12 mil

Note: 1 mil = 1 one-thousandth of an inch

Schluter®-KERDI-KERECK-F

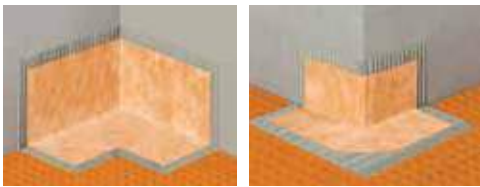

Inside Corner

Outside Corner

KERDI-KERECK-F are preformed, seamless corners made of KERDI for waterproofing inside and outside corners.

Schluter®-KERDI-KERECK-F

Waterproofing for corners

Item No.	Thickness	Packaging
KERECK/FI 2	4 mil	2 Inside corners
KERECK/FI 10	4 mil	10 Inside corners
KERECK/FA 2	4 mil	2 Outside corners
KERECK/FA 10	4 mil	10 Outside corners

Waterproofing for 135° corners

KERECK135/FI2	4 mil	2 Inside corners
KERECK135/FI10	4 mil	10 Inside corners

Note: 1 mil = 1 one-thousandth of an inch

Schluter®-KERDI-KM



KERDI-KM prefabricated seal is cut sections of the KERDI waterproofing membrane designed to seal protrusions through the KERDI or DITRA/DITRA-XL membranes. KERDI-KM is designed to be used in conjunction with Schluter®-KERDI-FIX or equivalent sealant to seal around pipes or other similar elements.

Schluter®-KERDI-KM

Pipe seal

Item No.	Dimensions	Thickness	Packaging
KM 5117/22	7" x 7" - 175 x 175 mm Hole diameter, $\phi = 7/8"$ - 22 mm	4 mil	5 units

Note: 1 mil = 1 one-thousandth of an inch

Schluter®-TROWEL



The **Schluter®-DITRA-TROWEL** features a 11/64" x 11/64" (4.5 mm x 4.5 mm) square-notched design, and is used to install the DITRA membrane.

The **Schluter®-DITRA-HEAT/-DITRA-XL-TROWEL** features a 1/4" x 1/4" (6 mm x 6 mm) square-notched design, and is used to install the DITRA-HEAT and DITRA-XL membranes.

The **Schluter®-KERDI-TROWEL** features a 1/8" x 1/8" (3 mm x 3 mm) square-notched design, and is used to install the KERDI membrane.

Schluter®-TROWEL		
Trowels used to install DITRA, DITRA-XL, DITRA-HEAT, and KERDI membranes		
Item No.	Notch Size	Packaging
Schluter®-DITRA-TROWEL		
TRL-DIT	11/64" x 11/64" (4.5 mm x 4.5 mm)	1 unit
TRL-DIT6	11/64" x 11/64" (4.5 mm x 4.5 mm)	6 units
Schluter®-KERDI-TROWEL		
TRL-KER	1/8" x 1/8" (3 mm x 3 mm)	1 unit
TRL-KER6	1/8" x 1/8" (3 mm x 3 mm)	6 units
Schluter®-DITRA-HEAT/-DITRA-XL-TROWEL		
TRL-DHXL	1/4" x 1/4" (6 mm x 6 mm)	1 unit
TRL-DHXL6	1/4" x 1/4" (6 mm x 6 mm)	6 units

Schluter®-DITRA-ROLLER



Used to embed DITRA membranes in the bond coat during membrane installation. The lightweight **DITRA-ROLLER** features a 14-1/2" (37 cm) wide roller and a shelf for placing 50 to 75 lbs of weight (e.g., bag of thin-set mortar or grout, box of tiles, etc.). Between uses, it can be conveniently disassembled for transport and storage.

Schluter®-DITRA-ROLLER	
Used to embed DITRA in the bond coat	
Item No.	Width
DIRO	14-1/2" (37 cm)

Schluter®-KERDI-FIX



KERDI-FIX is a single-component sealing and bonding compound with a silane-modified polymer base. It is odor-neutral, UV- and weather-resistant, and contains no solvents. KERDI-FIX is elastomeric and bonds well to most materials, such as wood, stone, concrete, metal, glass, and many plastics. KERDI-FIX is suitable for the bonding of KERDI waterproofing membrane to Schluter®-BARA balcony profiles and to vertical sections of floor/wall transitions that will not accept a bond to unmodified thin-set mortar. KERDI-FIX is also suitable for use as a sealant or as a joint filling compound.

Schluter®-KERDI-FIX	
Sealing and bonding compound	
Item No.	Description
KERDIFIX / color*	Cartridge (290 ml)

*Color Codes





Schluter SET™

Schluter SET™ is a premium unmodified thin-set mortar specifically formulated for use with Schluter® membranes and boards. It is sag-resistant, smooth and creamy, and easy to handle and spread. Schluter SET™ is suitable for use with ceramic, porcelain, and stone tile, including large and heavy tile, in conjunction with Schluter®-Systems' uncoupling and waterproofing membranes (e.g., DITRA, DITRA-HEAT, and KERDI), the Schluter®-Shower System, and Schluter®-KERDI-BOARD.

Schluter SET™ meets the requirements of ANSI A118.1T, and is available in both grey and white.

Premium unmodified mortar		
Item No.	Color	Weight
SET50G	Grey	50 lbs - 22.7 kg
SET50W	White	50 lbs - 22.7 kg



Schluter ALL-SET™

Schluter ALL-SET™ is a specialized modified thin-set mortar specifically formulated for use with Schluter® membranes and boards. It is engineered for use both under and over all DITRA and KERDI products. It is sag-resistant, smooth and creamy, and easy to handle and spread. Schluter ALL-SET™ is suitable for use with ceramic, porcelain, and stone tile, including large and heavy tile, in conjunction with Schluter®-Systems' uncoupling and waterproofing membranes (e.g., DITRA, DITRA-HEAT, and KERDI), the Schluter®-Shower System, and Schluter®-KERDI-BOARD.

Schluter ALL-SET™ meets the requirements of ANSI A118.4T, A118.11, and A118.15T, and is available in both grey and white.

Specialized modified mortar		
Item No.	Color	Weight
SETA50G	Grey	50 lbs - 22.7 kg
SETA50W	White	50 lbs - 22.7 kg



Schluter FAST-SET™

Schluter FAST-SET™ is a specialized rapid-setting modified thin-set mortar specifically formulated for use with Schluter® membranes and boards. It is engineered for use both under and over all DITRA and KERDI products. Schluter FAST-SET™ is ready to grout in 4 hours for fast-track projects. It is sag-resistant, smooth and creamy, and easy to handle and spread. Schluter FAST-SET™ is suitable for use with ceramic, porcelain, and stone tile, including large and heavy tile, in conjunction with Schluter®-Systems' uncoupling and waterproofing membranes (e.g., DITRA, DITRA-HEAT, and KERDI), the Schluter®-Shower System, and Schluter®-KERDI-BOARD.

Schluter FAST-SET™ meets the requirements of ANSI A118.4TF, A118.11, and A118.15TF, and is available in both grey and white.

Specialized rapid-setting mortar		
Item No.	Color	Weight
SETF50G	Grey	50 lbs - 22.7 kg
SETF50W	White	50 lbs - 22.7 kg

WARRANTIES

Schluter®-DITRA & Schluter®-DITRA-XL 10-Year Limited Warranty

COVERAGE AND CONDITIONS: Subject to the conditions and limitations as stated hereinafter, **Schluter®-Systems*** warrants that **Schluter®-DITRA** or **Schluter®-DITRA-XL** (the “Products”) will meet all composition and performance criteria for a period of ten (10) years from the date of purchase only when the Products are used and installed in accordance with the terms and conditions of the Schluter®-DITRA Installation Handbook and industry standard guidelines that are not in conflict with the Handbook in effect at the time of installation. Further, efflorescence is considered to be a natural occurrence with cementitious materials and is therefore not considered to be a defective condition and is not covered by this warranty. It is the responsibility of the owner/ builder/ installer to ensure the suitability of all building materials and all associated building materials for the owner’s intended use. It is recommended that the owner consult with an experienced and professional installer.

RESOLUTION: If the Products fail to meet this warranty, then the owner’s exclusive remedy and the sole obligation of Schluter®-Systems, at its election, shall be to a) reinstall or replace the failed portion of the floor covering assembly or b) pay an amount not to exceed the original square foot cost of the installation of the floor covering assembly verified to be defective. Floor covering assembly is defined to include all DITRA or DITRA-XL materials, non-reusable flooring surfaces, and the appropriate setting and grouting materials. Further, due to conditions beyond the control of Schluter- Systems (e.g., color and shade availability, discontinuation, normal wear and tear), Schluter®-Systems cannot guarantee or warrant an exact match to the specific tile, stone, or other flooring materials used in the installation. In such events, substantially similar materials may be substituted.

DISCLAIMER: THERE ARE NO WARRANTIES BEYOND THIS EXPRESSED WARRANTY AS STATED ABOVE. ALL OTHER WARRANTIES, REPRESENTATIONS OR CONDITIONS, EXPRESSED OR IMPLIED, ARE DISCLAIMED AND EXCLUDED, INCLUDING WARRANTIES, REPRESENTATIONS OR CONDITIONS OF **MERCHANTABILITY** OR FITNESS FOR A PARTICULAR PURPOSE ARISING BY STATUTE OR OTHERWISE BY LAW OR FROM A COURSE OF DEALING OR USAGE OF TRADE. SCHLUTER®-SYSTEMS EXCLUDES AND IN NO EVENT SHALL HAVE ANY LIABILITY FOR LOST PROFITS OR ANY OTHER INDIRECT, SPECIAL, INCIDENTAL, PUNITIVE, EXEMPLARY, OR CONSEQUENTIAL DAMAGES, ARISING OUT OF OR OTHERWISE CONNECTED TO FAILURE OF THE PRODUCTS OR FLOORING SYSTEM OF WHICH THEY ARE PART, NOR MISUSE OF THE PRODUCTS OR FLOORING SYSTEM, REGARDLESS OF ANY STRICT LIABILITY, ACTIVE OR PASSIVE NEGLIGENCE OF SCHLUTER®-SYSTEMS, AND REGARDLESS OF THE LEGAL THEORY (CONTRACT OR TORT OR EXTRA-CONTRACTUAL OR OTHER), NOR FROM ACTS OF WAR, TERRORISM, FAULTY AND NEGLIGENCE PENETRATION OF THE SYSTEM, FIRES, EXPLOSIONS, ACTS OF GOD, INTENTIONAL ACTS OF DESTRUCTION OR ANY LOSSES DUE TO STRUCTURAL FAILURE OR OTHER CAUSES UNRELATED TO THE PRODUCTS OR DELAYS, OR ANY OTHER INCIDENTAL OR CONSEQUENTIAL DAMAGES. THIS WARRANTY IS GIVEN IN LIEU OF ANY OTHER WARRANTY EXPRESSED OR IMPLIED. THE REMEDIES CONTAINED HEREIN ARE THE ONLY REMEDIES AVAILABLE FOR BREACH OF THIS WARRANTY. THIS LIMITED WARRANTY GIVES YOU SPECIFIC LEGAL RIGHTS; SOME STATES AND PROVINCES DO NOT ALLOW DISCLAIMERS OR OTHER RESTRICTIONS OF IMPLIED WARRANTIES, SO SOME OF THE ABOVE DISCLAIMERS MAY NOT APPLY TO YOU.

TRANSFERABILITY: This Limited Warranty extends ONLY to the original end user (defined as original intended owner and user of the property/unit in which the installation is incorporated - herein referred to as “Owner”) and is not transferable or assignable, unless approved in writing by the Schluter Systems Technical Services Director or an Officer of Schluter®-Systems or otherwise prohibited by specific state or provincial law.

MODIFICATIONS TO WARRANTY: No changes or modification of any terms or conditions of this warranty are allowed unless authorized by written agreement and signed by the Schluter Systems Technical Services Director or an Officer of Schluter®-Systems.

EFFECTIVE DATE: This warranty shall supersede and replace any and all prior oral or written warranties, agreements, or other such representations made by or on behalf of Schluter®-Systems relative to the Products or the application of the Products and shall apply to any installation occurring on or after October 1, 2017.

CLAIMS ON THIS LIMITED WARRANTY: To make a claim under this Limited Warranty, the Owner must provide Schluter®-Systems with written notice within 30 days of any alleged defect in the Products covered by this Limited Warranty, together with date and proof of purchase of the Products, proof of the costs of the original installation and name and address of all installers, failing which this Limited Warranty shall be of no legal effect. Schluter®-Systems reserves the right at its election and as a condition of this Limited Warranty to inspect the alleged failed and defective condition.

All U.S. Claims shall be sent to:

All Canadian Claims shall be sent to:

Schluter Systems L.P.
Attn: Warranty Claims Dept.
194 Pleasant Ridge Road
Plattsburgh, NY 12901-5841

Schluter Systems (Canada), Inc.
Attn: Warranty Claims Dept.
21100 chemin Ste-Marie
Ste-Anne-de-Bellevue, QC H9X 3Y8

*For the purpose of this warranty **Schluter Systems, L.P.** shall provide the warranty for all products for end users located in the United States, and **Schluter Systems (Canada) Inc.** shall provide the warranty for all products for end users located in Canada. This warranty is limited to sales of the Products made in and intended for use in the United States and Canada.

Schluter®-Systems Lifetime Thin-Set System Extended Limited Warranty

LIMITED WARRANTY COVERAGE: Subject to the conditions and limitations as stated in this **Lifetime Thin-Set System Extended Limited Warranty** (the "**Limited Warranty**"), Schluter Systems warrants that a Thin-Set System (defined hereafter) will be free from manufacturing defects and will perform as described in the applicable installation handbook(s) and/or technical data sheet(s) (collectively, the "**Written Materials**") for the lifetime (defined hereafter) of such Thin-Set System when installed in a Residential or Commercial application (defined hereafter) and used in accordance with the terms and conditions of the Written Materials and industry standard guidelines that are not in conflict with the Written Materials in effect at the time of installation. In order to extend warranty coverage for Schluter® DITRA® or DITRA®-XL uncoupling membranes, Schluter®-Shower System, Schluter® KERDI® or KERDI®-DS waterproofing membranes, or Schluter® DITRA-HEAT™ or Schluter® DITRA-HEAT-DUO™ uncoupling membrane to lifetime coverage under this Lifetime Thin-Set System Extended Limited Warranty, Owner must complete and submit the Thin-Set System Registration to Schluter Systems, available at www.schluter.com, or submit proof of purchase and installation information (including installation date, installer's name and address) to Schluter Systems at the address provided hereafter within ninety (90) days of installation.

For the purposes of this Limited Warranty, a "**Thin-Set System**" is defined as Schluter® DITRA® or DITRA®-XL uncoupling membranes, Schluter®-Shower System, Schluter®-KERDI®-BOARD within a Schluter®-Shower System, Schluter® KERDI® or KERDI®-DS waterproofing membranes, or Schluter® DITRA-HEAT™ or Schluter® DITRA-HEAT-DUO™ uncoupling membrane installed with Schluter SET™, Schluter ALL-SET™, or Schluter FAST-SET™ thin-set mortar; "**Owner**" is defined as the original end user of the property in which a Thin-Set System is installed; "**Lifetime**" is defined as that period of time that the original Thin-Set System installation remains unchanged and under the ownership of the Owner; "**Residential**" applications are defined to include Thin-Set System installations in single family detached residential dwellings; and "**Commercial**" applications are defined to include Thin-Set System installations in multi-family residential dwellings (e.g., apartments, condominiums, cooperatives, and timeshares). Thin-Set System installations in public places, commercial establishments and other applications may be afforded lifetime coverage under this Limited Warranty on a case by case basis as determined by the Schluter Systems Technical Services Director.

This Limited Warranty is only applicable to installations in the United States of America and Canada. Schluter Systems is not responsible or liable under any circumstances for determining the suitability of a Thin-Set System for the Owner's intended purpose. It is the responsibility of the Owner to consult with an experienced and professional installer to ensure the suitability of a Thin-Set System, subfloor/substrate and all building materials in the installation and that the Written Materials are followed properly.

RESOLUTION: If a Thin-Set System is installed and used in accordance with the terms and conditions as described hereinabove and such Thin-Set System is proven defective within the applicable warranty term, the Owner's exclusive remedy and the sole obligation of Schluter Systems, at its election, shall be to (a) reinstall or replace the failed portion of the Thin-Set System or (b) pay an amount not to exceed the original square foot cost of the installation of the Thin-Set System verified to be defective. Due to conditions beyond the control of Schluter Systems (e.g., color and shade availability, discontinuation, normal wear and tear), Schluter Systems cannot guarantee or warrant an exact match to the specific tile, stone, or other flooring materials used in the original installation. In such event, substantially similar materials may be substituted.

EXCLUSIONS FROM COVERAGE: This Limited Warranty excludes and in no event shall Schluter Systems have any liability for any indirect, special, incidental, punitive, exemplary, or consequential damages, including lost profits, arising out of or otherwise connected to the failure of a Thin-Set System, regardless of any strict liability or active or passive negligence of Schluter Systems, and regardless of legal theory, whether in contract, tort, extra-contractual or other. This Limited Warranty further excludes any loss or damage arising out of or otherwise connected to: acts of war, terrorism, fire, explosion, natural disaster, acts of God, any failure to comply with the Written Materials, inadequate subfloor/substrate, improper preparation or other failure of subfloor/substrate, faulty or negligent penetration of a Thin-Set System or subfloor/substrate, intentional acts of destruction, structural failure, misuse of or failure to maintain a Thin-Set System, normal wear and tear, scratches, dents, corrosion or discoloration (whether caused by excessive heat, chemical cleaning products, abrasive agents or otherwise), efflorescence and shading which are a natural occurrence with cementitious materials and are not considered a defective condition for the purposes of this Limited Warranty, variations of texture, color or shade from those on product samples, packaging materials or other marketing materials, or other causes unrelated to a Thin-Set System (e.g. excess point loading, overvoltage). This Limited Warranty excludes exterior, submerged and steam room applications and further excludes applications using glass tile, resin-backed tile, and/or moisture sensitive stone unless specifically approved in writing on a case by case basis by the Schluter Systems Technical Services Director. Schluter® DITRA-HEAT™-E-HK heating cables and Schluter® DITRA-HEAT™-E thermostats are specifically excluded from coverage under this Limited Warranty. Any substitution of a non-Schluter Systems product for a Schluter Systems component in a Thin-Set System voids this Limited Warranty.

DISCLAIMER: There are no warranties beyond this expressed warranty as stated herein. To the extent permitted by law, all other warranties, representations or conditions, expressed or implied, are hereby disclaimed and excluded, including but not limited to the implied warranties of **MERCHANTABILITY** or **FITNESS FOR A PARTICULAR PURPOSE** (as limited to such purposes as described in the Written Materials) or arising from a course of dealing, usage of trade or otherwise by law. ANY IMPLIED WARRANTIES ARISING BY OPERATION OF LAW ARE LIMITED IN DURATION TO THE TERM OF THIS LIMITED WARRANTY. NO REPRESENTATION, PROMISE, AFFIRMATION OR STATEMENT BY ANY EMPLOYEE OR AGENT OF SCHLUTER SYSTEMS WILL BE ENFORCEABLE AGAINST SCHLUTER SYSTEMS UNLESS IT IS SPECIFICALLY INCLUDED IN THIS LIMITED WARRANTY OR AUTHORIZED IN WRITING BY THE SCHLUTER SYSTEMS TECHNICAL SERVICES DIRECTOR. This Limited Warranty is given in lieu of any other warranty, whether expressed or implied. The remedies contained herein are the only remedies available for breach of this Limited Warranty. Schluter Systems excludes and in no event shall have any liability for any indirect, special, incidental, punitive, exemplary, or consequential damages, including lost profits, arising out of or otherwise connected to failure of a Thin-Set System. This Limited Warranty extends only to the Owner and is not transferable or assignable unless authorized by written agreement and signed by the Schluter Systems Technical Services Director or otherwise prohibited by specific state or provincial law. This Limited Warranty gives you specific legal rights; some states and provinces do not allow disclaimers or other restrictions of implied warranties; some of the above disclaimers may not apply to you. **No changes or modifications of any terms or conditions of this Limited Warranty are permitted unless duly authorized in writing by the Schluter Systems Technical Services Director.** This Limited Warranty shall supersede and replace any and all prior oral or written warranties, agreements, or other representations made by or on behalf of Schluter Systems relative to a Thin-Set System or the application of a Thin-Set System and shall apply to any installation occurring on or after March 13, 2017. For the most current information and materials regarding Schluter Systems warranties and programs, please visit https://www.schluter.com/schluter-us/en_US/downloadfiles.

MAKING A CLAIM: To make a claim under this Limited Warranty, the Owner must provide Schluter Systems with written notice within thirty (30) days of any alleged defect in a Thin-Set System covered by this Limited Warranty, together with date and proof of purchase of such Thin-Set System and/or all of its components and name and address of all installers and all invoices related to the original installation, failing which this Limited Warranty shall have no legal effect. Schluter Systems reserves the right at its election and as a condition of this Limited Warranty to inspect the alleged failed and/or defective Thin-Set System.

All U.S. Claims shall be sent to:

All Canadian Claims shall be sent to:

Schluter Systems L.P.
Attn: Warranty Claims Dept.
194 Pleasant Ridge Road
Plattsburgh, NY 12901-5841

Schluter Systems (Canada), Inc.
Attn: Warranty Claims Dept.
21100 chemin Ste-Marie
Ste-Anne-de-Bellevue, QC H9X 3Y8



552378 10/2017 © 2017 Schluter Systems L.P. DITRA is a registered trademark of Schluter Systems

Schluter Systems L.P. • 194 Pleasant Ridge Road, Plattsburgh, NY 12901-5841 • Tel.: 800-472-4588 • Fax: 800-477-9783
Schluter Systems (Canada) Inc. • 21100 chemin Ste-Marie, Ste-Anne-de-Bellevue, QC H9X 3Y8 • Tel.: 800-667-8746 • Fax: 877-667-2410

www.schluter.com