

HYDRO-BLOK[®]
The BETTER Shower System

www.hydroblok.com

HYDROBLOK Grand International Inc.
701 S Carson St, Suite 200
Carson City, NV 89701
Tel: 1-844-588-9559

SKU		HBSP3648	
Description			
36" x 48" SHOWER PAN			
Date	Revision	Scale	Drawing Number
July 1, 2020	2020.1	1:12	
Drawn by:	Approved by:	Usage	1 of 1
CC	PC	Distribution	

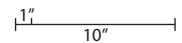
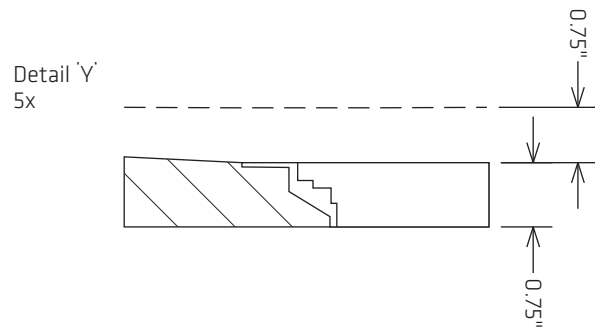
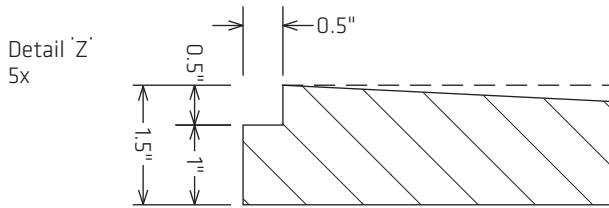
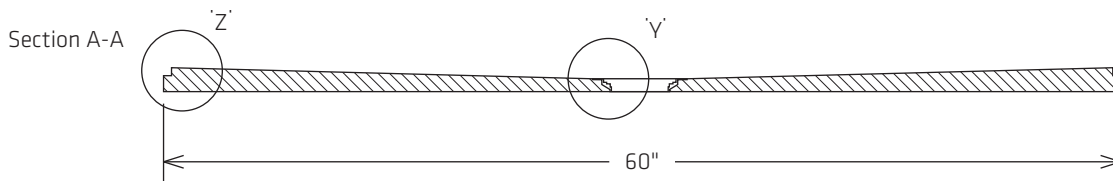
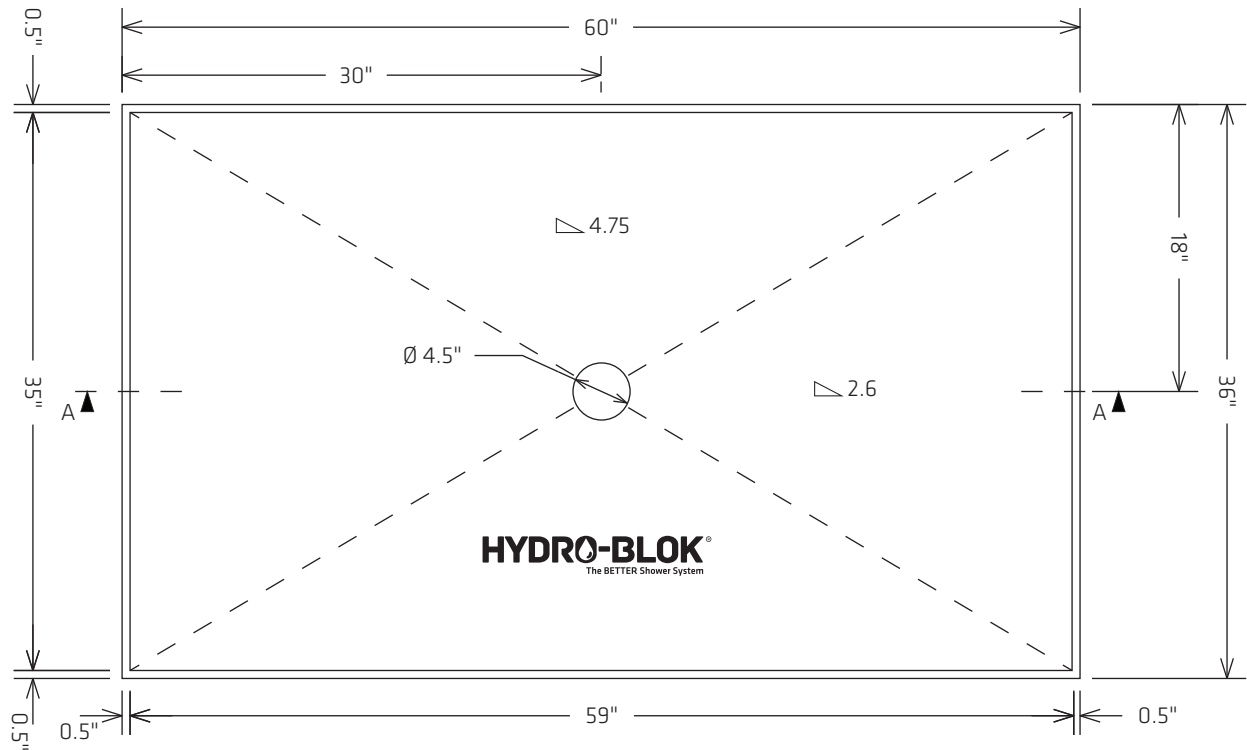

HYDRO-BLOK®

The BETTER Shower System

www.hydroblok.com

HYDROBLOK Grand International Inc.
701 S Carson St, Suite 200
Carson City, NV 89701
Tel: 1-844-588-9559

SKU

HBSP3660

Description

36" x 60" SHOWER PAN

Date July 1, 2020

Revision 2020.1

Scale 1:12

Drawing Number

Drawn by: CC

Approved by: PC

Usage Distribution

1 of 1

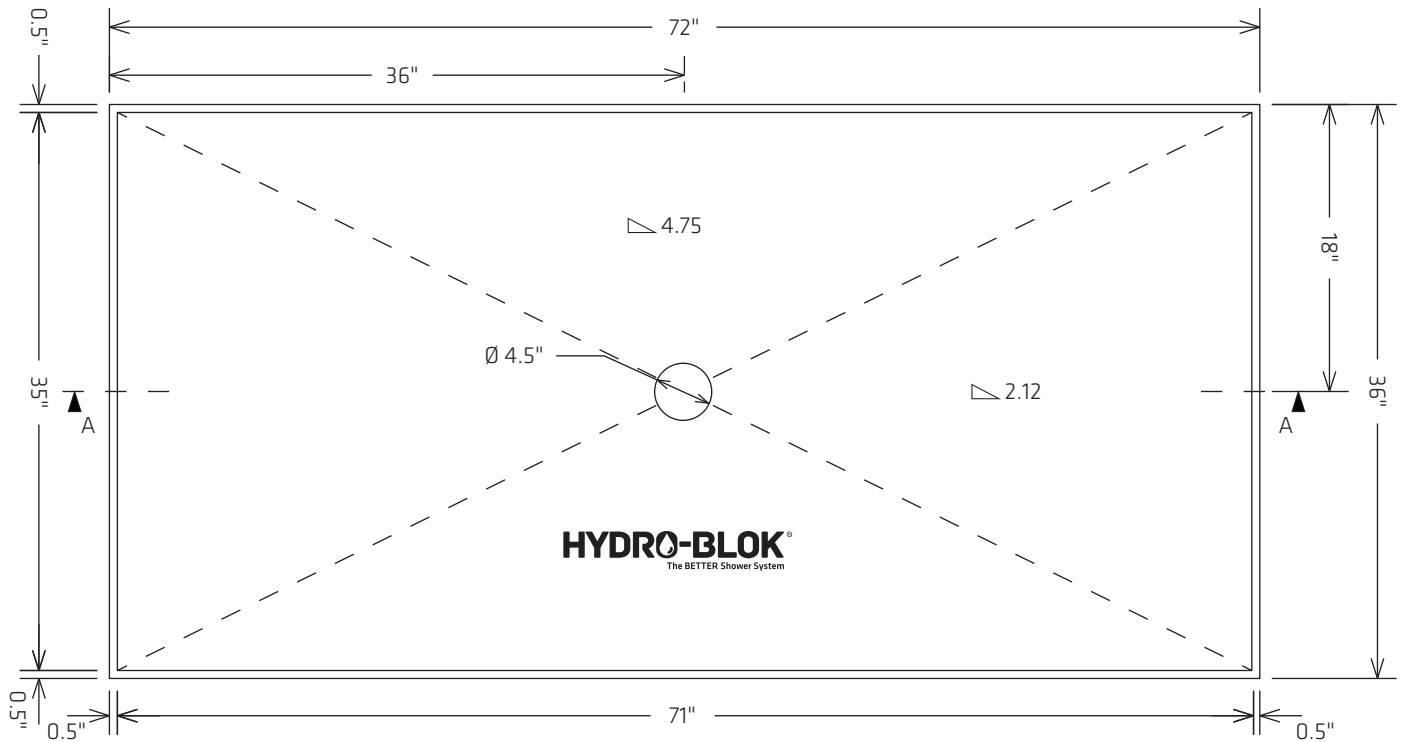

Section A-A

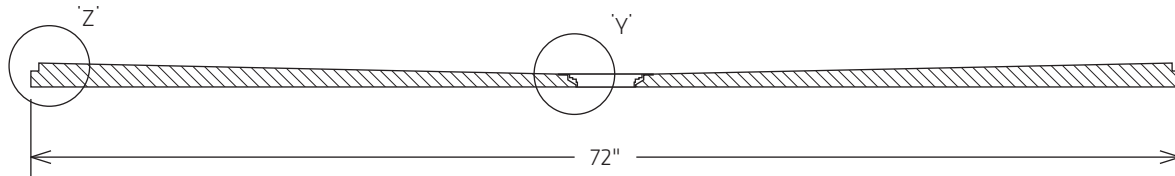

Detail Z-Z
5x

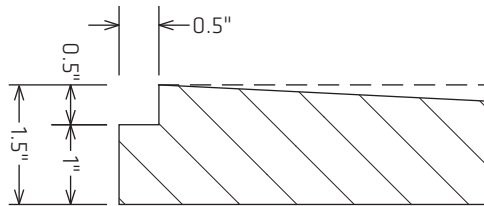

Detail Y-Y
5x

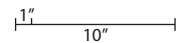
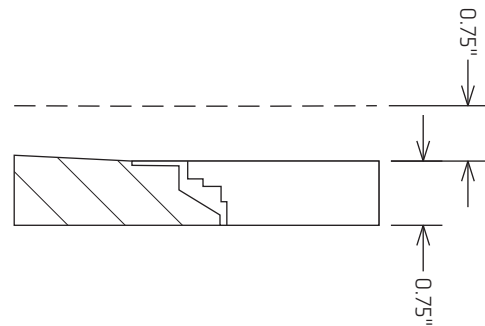

HYDRO-BLOK[®]

The BETTER Shower System

www.hydroblok.com

HYDROBLOK Grand International Inc.
701 S Carson St, Suite 200
Carson City, NV 89701
Tel: 1-844-588-9559

SKU

HBSP3672

Description

36" x 72" SHOWER PAN

Date

July 1, 2020

Revision

2020.1

Scale

1:12

Drawing Number

1 of 1

Drawn by:

CC

Approved by:

PC

Usage

Distribution

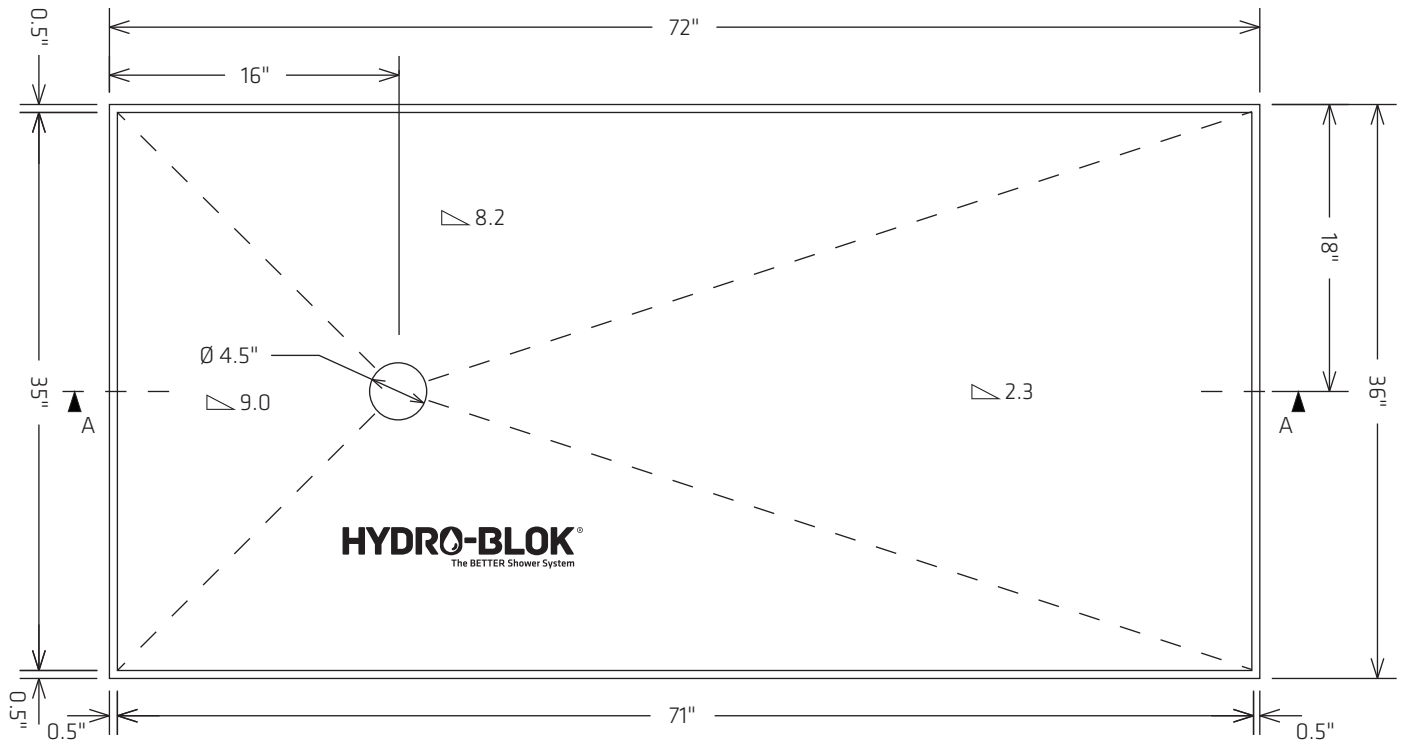

Section A-A

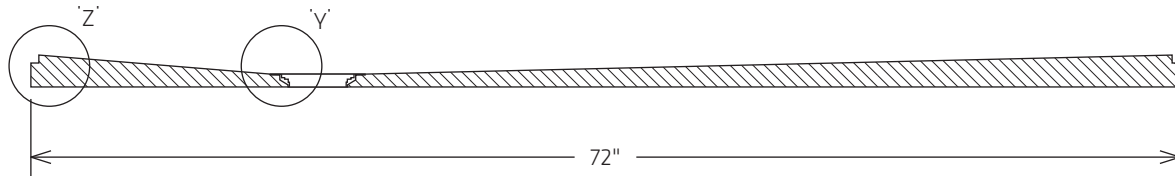

Detail Z'
5x

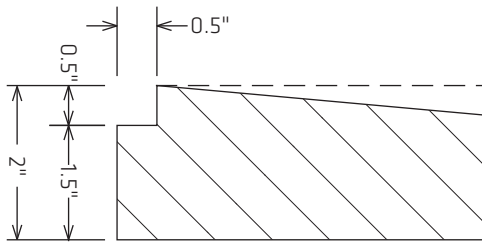

Detail Y'
5x

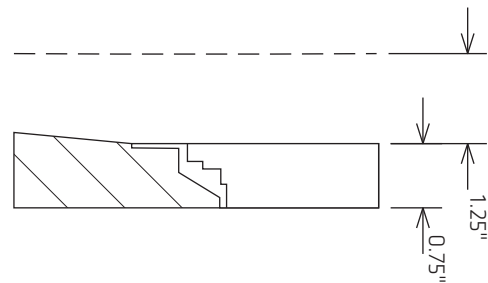

1" 10"

HYDRO-BLOK[®]
The BETTER Shower System

www.hydroblok.com

HYDROBLOK Grand International Inc.
701 S Carson St, Suite 200
Carson City, NV 89701
Tel: 1-844-588-9559

SKU

HBSP36720D

Description

36" x 72" SHOWER PAN - OFFSET DRAIN

Date July 1, 2020

Revision 2020.1

Scale 1:12

Drawing Number

Drawn by: CC

Approved by: PC

Usage Distribution

1 of 1

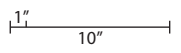
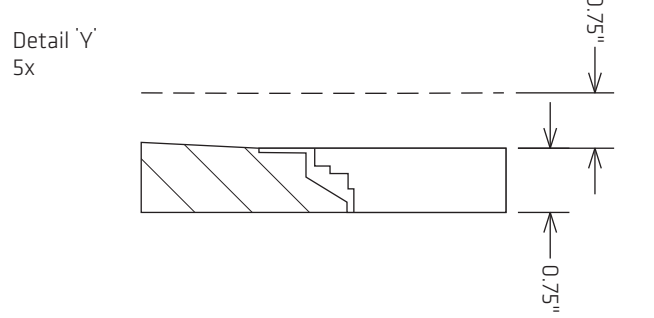
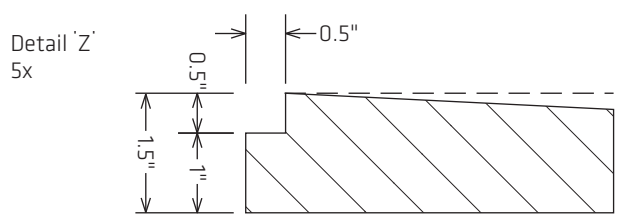
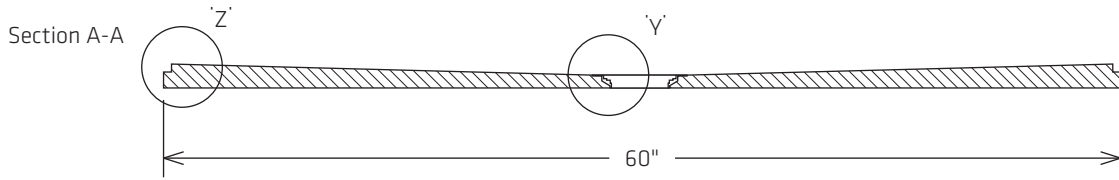
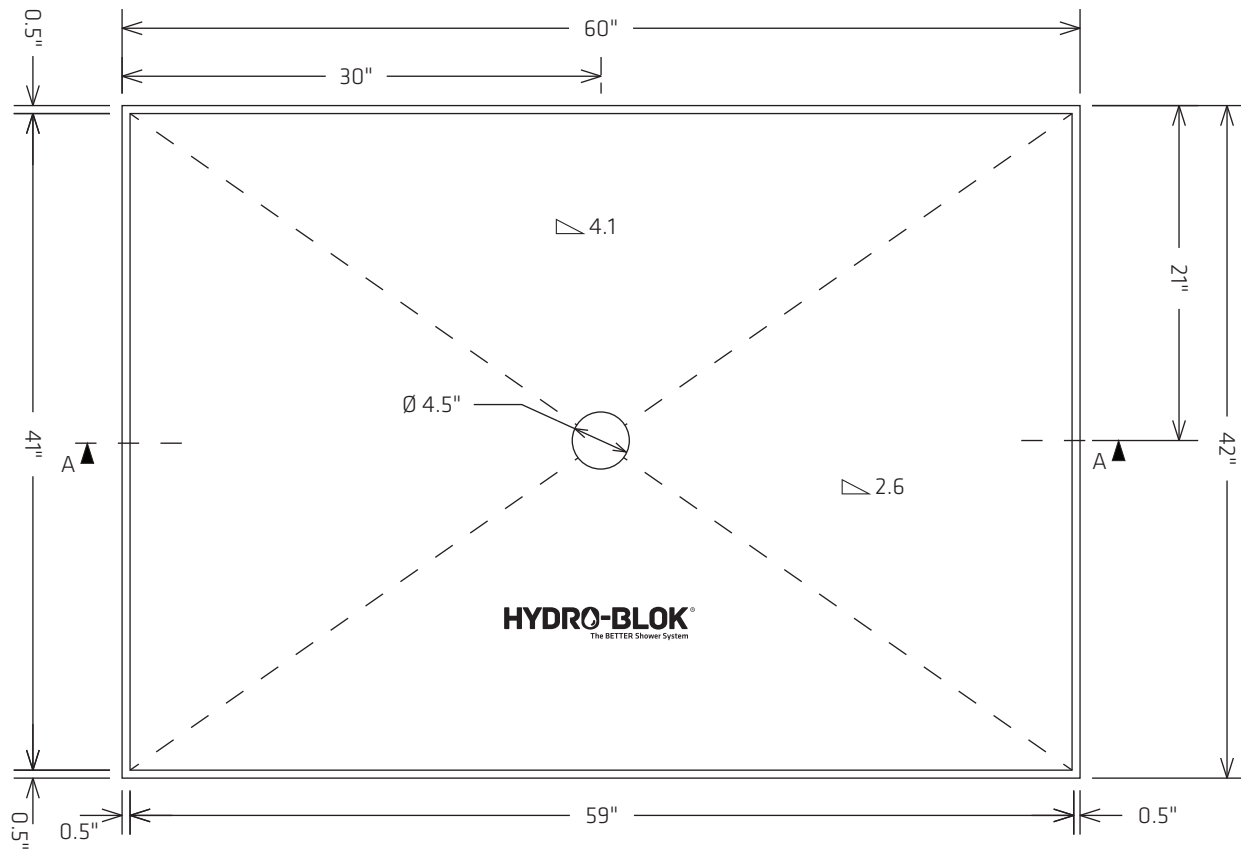

HYDRO-BLOK[®]
The BETTER Shower System

www.hydroblok.com

HYDROBLOK Grand International Inc.
701 S Carson St, Suite 200
Carson City, NV 89701
Tel: 1-844-588-9559

SKU		HBSP4260	
Description			
Date		Revision	
July 1, 2020	2020.1	Scale	1:12
Drawing Number		Usage	
1 of 1		Distribution	
Drawn by:	Approved by:		
CC	PC		

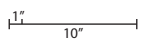
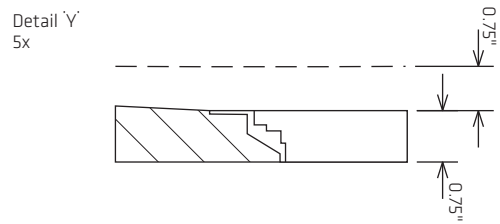
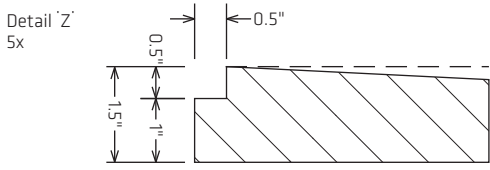
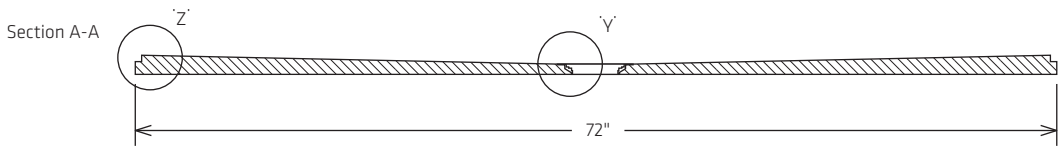
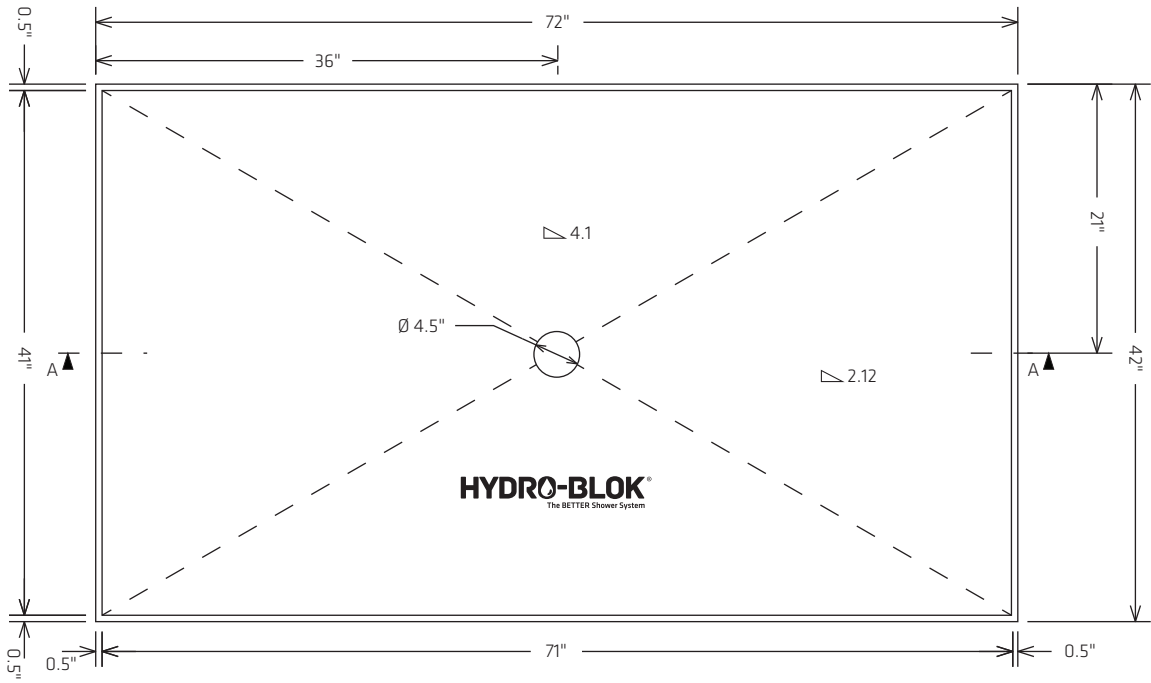

HYDRO-BLOK[®]
The BETTER Shower System

www.hydroblok.com

HYDROBLOK Grand International Inc.
701 S Carson St, Suite 200
Carson City, NV 89701
Tel: 1-844-588-9559

SKU		HBSP4272	
Description			
Date		Revision	
July 1, 2020		2020.1	
Drawn by:		Approved by:	
CC		PC	
Scale		Usage	
1:15		Distribution	
Drawing Number			1 of 1

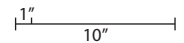
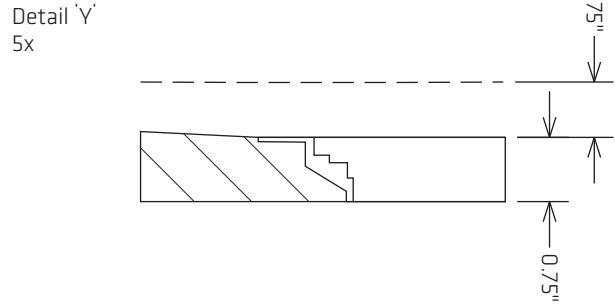
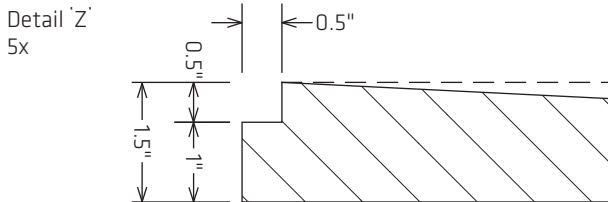
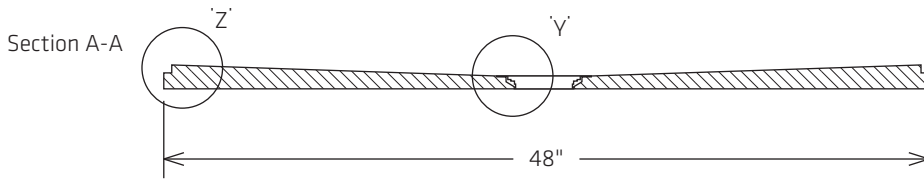
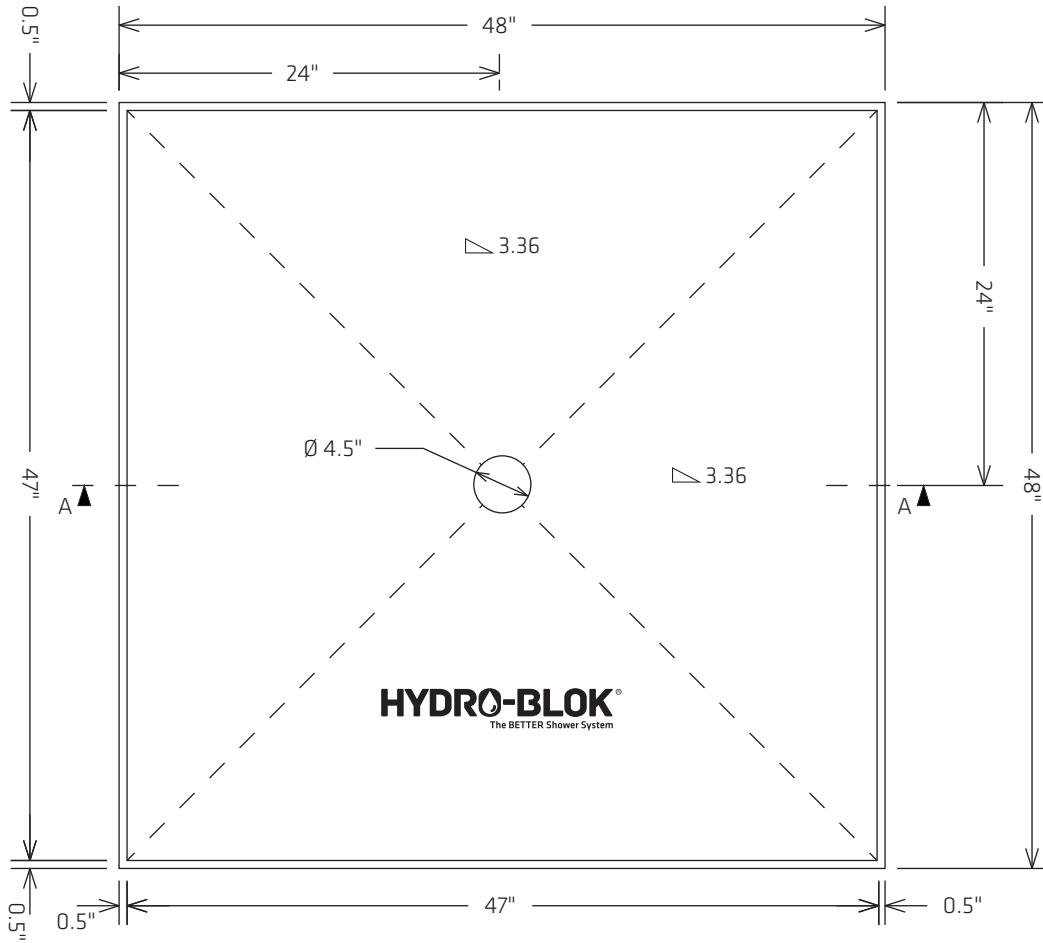

HYDRO-BLOK®
The BETTER Shower System

www.hydroblok.com

HYDROBLOK Grand International Inc.
701 S Carson St, Suite 200
Carson City, NV 89701
Tel: 1-844-588-9559

SKU

HBSP4848

Description

48" x 48" SHOWER PAN

Date July 1, 2020

Revision 2020.1

Scale 1:12

Drawing Number

Drawn by: CC

Approved by: PC

Usage Distribution

1 of 1

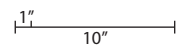
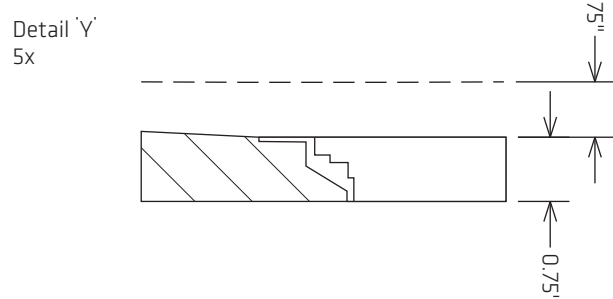
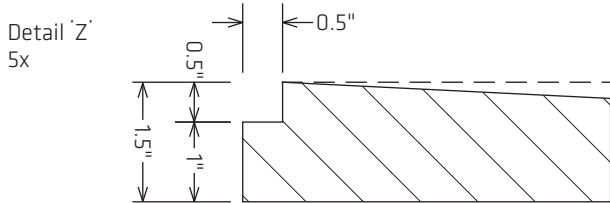
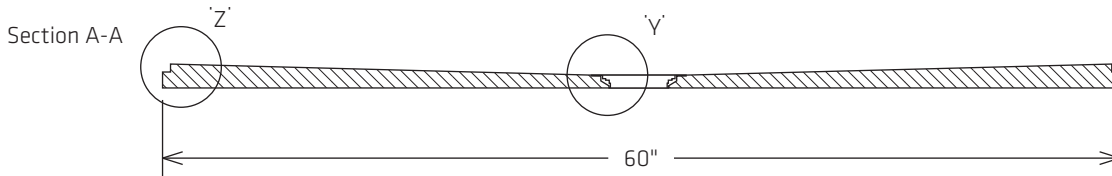
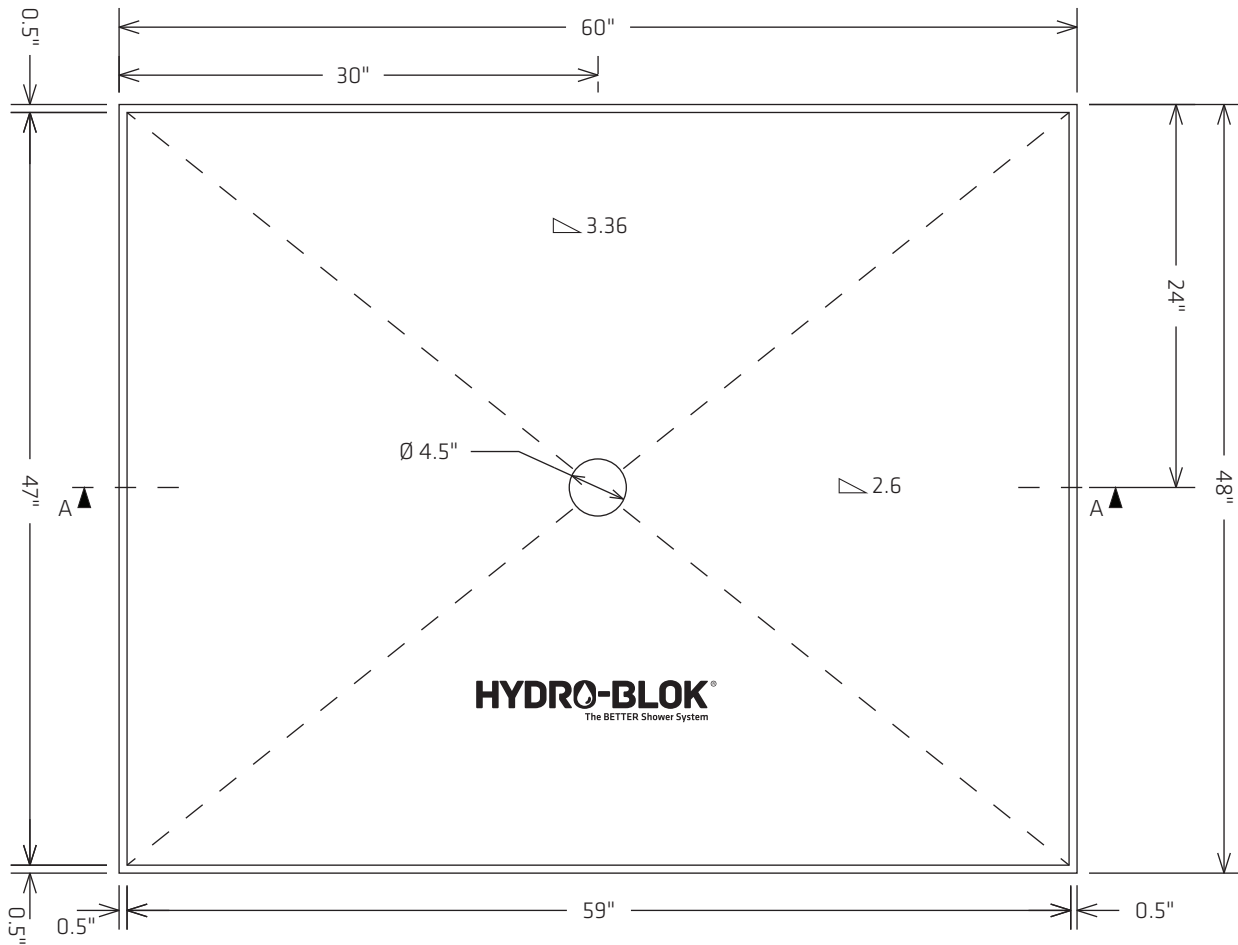

HYDRO-BLOK®

The BETTER Shower System

www.hydroblok.com

HYDROBLOK Grand International Inc.
701 S Carson St, Suite 200
Carson City, NV 89701
Tel: 1-844-588-9559

SKU

HBSP4860

Description

48" x 60" SHOWER PAN

Date

July 1, 2020

Revision

2020.1

Scale

1:12

Drawn by:

CC

Approved by:

PC

Usage

Distribution

Drawing Number

1 of 1

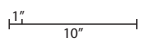
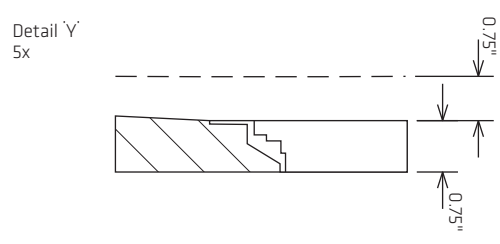
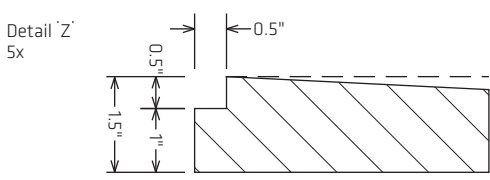
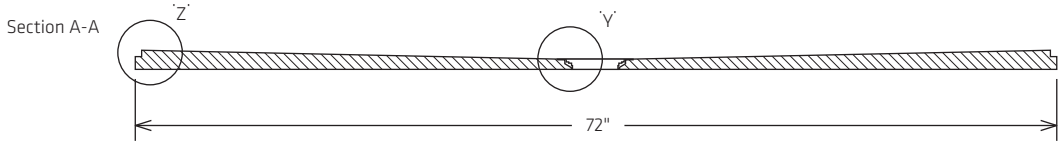
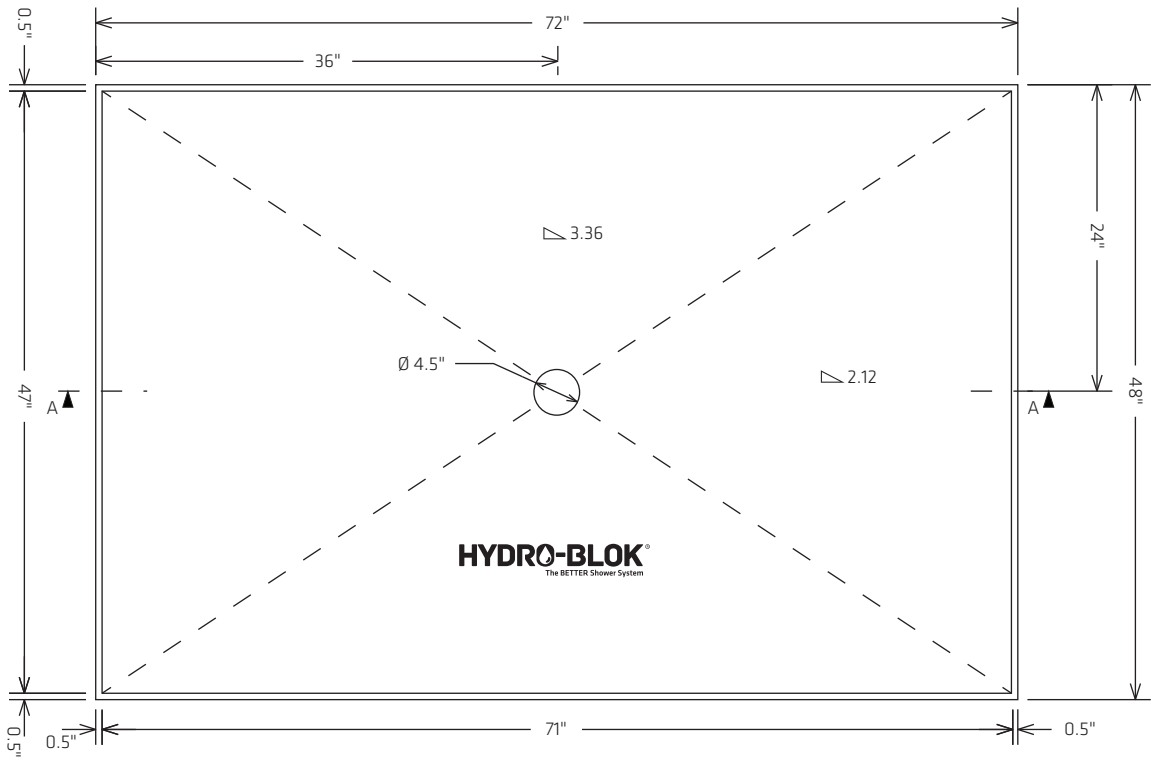

HYDRO-BLOK[®]
The BETTER Shower System

www.hydroblok.com

HYDROBLOK Grand International Inc.
701 S Carson St, Suite 200
Carson City, NV 89701
Tel: 1-844-588-9559

SKU		HBSP4872	
Description			
48" x 72" SHOWER PAN			
Date	Revision	Scale	Drawing Number
July 1, 2020	2020.1	1:15	
Drawn by:	Approved by:	Usage	1 of 1
CC	PC	Distribution	

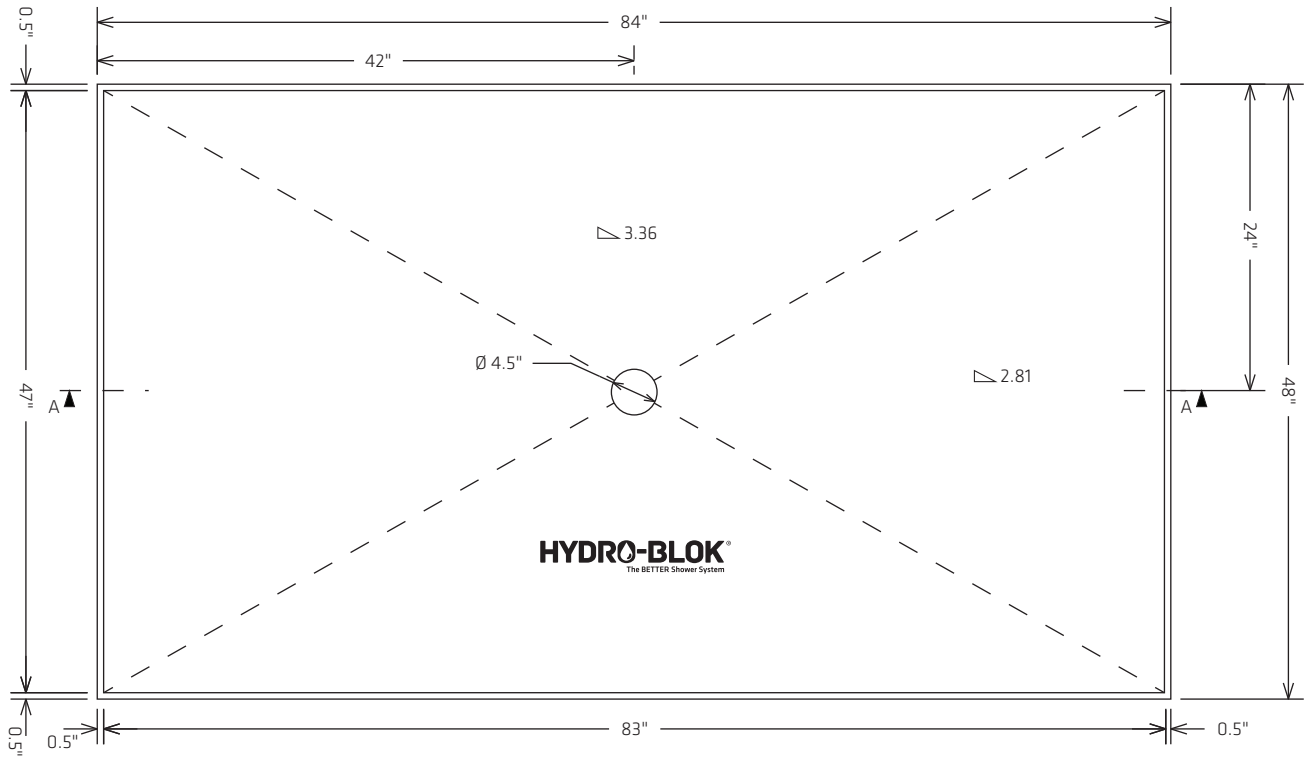

Section A-A

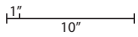
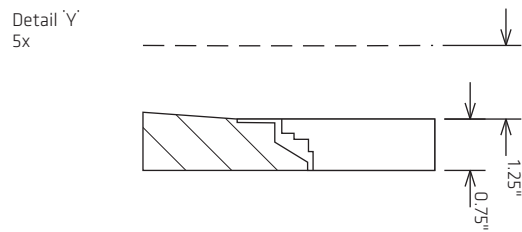
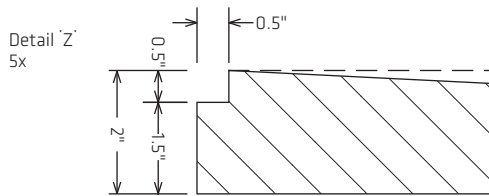
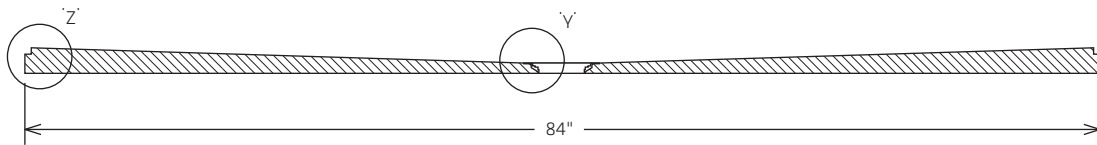

HYDRO-BLOK®

The BETTER Shower System

www.hydroblok.com

HYDROBLOK Grand International Inc.
701 S Carson St, Suite 200
Carson City, NV 89701
Tel: 1-844-588-9559

SKU

HPSP4884

Description

48" x 84" SHOWER PAN

Date July 1, 2020

Revision 2020.1

Scale 1:15

Drawing Number

Drawn by: CC

Approved by: PC

Usage Distribution

1 of 1

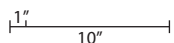
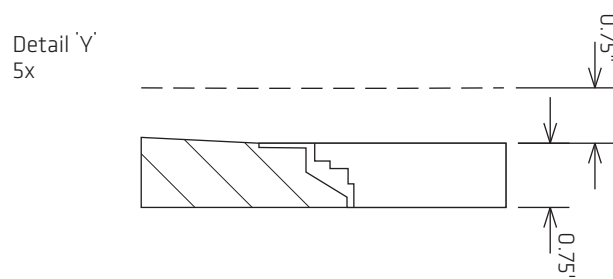
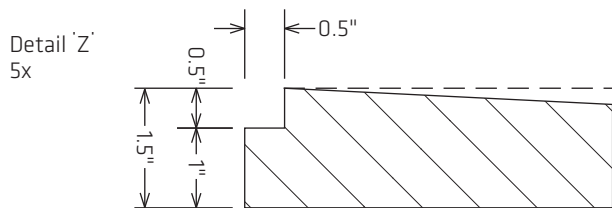
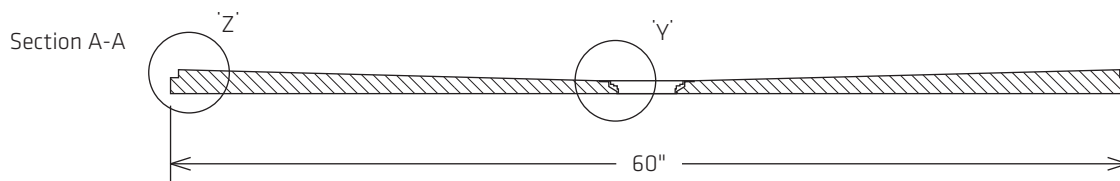
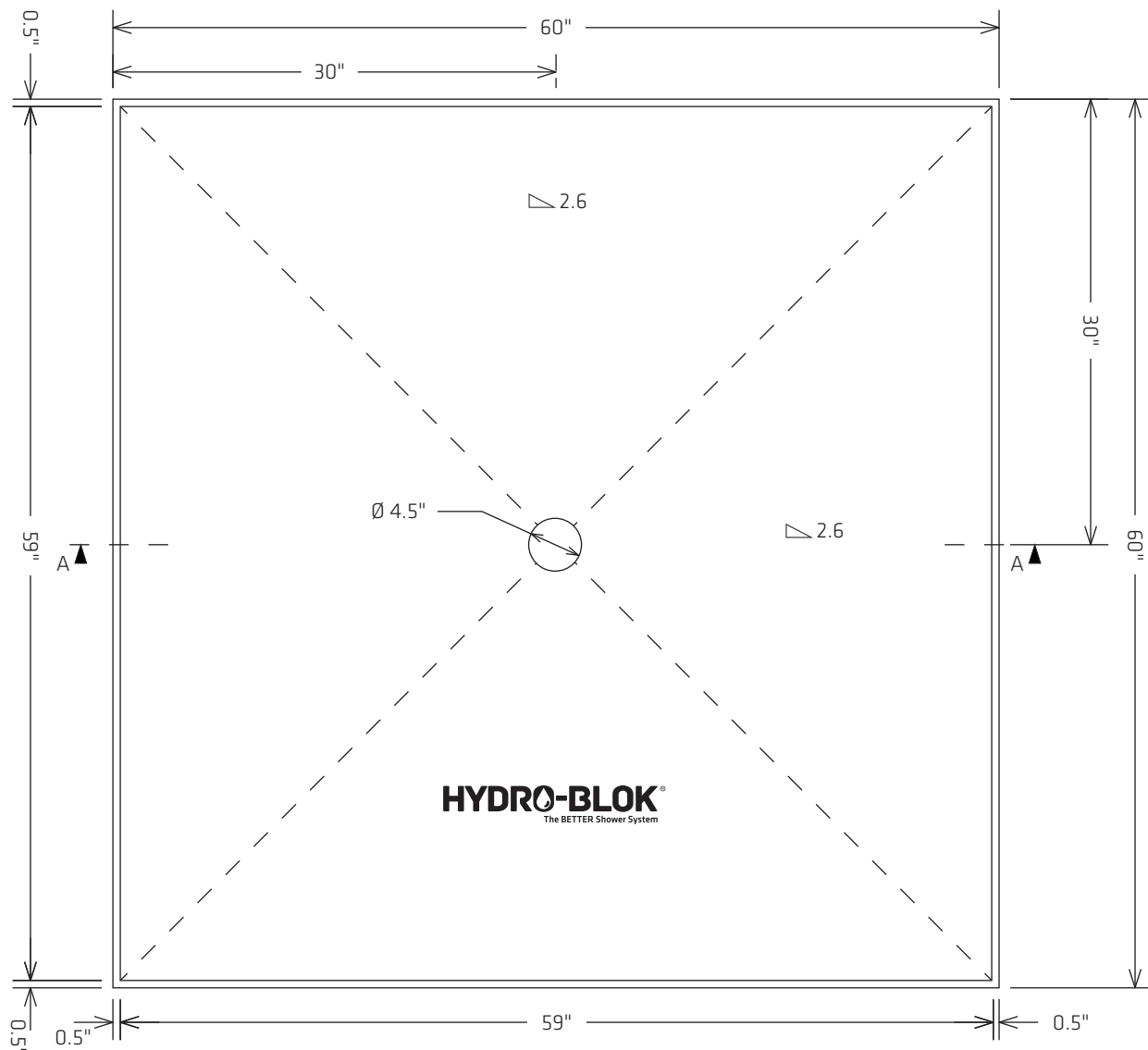

HYDRO-BLOK®

The BETTER Shower System

www.hydroblok.com

HYDROBLOK Grand International Inc.
701 S Carson St, Suite 200
Carson City, NV 89701
Tel: 1-844-588-9559

SKU

HBSP6060

Description

60" x 60" SHOWER PAN

Date July 1, 2020

Revision 2020.1

Scale 1:12

Drawing Number

Drawn by: CC

Approved by: PC

Usage Distribution

1 of 1

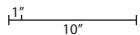
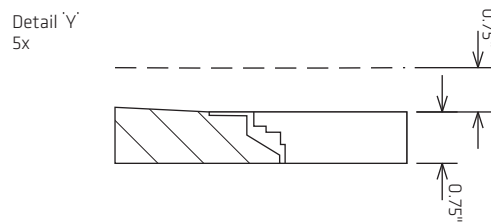
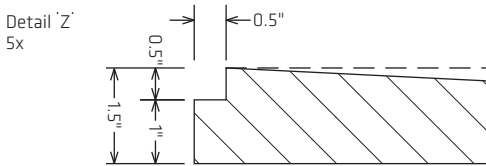
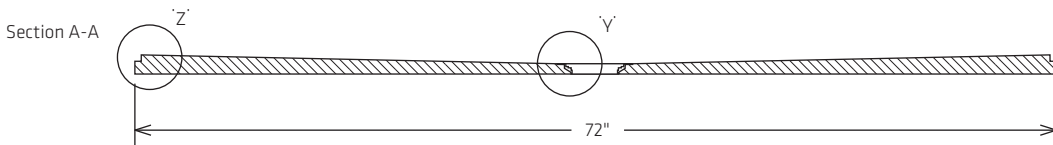
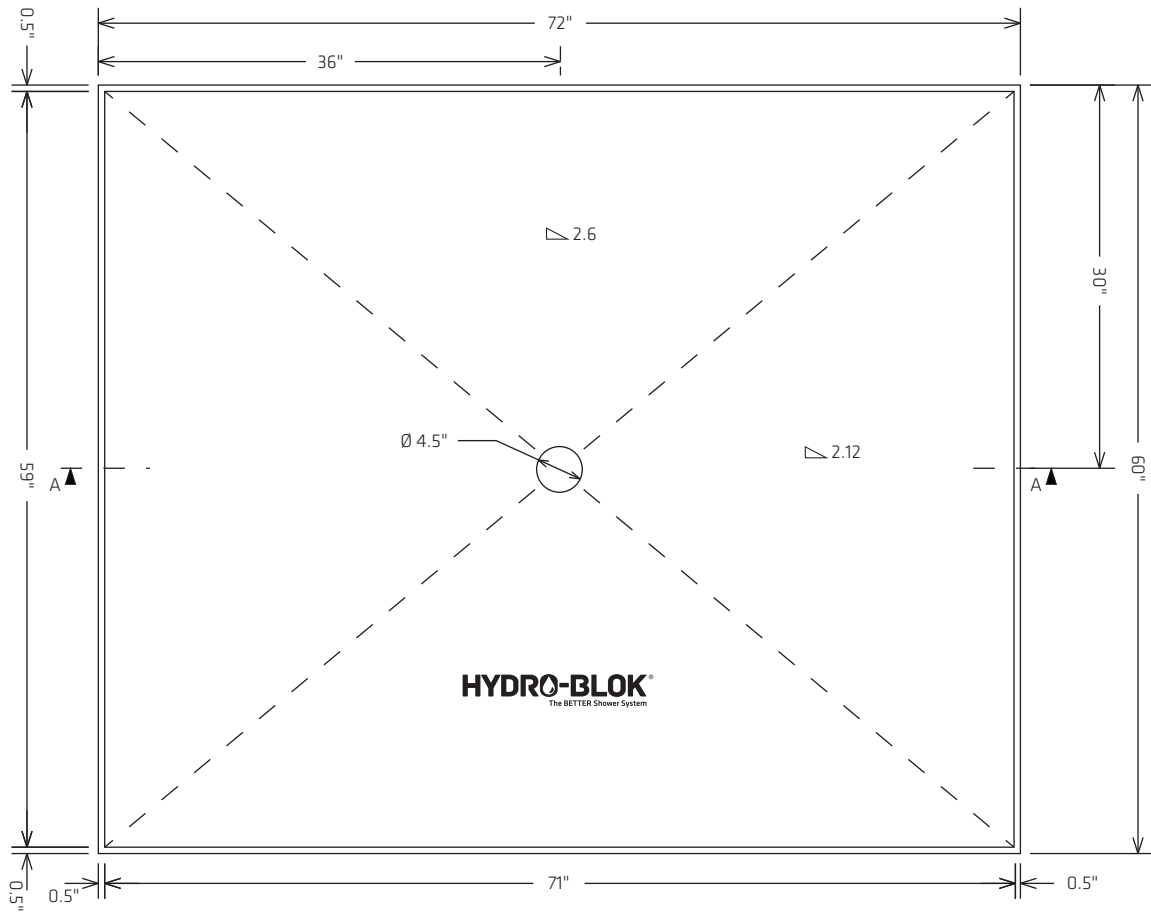

HYDRO-BLOK®

The BETTER Shower System

www.hydroblok.com

HYDROBLOK Grand International Inc.
701 S Carson St, Suite 200
Carson City, NV 89701
Tel: 1-844-588-9559

SKU

HBSP6072

Description

60" x 72" SHOWER PAN

Date July 1, 2020

Revision 2020.1

Scale 1:15

Drawing Number

Drawn by: CC

Approved by: PC

Usage Distribution

1 of 1

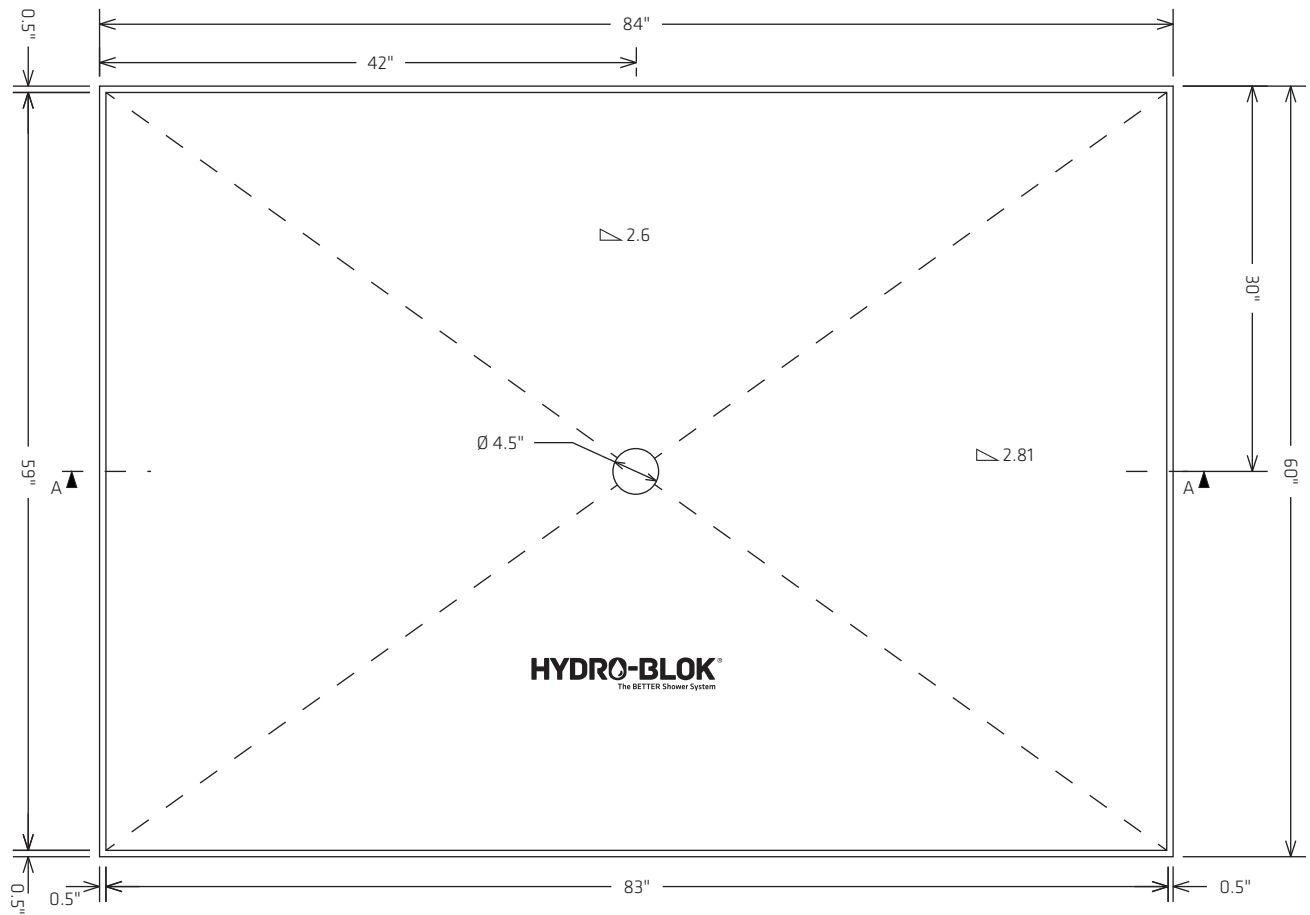

Section A-A

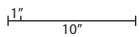
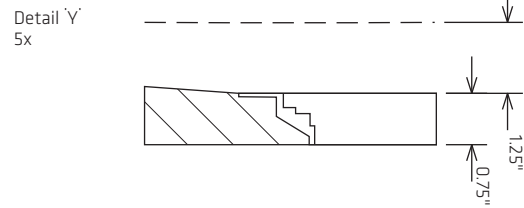
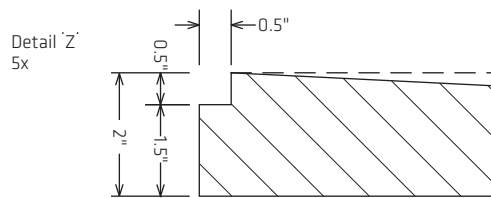
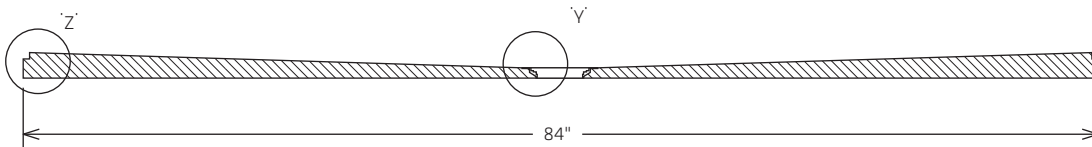

HYDRO-BLOK®

The BETTER Shower System

www.hydroblok.com

HYDROBLOK Grand International Inc.
701 S Carson St, Suite 200
Carson City, NV 89701
Tel: 1-844-588-9559

SKU

HBSP6084

Description

60" x 84" SHOWER PAN

Date July 1, 2020

Revision 2020.1

Scale 1:15

Drawing Number

Drawn by: CC

Approved by: PC

Usage Distribution

1 of 1

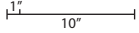
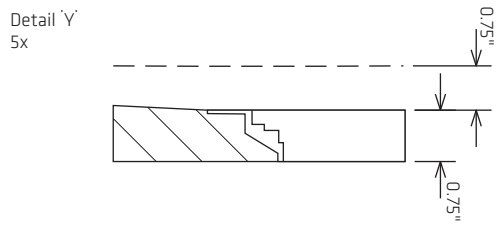
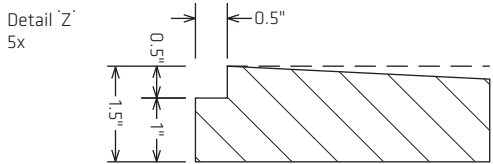
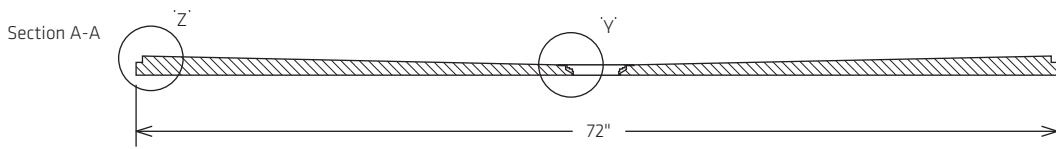
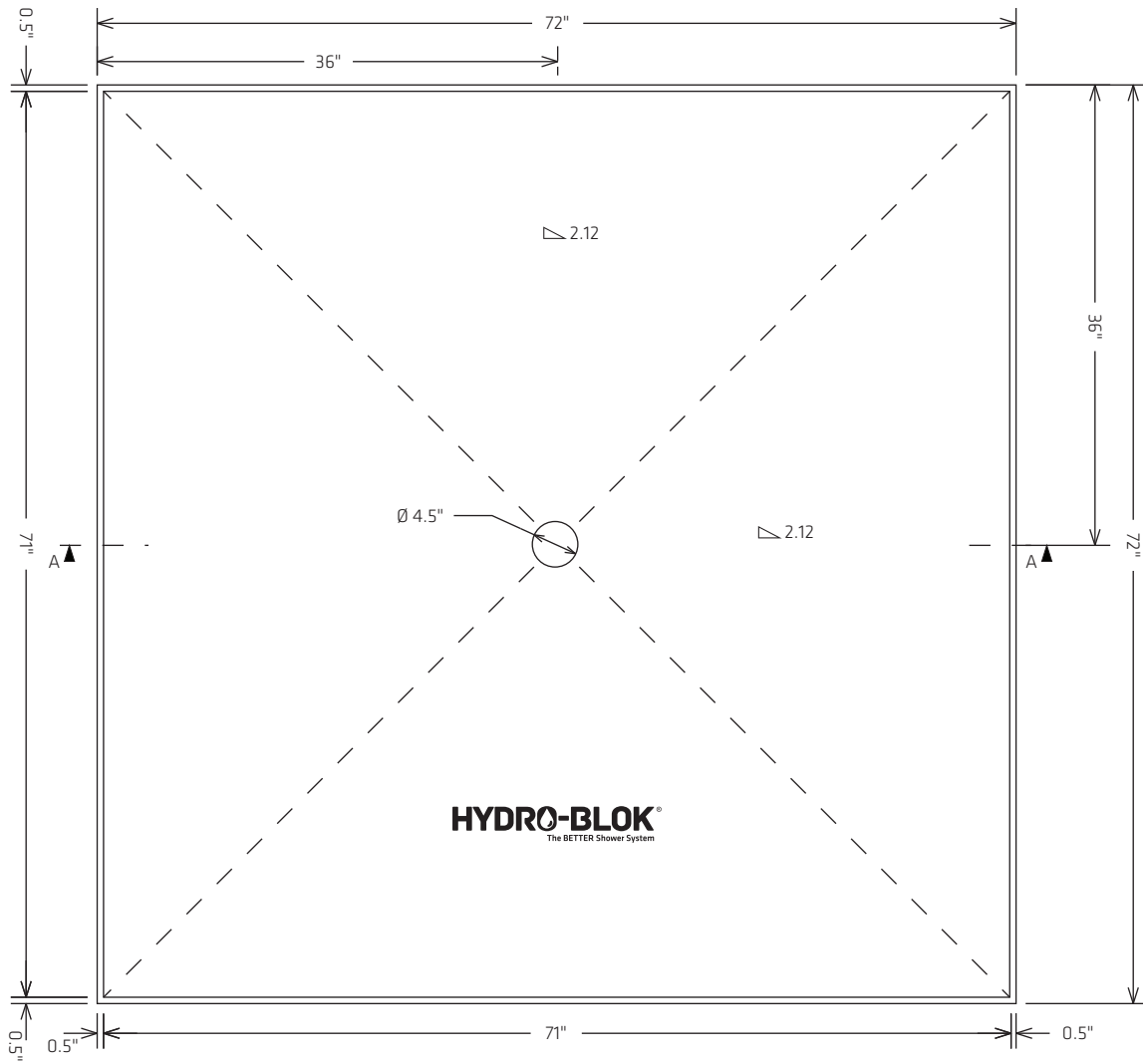

HYDRO-BLOK®

The BETTER Shower System

www.hydroblok.com

HYDROBLOK Grand International Inc.
701 S Carson St, Suite 200
Carson City, NV 89701
Tel: 1-844-588-9559

SKU
HBSP7272

Description
72" x 72" SHOWER PAN

Date July 1, 2020	Revision 2020.1	Scale 1:15	Drawing Number 1 of 1
Drawn by: CC	Approved by: PC	Usage Distribution	