

MK-101-24 OWNER'S MANUAL & OPERATING INSTRUCTIONS



MK-101-24
Part # 169612

Revision 104	11.2014
Manual Part No. 169689	

Caution: Read all safety and operating instructions before using this equipment. This owners manual **MUST** accompany the equipment at all times.

INTRODUCTION

Congratulations on your purchase of a MK-101-24 Tile Saw. We are certain that you will be pleased with your purchase. MK Diamond takes pride in producing the finest construction power tools and diamond blades in the industry.

Operated correctly, your MK-101-24 should provide you with years of service. In order to help you, we have included this manual. This owners manual contains information necessary to operate and maintain your Tile Saw safely and correctly. Please take a few minutes to familiarize yourself with the saw by reading and reviewing this manual.

If you should have questions concerning your saw, please feel free to call our friendly customer service department at: 800 421-5830

Regards,

MK Diamond

NOTE THIS INFORMATION FOR FUTURE USE:

MODEL NUMBER:	
SERIAL NUMBER:	
PURCHASE PLACE:	
PURCHASE DATE:	

NOTE: For your (1) one year warranty to be effective, complete the warranty card (including the Serial Number) and mail it in as soon as possible.

TABLE OF CONTENTS

SAFETY

Safety Messages	4
General Safety Precautions & Hazard Symbols	4-7
California Proposition 65 Message	8
Electrical Requirements	9
Electric Motor Safety	10-12
Safety Label Locations	14
Product Specifications	15

UNPACKING, TRANSPORT and ASSEMBLY

Unpacking	16
Contents	16
Transport	17
Stand (Optional)	17
Assembly	18-20

SETUP, STARTUP, ADJUSTMENT, OPERATION and SHUTDOWN

Setup	21-23
Operation	24-27
Cutting Head Adjustment	28-29
Cleanup	30

MAINTENANCE AND TROUBLESHOOTING

Maintenance	31-36
Troubleshooting	37-41

EXPLODED VIEW AND PARTS LIST

Exploded View & Parts List	42-49
----------------------------	-------

ACCESSORIES ORDERING and RETURN INSTRUCTIONS

Theory of Diamond Blade	50
Accessories	52
Ordering Information	54
Return Material Policy	54
Packaging Instructions	54

CONTACT and LIMITED WARRANTY

Contact and Warranty	55
----------------------	----

Read and follow all safety, operating and maintenance instructions. Failure to read and follow these instructions could result in injury or death to you or others. Failure to read and follow these instructions could also result in damage and/or reduced equipment life. Safety warnings and guidelines do not by themselves eliminate danger. They are not substitutes for proper accident prevention procedures and good judgement.

SAFETY MESSAGES

A safety message alerts you to potential hazards that could hurt you or others. Each safety message is preceded by a safety alert symbol () and one of three words: **DANGER**, **WARNING**, or **CAUTION**.



DANGER You **WILL** be **KILLED** or **SERIOUSLY INJURED** if you **DO NOT** follow directions.



WARNING You **CAN** be **KILLED** or **SERIOUSLY INJURED** if you **DO NOT** follow directions.



CAUTION You **CAN** be **INJURED** if you **DO NOT** follow directions. It may also be used to alert against unsafe practices.

DAMAGE PREVENTION AND INFORMATION MESSAGES

A Damage Prevention Message is to inform the user of important information and/or instructions that could lead to equipment or other property damage if not followed. Information Messages convey information that pertains to the equipment being used. Each message will be preceded by the word **NOTE**, as in the example below.

NOTE: Equipment and/or property damage may result if these instructions are not followed.

GENERAL SAFETY PRECAUTIONS AND HAZARD SYMBOLS

In order to prevent injury, the following safety precautions and symbols should be followed at all times!

SAFETY PRECAUTIONS



ALWAYS read this Owner's Manual before operating the machine. **DO NOT** operate or service this equipment before reading this entire manual. Read and understand all warnings, instructions and controls on the machine. Know how to stop the equipment quickly in case of emergency. It is the operators responsibility to use this machine under safe working conditions and conform with federal, state and local codes or regulations pertaining to safety, air, pollution, noise etc...

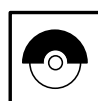

ALWAYS keep the Blade and Belt Guards in place. **DO NOT** operate this machine with any guard or safety device removed. A Guard, or any damaged part should be repaired or replaced immediately.

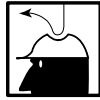

NEVER operate this equipment without proper protective clothing, shatterproof glasses, steel-toed boots and other protective devices required by the job. Non-slip foot wear is recommended.

**PERSONAL PROTECTIVE EQUIPMENT**

ALWAYS wear approved respiratory, head, ear and eye protection when operating this machine.

**ACCIDENTAL STARTS!**

Before starting the engine/motor, be sure the **ON/OFF** switch is in the **OFF** position to prevent accidental starting. Place the **ON/OFF** switch in the **OFF** position before performing any service operation. **ALWAYS** place the power **ON/OFF** switch in the **OFF** position when the saw is not in use.

**ROTATING PARTS**

Keep hands, feet, hair, and clothing away from all moving parts to prevent injury. Never operate the motor with covers, shrouds, or guards, removed.

**HOT PARTS!**

Engine components can become extremely hot from operation. To prevent severe burns, do not touch these areas while the engine is running, or immediately after it is turned off. Never operate the engine with heat shields removed.

**OVER SPEED**

NEVER tamper with the governor components or settings to increase the maximum speed. Severe personal injury and damage to the engine or equipment can result if operated at speeds above maximum.

**ELECTRICAL SHOCK**

NEVER touch electrical wires or components while the engine is running. Exposed, frayed or worn electrical wiring and plugs can be sources of electrical shock which could cause severe injury or burns. Do not touch the plug with wet hands.



ALWAYS avoid inhalation of and skin contact with silica dust and/or mist. Provide proper dust removal. Use dust-collection system when applicable.



NEVER operate the machine in an explosive atmosphere or near combustible materials. Sparks from the cutting-action of this machine can ignite flammable materials, liquids, gases or dust.



This equipment should not be operated by persons under 18 years of age.

**KEEP CHILDREN AWAY**

All visitors and children should be kept a safe distance from work area. Maintain a safe operating distance to other personnel.

**MAKE THE WORKSHOP KID PROOF**

Make the workshops kid proof by using padlocks, master switches or by removing starter keys.

**DO NOT FORCE THE TOOL**

A power tool will do a job better and safer operating at the rate for which it was designed. **DO NOT** force a tool or an attachment to do a job that it was not designed to do.

**USE PROPER APPAREL**

DO NOT wear loose clothing, gloves, neckties, rings, bracelets, or other jewelry that may be caught in moving parts. Non-slip footwear is recommended. Wear protective hair covering to contain long hair.

**SECURE WORK**

Clamps or a vise should be used to hold work whenever practical. Keeping your hands free to operate a power tool is safer.

**DO NOT OVERREACH**

Keep proper footing and balance at all times by not overreaching.

**DISCONNECT TOOLS**

Power tools should always be disconnected before servicing, adjusting or when changing accessories, such as blades, bits, cutters, and the like.

**MAINTAIN TOOLS WITH CARE**

Keep tools clean and maintained for the best and safest performance. Always follow maintenance instructions and examine the machine before use. If any abnormal vibrations or noises occurs, turn off machine immediately and have the problem corrected before further use.

**REMOVE ADJUSTING KEYS AND WRENCHES**

Form a habit of checking to see that keys and adjusting wrenches are removed from the power tool before it is turned on.

**KEEP WORK AREA CLEAN**

Cluttered work areas and benches invite accidents. Keep area around machine clear of obstructions which could cause persons to fall.

**DO NOT USE IN DANGEROUS PLACES**

DO NOT operate equipment in dangerous or hazardous environments. **DO NOT** use power tools in damp or wet locations nor expose them to rain. Always keep the work area well lighted.

**USE RECOMMENDED ACCESSORIES**

Consult the owner's manual for recommended accessories. Using improper accessories may increase the risk of personal or by-stander injury. Unauthorized equipment modifications will void all warranties. Manufacturer does not assume responsibility for any accident due to equipment modifications.



ALWAYS ensure that the machine is on level ground before using.

**NEVER STAND ON THE TOOL**

Serious injury could occur if a power tool is tipped, or if a cutting tool is unintentionally contacted.

**TRANSPORT**

When loading or unloading the machine, use caution. Remove the blade prior to hoisting, loading and transporting the machine.

**CHECK FOR DAMAGED PARTS**

Before using a power tool, check for damaged parts. A guard or any other part that is damaged should be carefully checked to determine if it would operate properly and perform its intended function. Always check moving parts for proper alignment or binding. Check for broken parts and mountings and all other conditions that may affect the operation of the power tool. A guard, or any damaged part, should be properly repaired or replaced. Always check the machine for loose bolts before starting.

**DIRECTION OF ROTATION**

A blade or cutter should always be installed so that rotation is in the direction of the arrow imprinted on the side of the blade or cutter. It should correspond with the rotational direction of the motor. Always feed work into a blade against the direction of rotation.

**NEVER LEAVE A TOOL UNATTENDED**

TURN POWER OFF - Do not leave a tool until it comes to a complete stop. **ALWAYS** turn a power tool **OFF** when leaving the work area, or, when a cut is finished.



NEVER disconnect any "emergency or safety devices". These devices are intended for operator safety. Disconnection of these devices can cause severe injury, bodily harm, or even death! Disconnection of any of these devices will void all warranties. Unauthorized equipment modifications will void all warranties. Manufacturer does not assume responsibility for any accident due to equipment modifications.



NEVER use this machine with any cutter designed for woodworking.



NEVER operate this equipment when not feeling well due to fatigue, illness or taking medicine.



NEVER operate this equipment under the influence of drugs or alcohol.



On belt driven equipment, overtensioning of belts will result in premature crank and/or bearing failure.



Whenever necessary, replace nameplate, operation and safety decals when they become difficult to read.



ALWAYS store equipment properly when it is not being used. Equipment should be stored in a clean, dry location out of the reach of children



DO NOT lend or rent this equipment without including the Owner's Manual and the Engine/Motor Manufacturer's Manual.



Check the chemical properties of the material to be cut/grinded and follow all EPA/OSHA Regulations.

SILICA DUST WARNING

Grinding/cutting/drilling of masonry, concrete, metal and other materials with silica in their composition may give off dust or mists containing crystalline silica. Silica is a basic component of sand, quartz, brick clay, granite and numerous other minerals and rocks. Repeated and/or substantial inhalation of airborne crystalline silica can cause serious or fatal respiratory diseases, including silicosis. In addition, California and some other authorities have listed respirable crystalline silica as a substance known to cause cancer. When cutting such materials, always follow respiratory precautions.

Use appropriate NIOSH-approved respiratory protection where dust hazard may occur. Paper masks or surgical masks without a NIOSH approval number are not recommended because they do little to protect the worker. For more information about respirator programs, including what respirators have received NIOSH approval as safe and effective, please visit the NIOSH website at:
<http://www.cdc.gov/niosh/topics/respirators>

Observe OSHA regulations for respirator use (29 C.F.R. §1910.134).
Visit <http://www.osha.gov> for more information.

CALIFORNIA PROPOSITION 65 MESSAGE

Some dust created by power sanding, sawing, grinding, drilling, and other construction activities contain chemicals known (to the State of California) to cause cancer, birth defects or other reproductive harm. Some examples of these chemicals are:

- Lead, from lead-based paints
- Crystalline silica from bricks, cement and other masonry products
- Arsenic and chromium, from chemically treated lumber

For further information, consult the following sources:
<http://www.osha.gov/dsg/topics/silicacrystalline/index.html>
<http://www.cdc.gov/niosh/docs/96-112/>
<http://oehha.ca.gov/prop65/law/P65law72003.html>
<http://www.dir.ca.gov/Title8/sub4.html>

Your risk from these exposures varies depending on how often you do this type of work. To reduce your exposure to these chemicals, work in a well-ventilated area, and work with approved safety equipment, such as dust masks that are specially designed to filter out microscopic particles. Where use of a dust extraction device is possible, it should be used. To achieve a high level of dust collection, use an industrial vacuum cleaner.



WARNING

Sawing and drilling generate dust. Excessive airborne particles may cause irritation to eyes, skin and respiratory tract. To avoid breathing impairment, always employ dust controls and protection suitable to the material being sawed or drilled; See OSHA (29 CFR Part 1910.1200).

ELECTRICAL REQUIREMENTS AND GROUNDING INSTRUCTIONS

In order to prevent electrical shock and injury, the following electrical safety precautions and symbols should be followed at all times!



WARNING

In case of a malfunction or breakdown, grounding provides a path of least resistance for electrical current to reduce the risk of electric shock. This tool is equipped with an electric cord which has an equipment-grounding conductor and a grounding plug. The plug must be plugged into a matching outlet that is properly installed and grounded in accordance with all local codes and ordinances.

- **DO NOT** modify the plug provided - if it will not fit the outlet, have the proper outlet installed by a qualified electrician.
- Improper connections of the equipment-grounding conductor can result in a risk of electric shock. The equipment-grounding conductor is the insulated conductor that has an outer surface that is green, with or without yellow stripes. If repair or replacement of the electric cord or plug is necessary, **DO NOT** connect the equipment-grounding conductor to a live terminal.
- Check with a qualified electrician or service personnel if the grounding instructions are not completely understood, or if in doubt as to whether the tool is properly grounded.
- Use only 3-wire extension cords that have 3-prong grounding plugs and 3-pole receptacles that accept the tool's plug.
- Repair or replace a damaged or worn cord immediately.

This tool is intended for use on a circuit that has an outlet that looks like the one shown in Sketch A. The tool has a grounding plug that looks like the plug illustrated in Sketch A. A temporary adapter, which looks like the adapter illustrated in sketches B and C, may be used to connect this plug to a 2-pole receptacle as shown in Sketch B, if a properly grounded outlet is not available. The temporary adapter should be used only until a properly grounded outlet can be installed by a qualified electrician. The green-colored rigid ear, plug, and the like, extending from the adapter, must be connected to a permanent ground, such as a properly grounded outlet box.

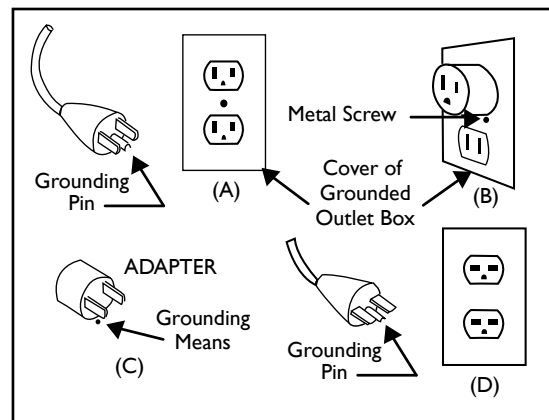

Circuit and Adapter Information

NOTE: Use of a temporary adapter is not permitted in Canada.

NOTE: If permanently connected this tool should be connected to a grounded metal permanent wiring system; or to a system having an equipment - grounding conductor.

ELECTRIC MOTOR SAFETY

For maintenance care and operation of the electric motor, refer to your electric motor instruction booklet furnished with the electric motor. Protect the electric motor from dust as much as possible and keep ventilating openings clean. Before plugging in the machine, make sure that the outlet voltage is within the voltage marked on the machines's data plate.



CAUTION



DO NOT spray water on the electric motor. **DO NOT** touch the plug with wet hands. To reduce the risk of electrocution, keep all connections dry and off the ground.



DO NOT operate electric motor in an explosive environment.



DO NOT EXPOSE TO RAIN

DO NOT expose to rain or use in damp locations.



WARNING



If operating the equipment in damp locations is unavoidable, **ALWAYS** use a Ground Fault Circuit Interrupter, **ALWAYS** wear rubber gloves and footwear in damp conditions.



DO NOT abuse the cord. Never use the cord to carry the equipment or to pull the plug from the outlet. Keep the cord away from heat, sharp edges, and moving parts. Replace damaged cords immediately. Damaged cords increase the risk of electric shock.



WARNING

To reduce the risk of electrocution, keep all connections dry and off the ground. A Ground Fault Circuit Interrupter (GFCI) should be provided on the circuit(s) or outlet(s) to be used for this machine. Receptacles are available having built-in GFCI protections and may be used for this measure of safety. When using an extension cord, GFCI should be installed closest to the power source, followed by the extension cord and lastly, the machine.



WARNING

The water pump requires a GFCI. To reduce risk of electrical shock when operating the machine with the pump plugged into the 3-pole receptacle on the motor, connect the saw to a GFCI outlet. See the pump manual and informational tags enclosed separately for all pump information.

**WARNING**

To avoid the possibility of the appliance or plug receptacle getting wet, position the machine to one side of a wall mounted receptacle. This will prevent water from dripping into the receptacle or plug. A "drip loop," shown in the picture below, should be arranged by the user to properly position the power cord relative to the power source. Use the drip loop as a way to prevent GFCI and plug from getting wet.

The "drip loop" is that part of the cord below the level of the receptacle (or the connector, if an extension cord is used). This method of positioning the cord prevents the travel of water along the power cord and coming in contact with the receptacle.

If the plug or receptacle gets wet, **DO NOT** unplug the cord. Disconnect the fuse or circuit breaker that supplies power to the tool. Then unplug and examine for presence of water in the receptacle.

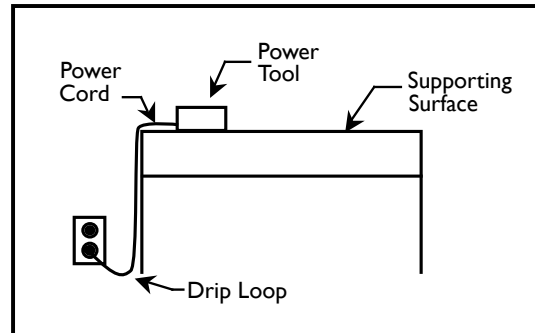

Drip Loop Information

**WARNING**

Use only extension cords that are intended for outdoor use. These extension cords are identified by a marking "Acceptable for use with outdoor appliances; store indoors while not in use." Use only extension cords having an electrical rating not less than the rating of the product. **DO NOT** use damaged extension cords. Examine extension cords before using and replace if damaged. **DO NOT** abuse extension cords and **DO NOT** yank on any cord to disconnect. Keep cords away from heat and sharp edges. Always disconnect the extension cord from the receptacle before disconnecting the product from the extension cord.

ALWAYS make certain that the power source required for the electric motor is correct and always use the correct NEMA configuration plug. Motors can burn out when the line voltage falls 10% below the voltage rating of the motor. Failure to use proper voltage will cause the motor to overheat. Make certain that the correct size grounded (3-wires) extension cord is used.

**WARNING**

Use of undersized extension cords result in low voltage to the motor that can result in motor burnout and premature failure. MK Diamond warns that equipment returned to us showing signs of being run in a low voltage condition, through the use of undersized extension cords, will be repaired or replaced totally at the customer's expense. There will be no warranty claim.

To choose the proper extension cord,

- Locate the length of extension cord needed in the table below.
- Once the proper length is found, move down the column to obtain the correct AWG size required for that length of extension cord.

EXTENSION CORD LENGTH							
Nameplate Amperes	115V	25'	50'	75'	100'	150'	200'
	250V	50'	100'	150'	200'	300'	400'
0 - 5		16	16	16	14	12	12
5.1 - 8		16	16	14	12	10	•
8.1 - 12		14	14	12	10	•	•
12.1 - 15		12	12	10	10	•	•
15.1 - 20		10	10	10	•	•	•

NOTES

SAFETY LABEL LOCATIONS

Safety labels contain important safety information. Please read the information contained on each safety label. These labels are considered a permanent part of your saw. If a label comes off or becomes hard to read, contact MK Diamond or your dealer for a replacement.

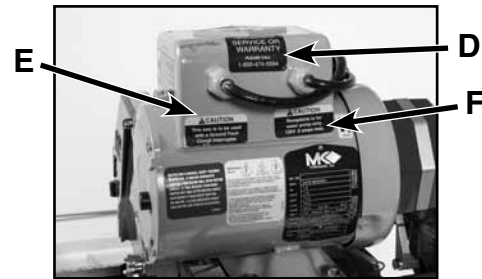
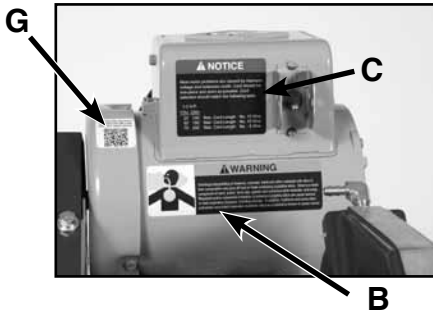

Label A

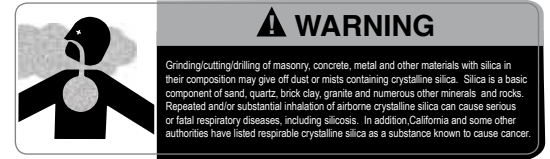

Label B

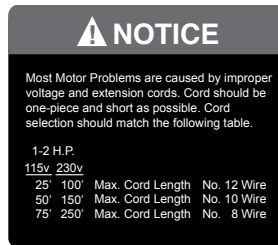

Label C



Label D



Label E

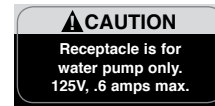

Label F



Label G



Label H

Warning Label Sheet Part # 166012

Decal/Label	Location	Description
A	Motor - Side	Warning - Read and Follow Operating Instructions
B	Motor - Front	Warning - Silica Warning
C	Motor - Front	Notice - Voltage/Extension Cords
D	Motor - Back	Service/ Warranty
E	Motor - Back	Caution - Use with GFCI only
F	Motor - Back	Caution - Receptacle for water pump
G	Motor - Back	QR Code for Manuals
H	Water Pump	Pump Specifications

PRODUCT SPECIFICATIONS

The MK-101-24 is a versatile Tile Saw. Operated and used according to this manual, the unit will provide years of dependable service.

The MK-101-24 is engineered as a table top or stand mounted wet tile saw. The saw include a powerful 120V totally enclosed capacitor start motor with a thermal protective overload.

Specifications for the MK-101-24	
Voltage	120V
Overall Amperage	14.5
Frequency	60Hz
Blade RPM	3400
Horse Power	1-1/2 Hp
Weight	98lbs
Blade Capacity	10" (254 mm)
Arbor Size	5/8" (16 mm)
Depth of Cut (10" Blade)	3" (76 mm)
Length of Cut	24"
Diagonally Cuts	18" Tile
LxWxH (inches)	42" x 21-1/2" x 23"
LxWxH (mm)	1,014 x 546 x 584
Part #	169612

UNPACKING

Your MK-101-24 has been shipped from the factory thoroughly inspected. Only minimal assembly is required.

CAUTION Use proper lifting techniques when lifting the MK-101-24.

NOTE: A silicon plug on the cutting table covers the leveling set screw. This is a factory adjustment to ensure precision cutting.

In your container, you will find one (1) MK-101-24 frame and water basin, one (1) MK-101-24 Cutting Head, one (1) 10-inch wet cutting continuous rim diamond blade, one (1) adjustable cutting guide, one (1) electric water pump, one (1) cooling transfer tube, one (1) flow adjusting clamp, one (1) drain plug, one (1) blade wrench, one (1) splash guard, one (1) tri-knob, one (1) owners manual, one (1) pump manual and one (1) warranty card.

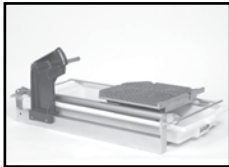

MK-101-24 Frame and Water Basin



MK-101-24 Cutting Head



Diamond Blade



Adjustable Cutting Guide



Electric Water Pump



Cooling Transfer Tube



Flow Adjusting Clamp



Drain Plug



Blade Wrench

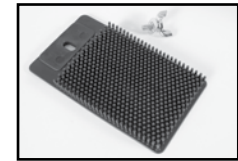

Splash Guard



Tri-Knob



Owners Manual

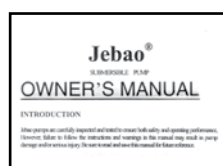

Pump Manual



Warranty Card

TRANSPORT

- ! CAUTION**
1. The MK-101-24 weighs approximately ninety-eight (98) pounds.
 2. Never transport the MK-101-24 with water in the Water Basin.

The MK-101-24 is designed with a rigid frame and removable Cutting Head. Two people are required to transport the MK-101-24 with the Cutting Head installed. Remove the Cutting Head if one person is transporting the saw (see Cutting Head Installation and Removal in the following section).

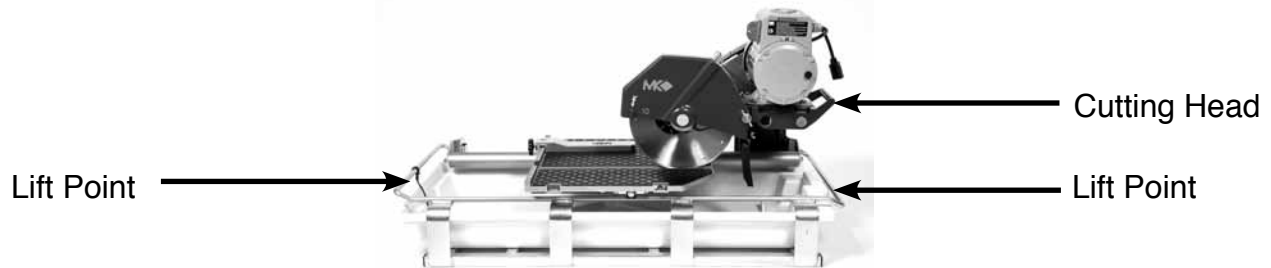

STAND (Optional)

- ! CAUTION** The MK-101-24 weighs approximately ninety-eight (98) pounds; follow the guidelines for transport in the TRANSPORT section, when placing it on the stand.

If using the MK Diamond Stand, Part # 168244, follow these steps.



(A)
Open the stand and place on flat surface

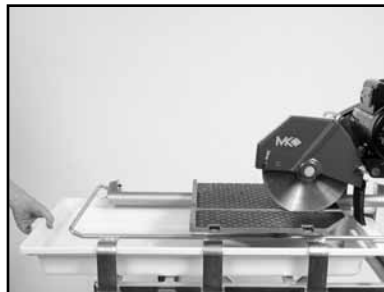

(B)
Remove Water Basin, place saw on stand



(C)
Ensure the back of the saw frame is positioned properly



(D)
The front of the saw frame will extend 7" in front of the stand



(E)
Reinstall the Water Basin

Cutting Head Installation

Follow the assembly instructions to prepare your MK-101-24 for operation.

NOTE: If the cutting head is installed, go to the next step.

CAUTION The cutting head is heavy. Care must be used when installing it.



(A)
Ensure Cutting Head Stop is in upward position.



(B)
Align Cutting Head rear Pivot Hole to the Post Pivot Shaft and slide onto shaft.



(C)
Install the Cutting Head onto the Post Pivot Shaft and install the Adjusting Knob.

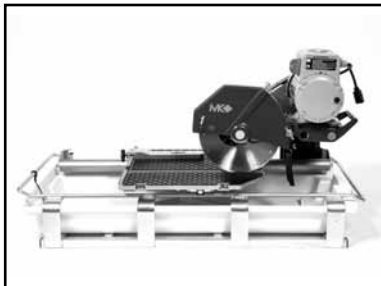

For maximum cutting length, the Cutting Head should be in the front pivot hole and the Post should be in the rear post retaining hole.

NOTE: For small tiles (6" tile or smaller) the Cutting Head should be in the rear pivot hole and the Post should be in the forward post retaining hole. For large tiles and maximum cutting length, the Cutting Head should be in the front pivot hole and the Post should be in the rear post retaining hole.

NOTE: Move Cutting Head Stop in upward position when using rear pivot hole and in the down position when using front pivot hole, refer to page 24.

Diamond Blade Installation

NOTE: When installing the Retaining Nut, do not “cross-thread” and DO NOT over tighten.

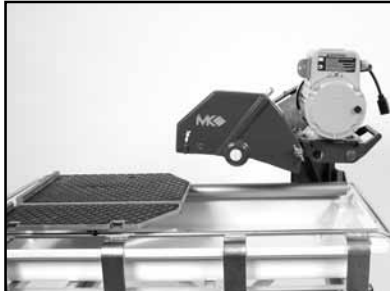

(A)
Position Movable Cutting Table to the front of the saw.

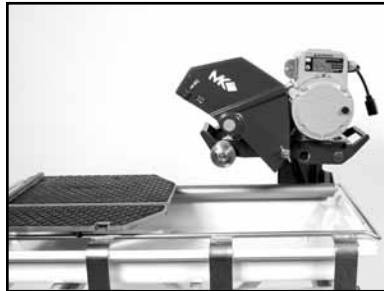

(B)
Raise the Blade Guard by loosening the wingnut.

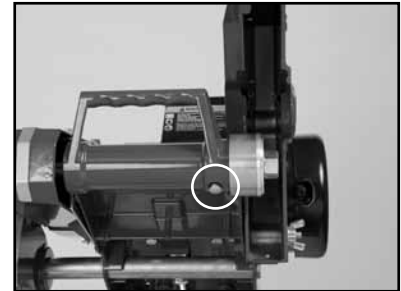

(C)
Locate the Shaft Lock push button on the underside of the Cutting Head.



(D)
Depress and hold the Shaft Lock pushbutton and remove Retaining Nut and Outer Flange using the Blade Wrench.



(E)
Install Diamond Blade onto Blade Shaft.



(F)
Verify the Blade is seated on the Blade Shaft and direction of rotation is correct.

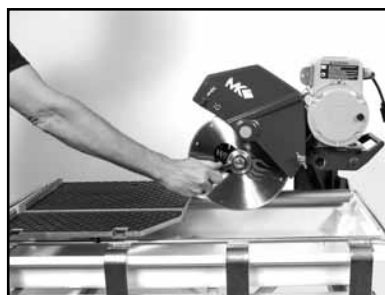

(G)
Install Retaining Nut and Outer Flange, depress and hold the Shaft Lock pushbutton and tighten Retaining Nut.

Adjustable Cutting Guide Installation

NOTE: The Adjustable Cutting Guide can be used on either side of the Diamond Blade.



(A)

Place the Adjustable Cutting Guide onto the Movable Cutting Table Ruler/Stop and tighten the retaining thumbscrew.

Splash Guard Installation



(A)

Install the retaining thumbscrew through the washer and Splash Guard then align to the hole found on back of the Blade Guard.



(B)

Install the Splash Guard onto the Blade Guard.

Water Pump Preparation



(A)

Install Water Pump Discharge Fitting.



(B)

Press one end of the Cooling Transfer Tube onto the Water Pump Discharge Fitting.

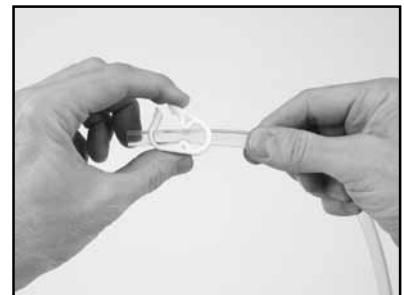

(C)

Slide Cooling Flow Adjusting Clamp onto the Cooling Transfer Tube.

Pre-start Inspection

Prior to beginning work, a pre-start inspection of the saw should be performed.



(A)
Ensure the ON/OFF Switch is in the OFF position.



(B)
Verify the Movable Cutting Table moves freely.

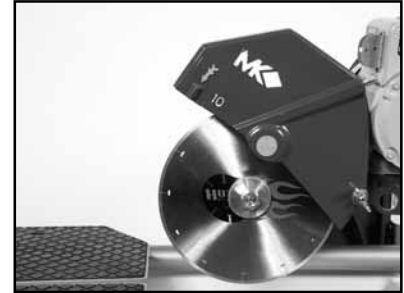

(C)
Inspect the Diamond Blade for damage – verify the blade is correct for the material being cut.



(D)
Inspect the Pump Assembly for damage – ensure the cord is free of cracks or cuts.



(E)
Inspect the MK-101-24 for damage – ensure the cord is free of cracks or cuts.

Connecting the Water Pump



WARNING

1. To prevent the possibility electrical shock, the MK-101-24 MUST be de-energized when connecting the Water Pump.
2. To prevent the possibility of electrical shock, use only MK Diamond qualified replacement parts.

NOTE:

To prevent pump damage, the Water Pump must be disconnected during dry cutting operations.



(A)
Connect the Cooling Transfer Tube to the inlet connection of the Blade Guard.



(B)
Connect the Water Pump power cord to the connection found on the back of the motor.

Water Pump Setup for Operation

The Water Pump can be setup for operation in two ways, External Water Source or Re-circulation.

NOTE: If using a dry blade for operation, DO NOT connect the water pump.

External Water Source

This is the preferred method of cooling.



(A)

Remove the Drain Plug. Place empty container under hole for water drainage.



(B)

Place the Water Pump in an external container and fill until water completely covers the Water Pump suction.

Re-circulation

NOTE: When using the re-circulation method, the water should be changed often for longer pump life

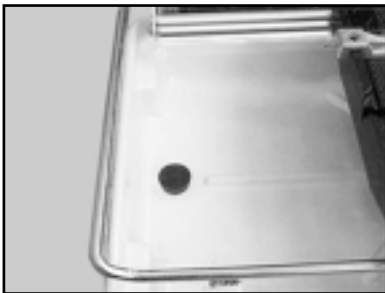

(A)

Ensure the Drain Plug is installed in the Water Basin.



(B)

Place Water Pump in Water Pan. Fill the Water Basin until water completely covers the Water Pump suction.

SETUP FOR OPERATION



CAUTION

1. Before powering or starting, check for damage that could prevent this equipment from proper operation or performing its intended function. Check for binding and proper alignment of moving parts. Check for damaged, broken, or missing parts.
2. Verify the On/Off switch is in the OFF position.
3. Before connecting the MK-101-24 to a power supply, be sure the voltage, cycle and phase of the job site power source meet these requirements.

VOLTAGE:	120V
CYCLE:	60hz
PHASE:	1-phase

4. If using an extension power cord, make sure, the length and wire gauge correspond to the requirements listed in on page 12. An extension power cord that is too small in wire gauge (diameter), or too long in length, will cause the motor to overheat and could cause premature failure.
5. Use an approved Ground Fault Circuit Interrupter (GFCI)
6. Do not cover the motor vents as this could lead to motor overheating.

NOTE: In order to avoid breaker tripping, a 20-amp circuit breaker should be used.

PORTABLE GENERATOR

If using a portable generator, ensure the generator meets the following minimum requirements:
 5 KW 120/240 volts 41.7/20.8 amps Single Phase

ELECTRIC RECEPTACLE

NOTE: A GFCI wall socket is the preferred protective device.



(A)
Ensure the ON/OFF Switch is in the OFF position.



(B)
Plug MK-100 into the GFCI.



(C)
Plug the GFCI into the power source.

Set Cutting Depth



CAUTION

When loosening the Cutting Head Adjusting Knob, the Cutting Head will pivot down unless held.



(A)
Loosen Cutting Head Adjusting Knob.

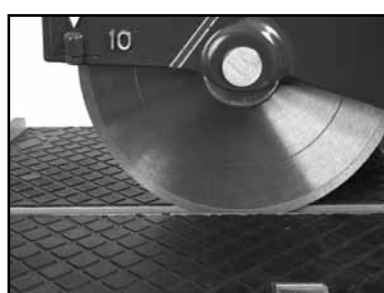

(B)
Set cutting depth approximately 1/4 to 1/2 inch below the surface of the Movable Cutting Table.



(C)
Tighten the Adjusting Knob.

Cutting Straight Edges



CAUTION

DO NOT FORCE THE TOOL. It will do the job better and safer at the rate for which it was designed.

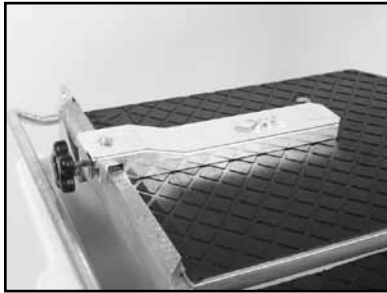

(A)

Position the Adjustable Cutting Guide to desired cut length.

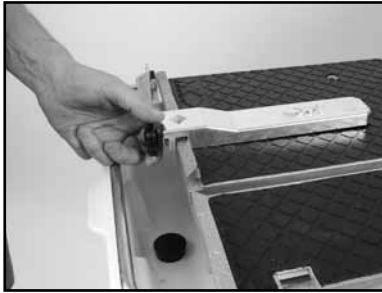

(B)

Tighten the retaining thumbscrew.



(C)

Place the tile against the Ruler/Stop and Cutting Guide. Turn the motor ON.



(D)

Verify proper cooling flow on both sides of the blade (See Maintenance Section to increase/decrease flow).



(E)

Perform the cut. Turn the motor OFF when work is complete.

Diagonal Cutting (Optional)

NOTE: To cut diagonal, the Dual 45° Flat Angle Guide (MK Diamond Part No. 134577-MK) should be used.



CAUTION

DO NOT FORCE THE TOOL. It will do the job better and safer at the rate for which it was designed.



(A)
Remove the Adjustable
Cutting Guide.

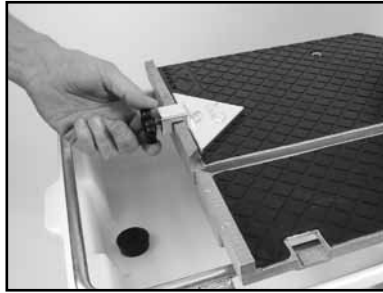

(B)
Position the Dual 45° Flat Angle
Guide and tighten the
retaining thumbscrew.



(C)
Position the tile against the
Guide and Ruler/Stop. Turn the
motor on.



(D)
Verify proper cooling flow on
both sides of the blade (See
Maintenance Section to
increase/decrease flow).



(E)
Perform the cut. Turn the motor
OFF when work is complete.

45° Miter Cutting (Optional)

NOTE: To cut 45° Miters, the 45° Bullnose Miter Guide (MK Diamond Part No. 153201-MK) should be used.

CAUTION **DO NOT FORCE THE TOOL.** It will do the job better and safer at the rate for which it was designed.



(A)
Position the 45° Bullnose Miter Guide and tighten the retaining thumbscrew.



(B)
Position the tile on the 45° Bullnose Miter Guide and the Ruler/Stop. Turn the motor ON.

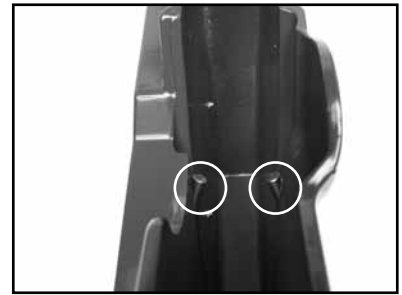

(C)
Verify proper cooling flow on both sides of the blade (See Maintenance Section to increase/decrease flow).



(D)
Perform the cut. Turn the motor OFF when work is complete.

Off-angle Cutting (Optional)

NOTE: To cut angles other than 45° angles or Miters, a 90° Protractor (MK Diamond Part No. 134569-MK) should be used.



CAUTION

DO NOT FORCE THE TOOL. It will do the job better and safer at the rate for which it was designed.

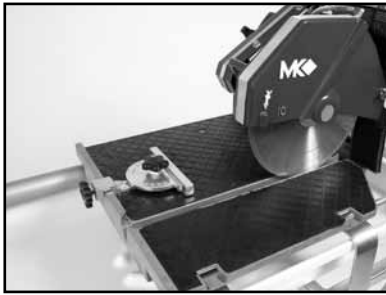

(A)

Place the 90° Protractor on the Ruler/Stop.



(B)

Set the desired angle and tighten the thumbscrew.

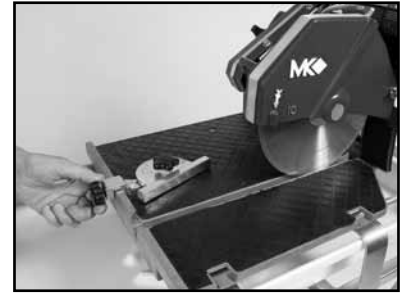

(C)

Position the 90° Protractor and tighten the retaining thumbscrew.



(D)

Position the tile against the 90° Protractor and the Ruler/Stop. Turn the motor ON.

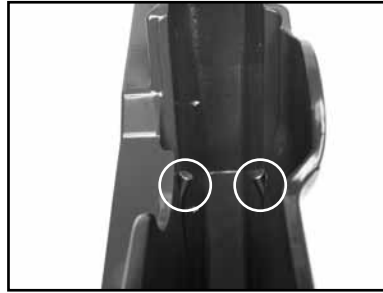

(E)

Verify proper cooling flow on both sides of the blade (See Maintenance Section to increase/decrease flow).



(F)

Perform the cut. Turn the motor OFF when work is complete.

Adjusting the Cutting Head

NOTE: For larger tiles and maximum cutting length, the cutting head should be in the front pivot hole.



CAUTION

The Cutting Head is heavy! Care must be used when changing the position of the Cutting Head.



(A)
Ensure the ON/OFF Switch is in the OFF position. Unplug the GFCI from the power source.



(B)
Remove the Blade.
Remove Adjusting Knob.



(C)
Remove the Cutting Head from the rear pivot hole.



(D)
Install the Cutting Head onto the front pivot hole.

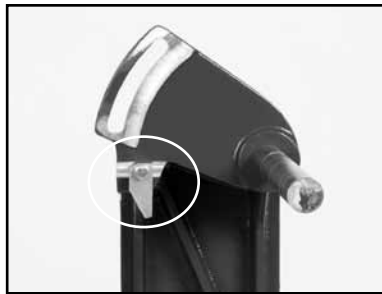

(E)
Remove the Cutting Head Stop Bolt. Rotate Cutting Head Stop to down position and re-tighten Cutting Head Stop Bolt.



(F)
Install the Adjusting Knob.

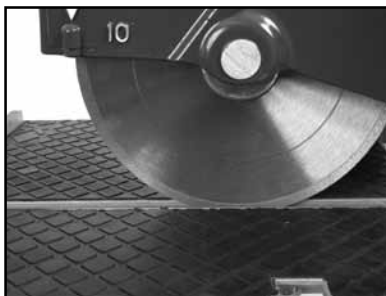

(G)
Set cutting depth approximately 1/4 to 1/2 inch below the surface of the Movable Cutting Table.

NOTE: For small tiles (6" tile or smaller) the Cutting Head should be in the rear pivot hole and the Post should be in the forward post retaining hole. For large tiles and maximum cutting length, the Cutting Head should be in the front pivot hole and the Post should be in the rear post retaining hole.

NOTE: Move Cutting Head Stop in upward position when using rear pivot hole and in the down position when using front pivot hole.

Adjusting the Post for Maximum Cutting Length

CAUTION

The Cutting Head and Post are heavy! Use care when changing the position of the Cutting Head.

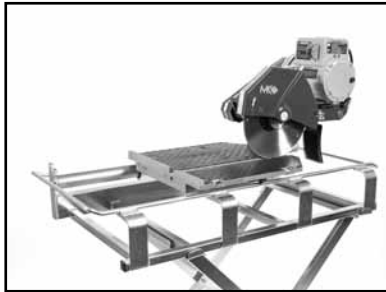

(A)
Remove Water Basin and Blade.



(B)
Remove the Cutting Head (See Adjusting the Cutting Head).



(C)
Loosen the Post Support and retaining bolts.

CAUTION

Hold the Post when removing the Post Support Plate.



(D)
Remove the Post Support and Retaining Bolts.



(E)
Remove and relocate the Post to the rear Post retaining holes.

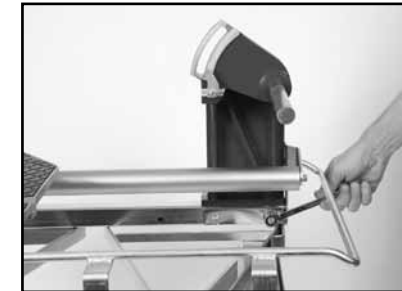

(F)
Install and tighten the Post Support and retaining bolts.



(G)
Install the Cutting Head (See Adjusting the Cutting Head)

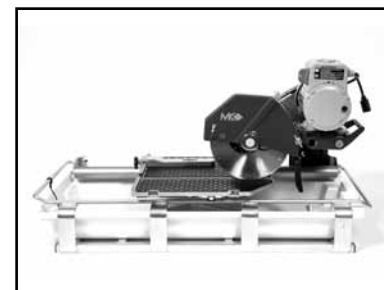

(H)
Install the Water Basin and Blade.

CLEANUP

- NOTES**
1. If an external water source was used, steps A through C may be skipped.
 2. Dispose of waste water in accordance with applicable Federal, State and Local laws.



(A)
Place the Water Pump
in an external container.

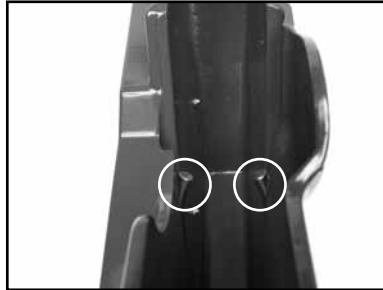

(B)
Run the saw until clear
water is seen at the blade
cooling ports
(Approx. 1 minute).

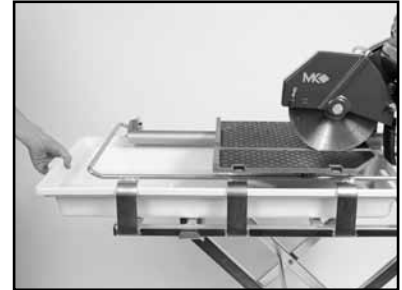

(C)
Remove the Water Basin.



CAUTION

Ensure the saw is disconnected before completing the remainder of the cleanup process.



(D)
Clean the Movable Cutting
Table Guide Bar.



(E)
Clean the Movable Cutting
Table Roller Wheel Frame
Support.



(F)
Clean the remainder of
the saw.



CAUTION

Ensure water is not forced into the motor casing when cleaning.

MAINTENANCE

Perform the following after initial purchase and operation of the MK-101-24.



(A)

Check and adjust V-belt tension following first 48 hours of operation (See V-belt Inspection).

Maintenance Following Use

To extend the life of the MK-101-24, the following procedure should be performed after each use. Lubricate all points listed below with light oils such as, 3 in 1, WD-40, etc.

**CAUTION**

Ensure the saw is off and disconnected before performing any maintenance.



(A)

Lubricate the Guide Bar.



(B)

Lubricate the Roller
Wheel Assembly.

Monthly Maintenance

The following maintenance should be performed Monthly.



(A)
Remove the Diamond Blade.



(B)
Lubricate the Outer Flange
and Retaining-nut.



(C)
Lubricate the Arbor Shaft.



(D)
Verify the Roller Wheel
Assembly is tight and in
good condition.



(E)
Verify all motor mounting
Bolts are tight.



(F)
Verify the Motor Adjustment
Strap is tight.



(G)
Remove the Blade Guard.



(H)
Lubricate the Blade Guard
Pivot Shaft.



(I)
Remove the Cutting Head (See
Adjusting the Cutting Head).



(J)
Lubricate the Cutting Head
Adjustment Knob.



(K)
Lubricate the Cutting Head
Adjustment Knob retaining
holes.



(L)
Lubricate the Cutting Head
Pivot Shaft.

Flow Adjustment

NOTE: If flow to the diamond blade requires adjustment, perform the following actions.

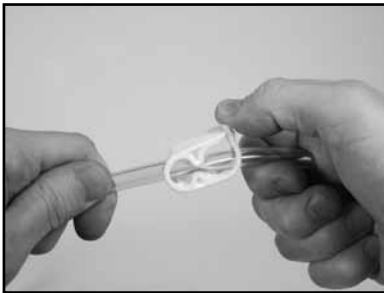

(A)
Increase cooling flow by releas-
ing the Flow Adjusting Clamp.

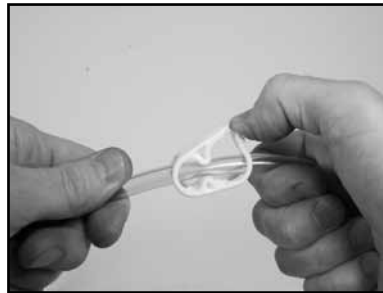

(B)
Reduce cooling flow by
Pressing down on the Flow
Adjusting Clamp.

Blade Dressing

Like most cutting instruments, a diamond blade performs best when it is dressed. Over time and use, diamonds on the outer edge of the blade will become smoothed or "glazed" over. This will reduce grinding efficiency and may cause the blade to "wander" or bend giving the illusion of an alignment problem. When this occurs, the blade will need to be dressed. The diamond blade can be dressed using the MK Dressing Stick (MK Diamond Part No 152792) and by following the steps below.



(A)
Setup the MK100 for operation
(See Setup, Adjustment
and Operation).



(B)
Set the Adjustable Cutting
Guide to cut a 1/16-strip.



(C)
Position the Dressing Stick. Cut
2 or 3 strips from the dressing
stick to dress the Blade.

Diamond Blade Change-out

NOTE: When installing the Retaining Nut, do not "cross-thread" and DO NOT over tighten the nut.

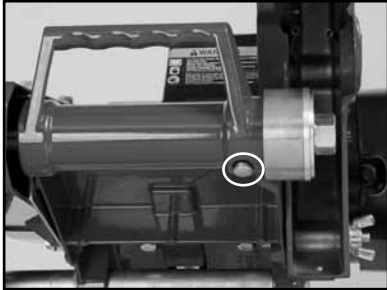

(A)

Locate the Shaft Lock push button on the underside of the Cutting Head



(B)

Remove Retaining Nut and Outer Flange, depress and hold the Shaft Lock hold button and loosen



(C)

Remove the Diamond Blade



(D)

Install the new Diamond Blade onto Blade Shaft. Install Outer Flange and Retaining Nut



(E)

Verify the Blade is seated on the Blade Shaft and direction of rotation is correct

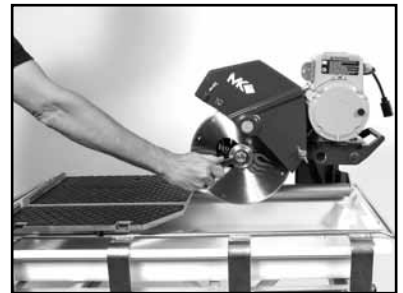

(F)

Depress and hold the Shaft Lock button and tighten Retaining Nut

Micro-V Belt Inspection, Adjustment and Replacement

The MK-101-24 is designed with power transmission Micro-V Belt. In order to ensure the MK-101-24 operates a peak efficiency, the Micro-V Belt should be inspected monthly, and changed if the Micro-V Belt shows damage and/or excessive wear.

NOTE: When a new belt is installed, it should be inspected and re-tensioned after the first forty-eight (48) hours of operation.

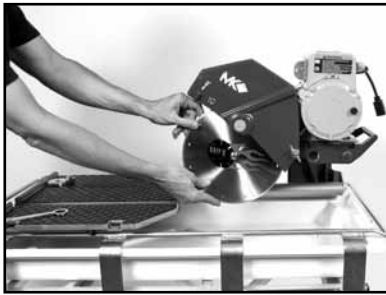

(A)
Remove the Diamond Blade



(B)
Remove the Cutting Head (See
Adjusting the Cutting Head)



(C)
Remove the two top Belt Guard
Bolts



(D)
Remove Belt Guard bottom bolt



(E)
Inspect the Micro-V Belt for cracks,
fraying, separation and wear. Go to
step H if replacement is required

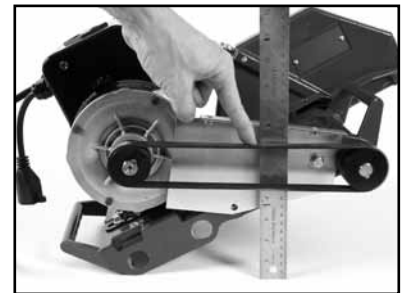

(F)
Check belt for proper tension. If tension
correct, go to step Q (proper tension
should be 1/8-inch
deflection)



(G)
Loosen the two front motor
mounting bolts. If re-tensioning
only, go to step N



(H)
Loosen the two back motor
mounting bolts



(I)
Loosen the Motor Adjustment Strap



(J)
Push the motor toward the front of the Cutting Head to loosen the Micro-V Belt

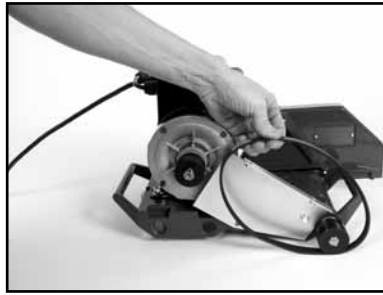

(K)
Remove the Micro-V Belt



(L)
Install the new Micro-V Belt (MK Diamond Part No. 158194)



(M)
Verify the Micro-V Belt is seated in the grooves of both pulleys



(N)
Tighten the Motor Adjustment Strap to remove slack

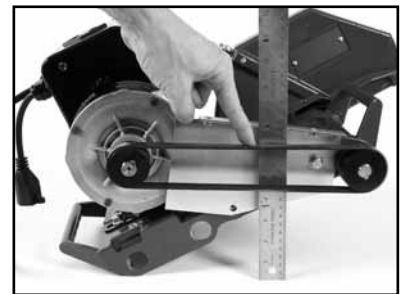

(O)
Check Micro-V Belt tension (proper tension 1/8-inch) Repeat steps N and O until proper Micro-V Belt tension is achieved



(P)
Tighten the four motor mounting bolts



(Q)
Install the Belt Guard

Blade will not cut properly

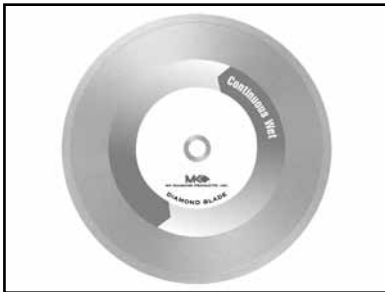

(A)
Check for Smoothness
or "Glazing" (Dress blade
if needed).



(B)
Check for proper blade rotation.

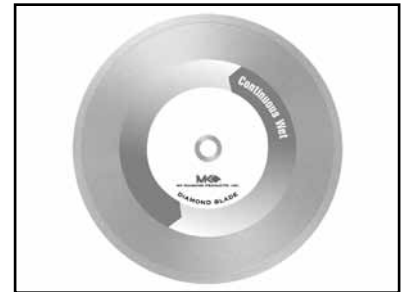

(C)
Ensure the Blade Core
is not bent.



(D)
Verify the blade is correct for
the material being used.

Movable Cutting Table Does Not Move Correctly



(A)
Check the Guide Bar and
Frame for cleanliness –
clean if dirty.



(B)
Check the Movable Cutting
Table Roller Wheels for wear –
replace if necessary.

Cooling Flow

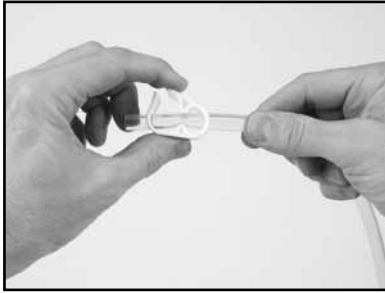

(A)
Verify the cooling flow
Adjusting Clamp is open. If flow
exists, go to Step B.



(B)
Remove the Cooling Transfer
Tube from the Blade Guard
inlet. Go to Step C.



(C)
Place Pump into a bucket of
water and check flow. If flow
exists, go to Step D.



(D)
Remove the Cooling Transfer
Tube and check for flow. If flow
exists, refer to water pump
manual.



(E)
Remove the Blade Guard
Intake Fitting. Go to Step F.



(F)
Remove the Cooling Channel
cover screws. Go to step G.



(G)
Rod the Cooling Channels
and then recheck flow.

NOTE:

“Rodding” cooling channels is performed by inserting a small wire rod through the cooling inlet on top of the Blade Guard and directing the rod out through each of the cooling flow tubes located on the underside of the Blade Guard. The cooling channels should be “rodded” until all ports are free of foreign debris.

Blade Stops Turning



(A)

Allow motor to cool and depress motor Overload Reset Switch

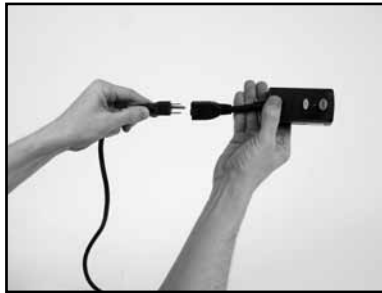

(B)

Verify all plugs fully installed. Check Ground Fault Circuit Interrupter

NOTE: Verify circuit breaker at least 20 amps - if not, move to 20-amp circuit. Verify circuit breaker not tripped. If tripped, reset once. Check power source voltage is 120V - if not 120V, move to another circuit.

Blade Alignment Procedure

The Movable Cutting Table of the MK-101-24 may become misaligned with the Cutting Head of the Tile Saw over time. Should misalignment occur, perform the following steps to realign the Tile Saw.

NOTE: If alignment problems are the result of a warped blade, a bent frame or bent support arm, or, if alignment is off by more than 1/8-inch, contact the MK Diamond Service Center – (800) 474-5594

Tools Needed



(A)

Combination square (square)
12-inch or greater. 1/2-inch
Wrench or MK Triple Hole Box
Wrench and MK Open
End Wrench.

Preparation for Alignment

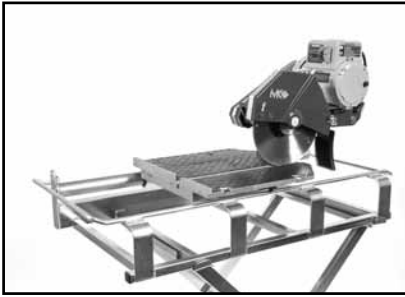

(A)
Remove Water Pan.



(B)
Inspect Diamond Blade
for damage.



(C)
Loosen front and rear
Guide Bar Retaining Bolts.

Horizontal Rough Alignment

The Horizontal alignment will ensure that straight cuts (or Rip Cuts) are made.

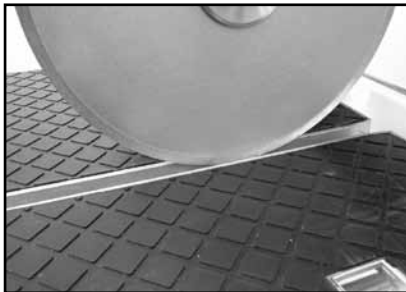

(A)
Position Cutting Head
to normal Cut Depth.

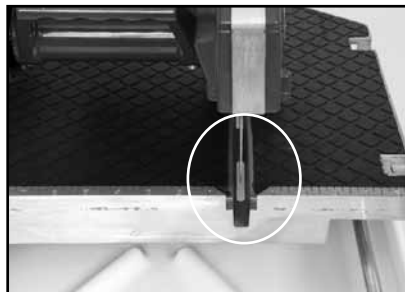

(B)
Move Guide Bar until Blade is
centered in Cutting Groove. Tighten
rear guide bar retaining bolt.



(C)
Pull Movable Cutting Table
to front of Tile Saw.



(D)
Position Square flat on Movable
Cutting Table against Ruler/Stop.
Position front of Square
against Blade.



(E)
Move Guide Bar until Square
rests evenly across Blade.

Horizontal Alignment Verification



(A)

Move the Cutting Table back and forth to verify Blade is even across all points of Square.



(B)

Tighten Guide Bar Retaining Bolts.



(C)

Move the Cutting Table back and forth to re-verify Blade is even across all points of Square.

90° Alignment Verification

90°-alignment verification ensures the blade cuts tile straight up and down and not at an angle. The diamond blade must be removed and reinstalled when removing the blade guard.

NOTE: If the blade is misaligned following 90°-alignment verification, return the saw to MK Diamond for repair.

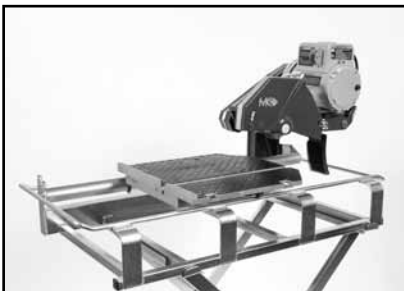

(A)

Remove Blade Guard and water pan.



(B)

Position Square on Movable Cutting Table against the Diamond Blade.

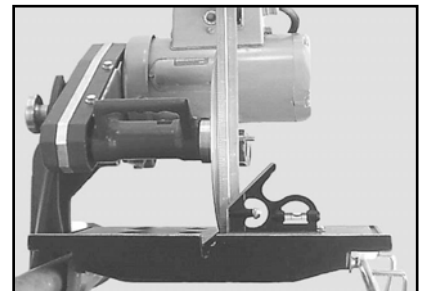

(C)

Verify the Diamond Blade is Square to the Movable Cutting Table.



(D)

If not Square, loosen Movable Cutting Table Wheel Assembly to adjust. Move Wheel Assembly up or down to Square the Movable Cutting Table.



(E)

After Squaring, tighten Movable Cutting Table Wheel Assembly.



(F)

Re-verify the Diamond Blade is Square to the Movable Cutting Table.

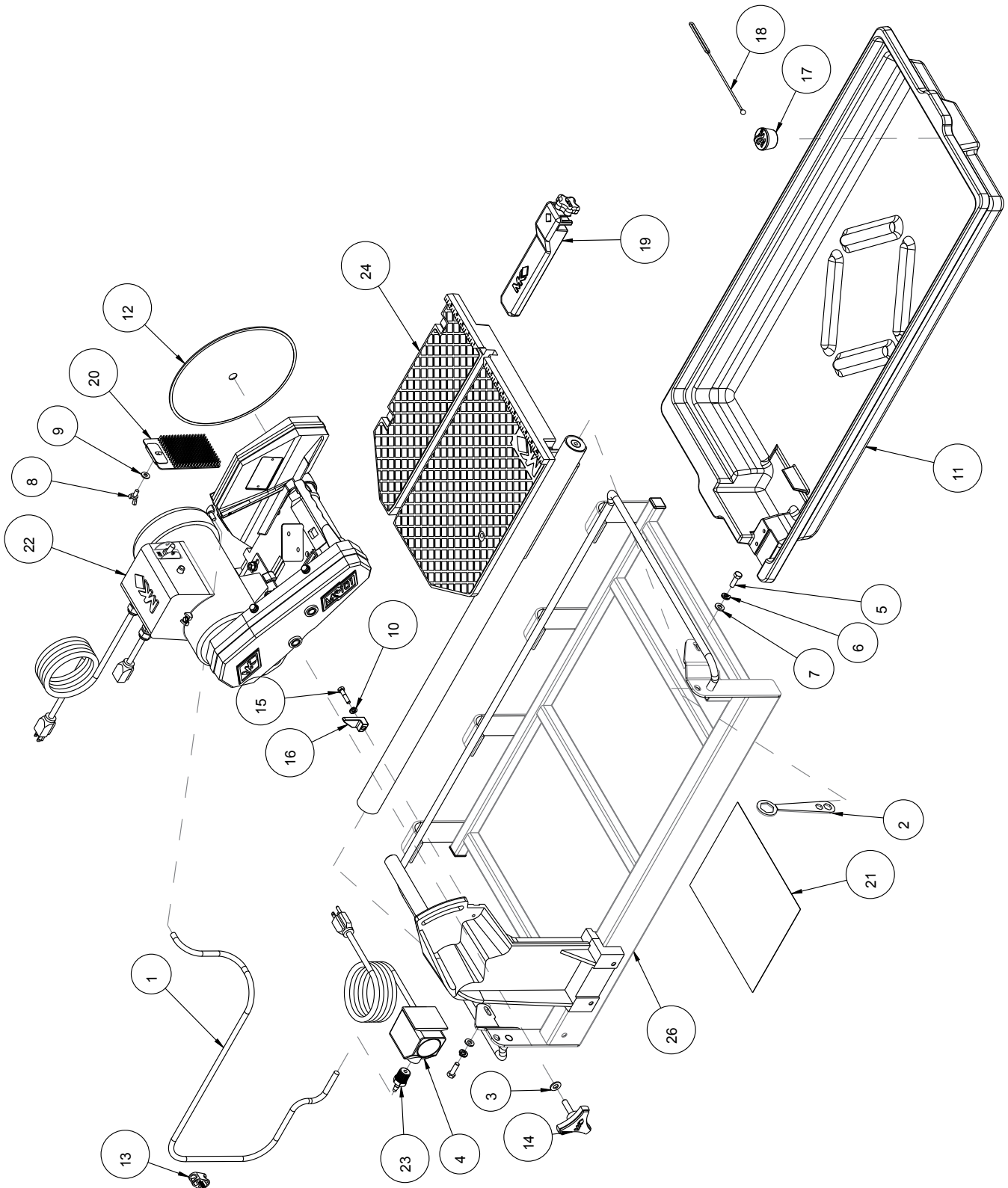

ITEM #	DESCRIPTION	PART #	QTY.
1	HOSE, VINYL, 1/4 X 3/8 (6.0')	132951	1
2	WRENCH, TILE SAW NUT 15/16	134684	1
3	WASHER, FLAT, SAE, 3/8	150923	1
4	PUMP, WATER 115V/60HZ UL/CSA	151271-VP	1
5	SCREW, HEX HD, 5/16 - 18 X 1	151743	2
6	WASHER, LOCK, SPLIT, 5/16	151747	2
7	WASHER, FLAT, SAE, 5/16	151754	2
8	SCREW, WING, 1/4 - 20 X 1/2	151888	1
9	WASHER, FLAT, SAE, 1/4	151915	1
10	WASHER, LOCK, SPLIT, 1/4	152591	1
11	PAN, WATER	153262	1
12	MK-100 10 x 060 x 5/8	154380	1
13	CLAMP, HOSE, 1/4 - 1/2 FLOW	154394	1
14	KNOB, TRI PLASTIC MK-660 1 - 1/2	156770-02	1
15	SCREW, HEX HD 1/4 - 20 X 1 - 1/4	157145	1
16	STOP, CUTTING HEAD	157728	1
17	DRAIN PLUG, W/RING	159529	1
18	STRAP, 9" DRAIN PLUG	159530	1
19	RIP GUIDE, LARGE DIE CAST	159751	1
20	GUARD, SPLASH	160310	1
21	SHEET, WARNING LABELS, TILE SAW	166012	1
22	ASSY, CUTTING HEAD, MK-101	168167	1
23	ADAPTER, 1/2 NPT X 1/4 BARB	168261	1
24	ASSY, TABLE, 101-24 STD	169598	1
25	ASSY, CARTON, MK101 PRO24 2011	169708	1
26	ASSY, FRAME AND POST, 101PRO24	170477	1

Table Assembly
Part# 169598

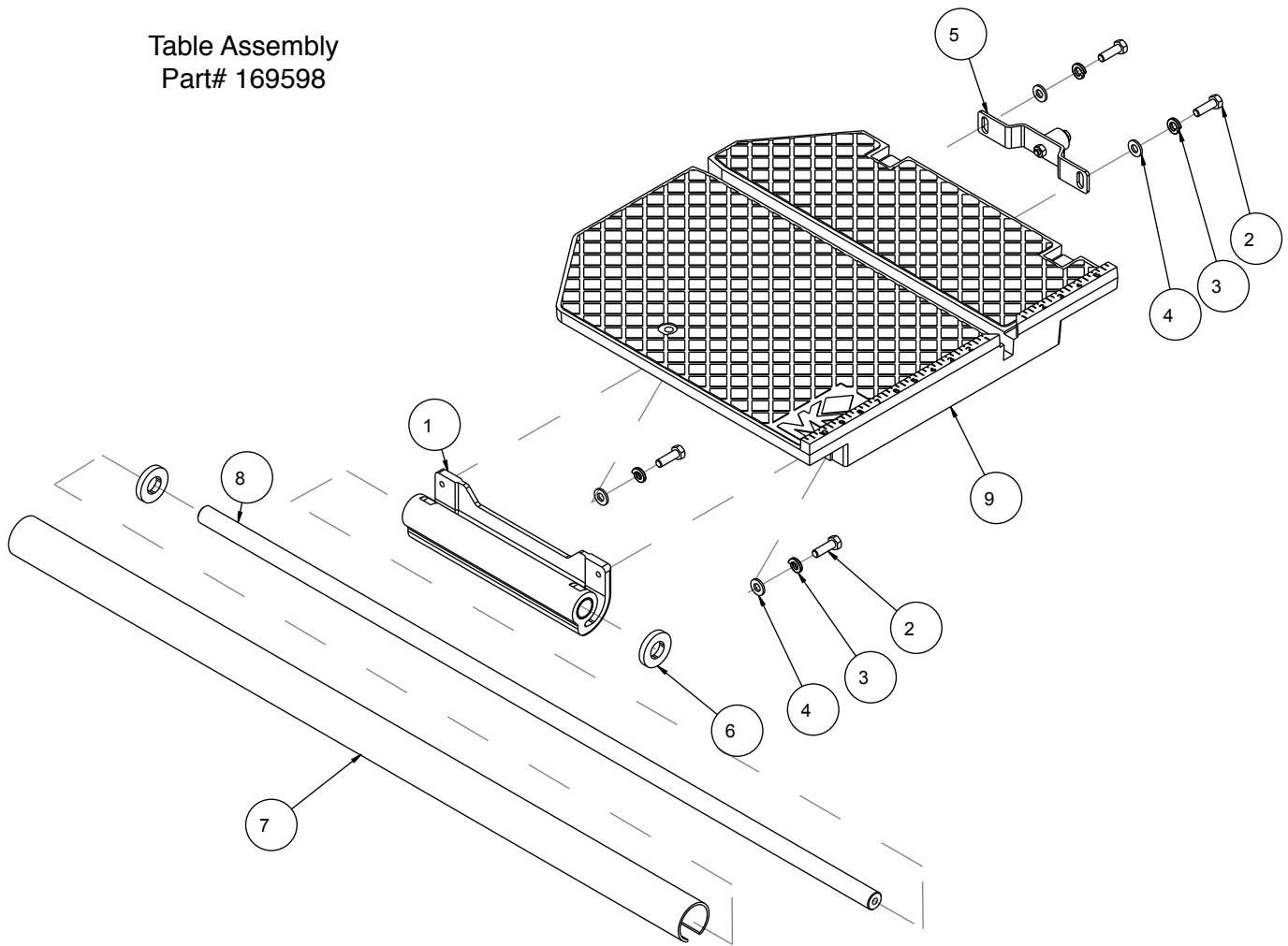

ITEM #	DESCRIPTION	PART #	QTY.
1	CASTING, 101/990 LNR BRG MT-COM	135855	1
2	SCREW, HEX HD, 5/16-18X1	151743	4
3	WASHER, LOCK, SPLIT, 5/16	151747	4
4	WASHER, FLAT, SAE, 5/16	151754	4
5	ASSY, WHEEL BRKT TSAW	151756	1
6	SPACER, GUIDE BAR COVER, COMMON	152393	2
7	COVER, 3/4 X 37 GUIDE BAR	153219	1
8	BAR, 3/4 X 37 LINEAR GUIDE, 101	153492	1
9	CAST, TABLE, PRO24, OVRMLD-COMP	161182	1

Assy, Frame
Part# 170477

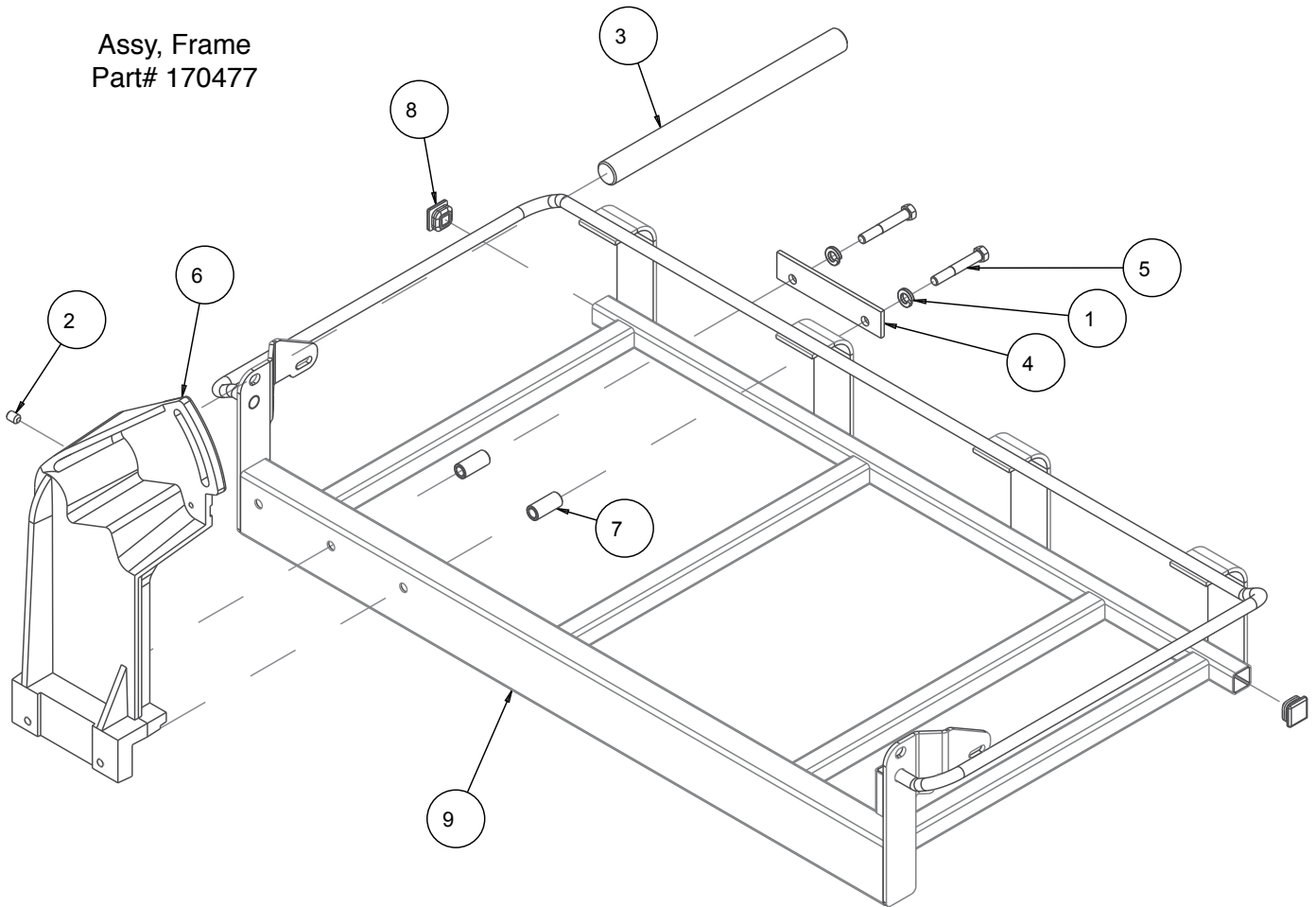

ITEM #	DESCRIPTION	PART #	QTY.
1	WASHER, LOCK, SPLIT, 3/8	150925	2
2	SCREW, SET, SOC, CUPT, 3/8-16X1/2	153710	1
3	SHAFT, 12.88 PIVOT	155530	1
4	PLATE, PRESSURE	155671	1
5	SCREW, 3/8-16 X 2-1/2 HEX HEAD CAP	156030	2
6	CASTING, POST, PRO24 OFFSET-COMP	158405	1
7	SPACER, 5/8 X .385 X 1/4	160654	2
8	PLUG, PLASTIC, 1 SQ-14-20 GA	160727-1	2
9	FRAME, 10" TILE SAW, 24" RIP	168021-24	1

Cutting Head Assembly
Part# 168167

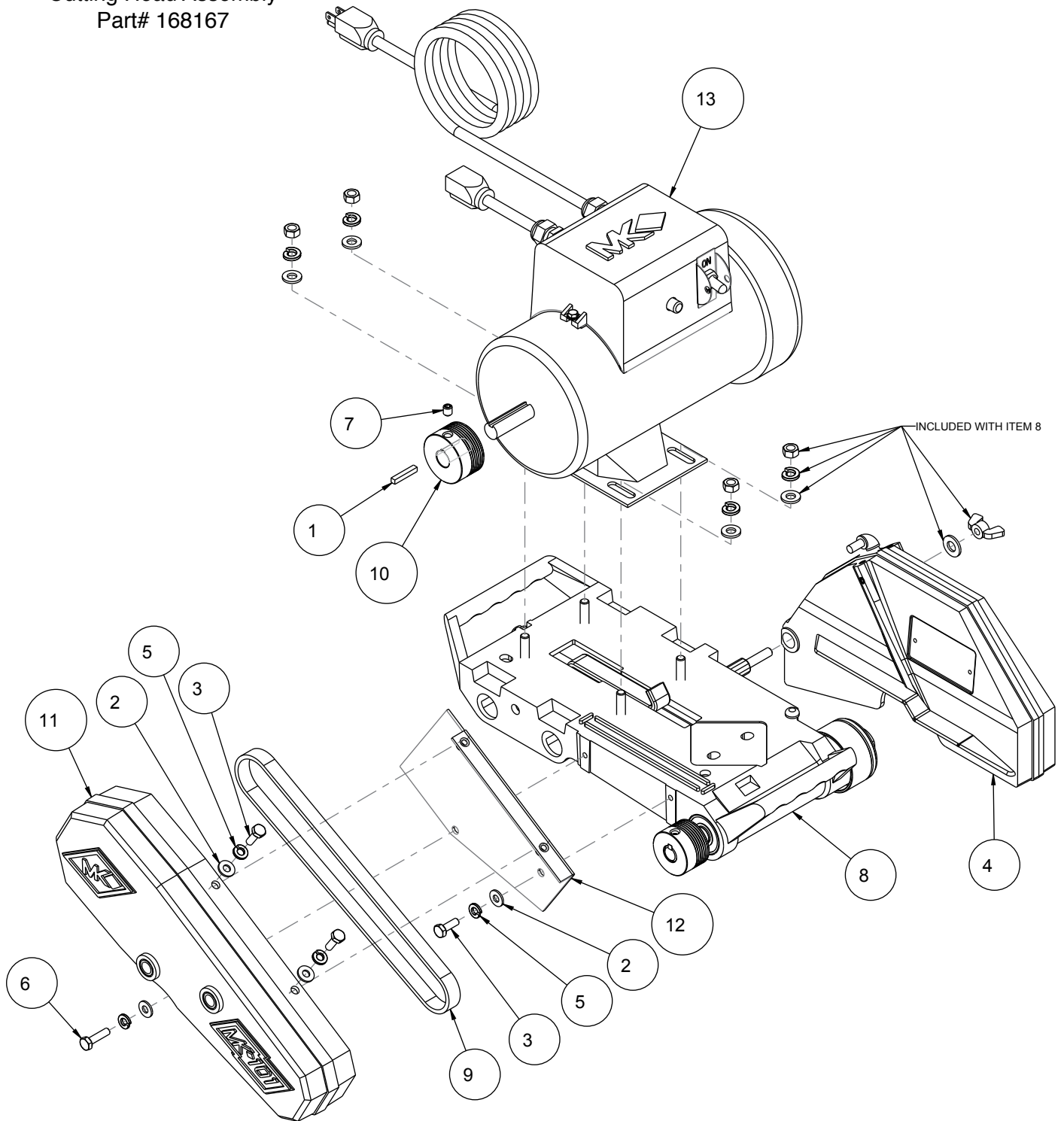

ITEM #	DESCRIPTION	PART #	QTY.
1	KEY, 3/16 SQ X 1 - 18	150344	1
2	WASHER, FLAT, SAE, 1/4	151915	4
3	SCREW, HEX HD, 1/4 - 20 X 3/4	152370	3
4	ASSY, BLADE GUARD, 101	152582	1
5	WASHER, LOCK, SPLIT, 1/4	152591	4
6	SCREW, HEX HD, TAP, 1/4 - 20 X 1	152676	1
7	SCREW, 5/16 - 18 X 3/8 SOCKET HEAD SET	157083	1
8	ASSY, SUB, CUTTING HEAD MK-101	158191	1
9	BELT, 6J260	158194	1
10	PULLEY, 6J19 X 5/8 BORE	158199	1
11	CASTING, 101 BELT GUARD - COMP	158319-01	1
12	BRACKET, INNER BELTGUARD	158611	1
13	MTR, 1 - 1/2HP, 115V, 3400 RPM	168022	1

Blade Guard
Part# 152582

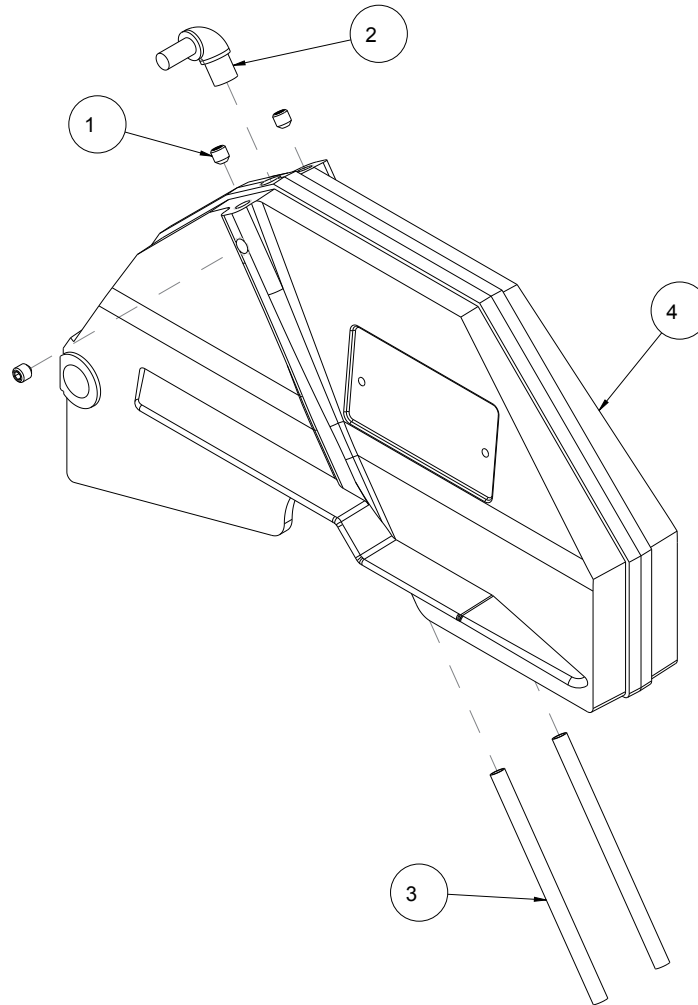

ITEM #	DESCRIPTION	PART #	QTY.
1	SCREW, 5/16 - 18 X 1/2 SOCKET HD SET	152607	3
2	ELBOW, 1/2MNPT X 1/4 BARB, 90 DEG	154652	1
3	TUBE, WATER	155389	2
4	CASTING, 101 BLD GUARD-DC-COMP	162481	1

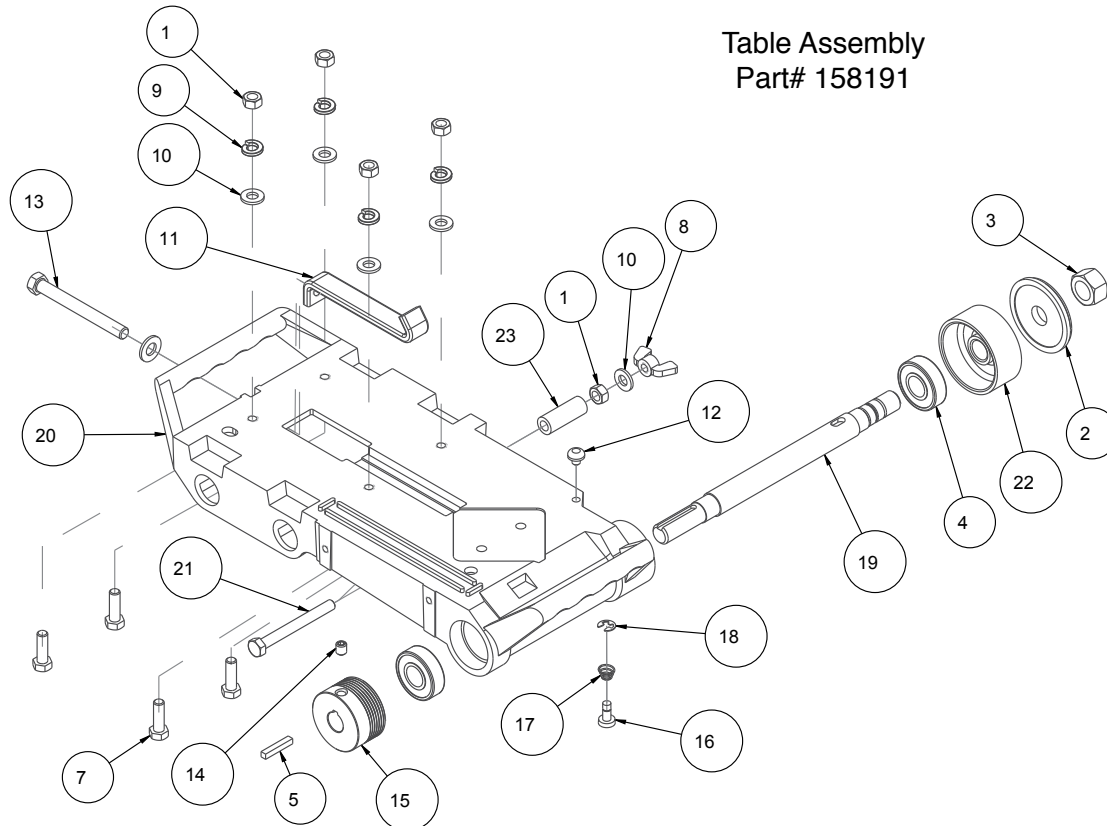

ITEM #	DESCRIPTION	PART #	QTY.
1	NUT, HEX, 5/16 - 18	101196	5
2	FLANGE, OUTER, 2 - 3/8	135830	1
3	NUT, HEX, 5/8-18	135848	1
4	BEARING, BALL, 17X40X12MM	137711	2
5	KEY, 3/16 SQ X 1-1/8	150344	1
6	WASHER, FLAT, SAE, 3/8	150923	1
7	SCREW, HEX HD, 5/16-18X1	151743	4
8	NUT, WING, NYLK, 5/16-18	151746	1
9	WASHER, LOCK, SPLIT, 5/16	151747	4
10	WASHER, FLAT, SAE, 5/16	151754	5
11	STRAP, 1 INCH, MOTOR ADJ.	152673	1
12	BUMPER, RUBBER, 1/2 DIA	152674	1
13	BOLT, 3/8-16 X 3-1/2 HEX HEAD TAP	153147	1
14	SCREW, 5/16-18 X 3/8 SOCKET HEAD SET	157083	1
15	PULLEY, 6J19 X 5/8 BORE	158199	1
16	BUTTON, SHAFT LOCK	158200	1
17	SPRING, BLADE SHAFT LOCK	158201	1
18	RING, 1/4 E-STYLE RETAINING	158202	1
19	SHAFT, BLADE	158222	1
20	CASTING, 10" CTTG HEAD - COMP	158224	1
21	SCREW, HEX HD, TAP, 5/16-18X3	162473	1
22	FLANGE, Ø 2-3/8 INNER	162758	1
23	SPACER, 9/16X5/16X1.5, PLAS	170824	1

THEORY OF DIAMOND BLADES

Diamond blades do not really cut; they grind the material through friction. Diamond crystals, often visible at the leading edge and sides of the rim/segment, remove material by scratching out particles of hard, dense materials, or by knocking out larger particles of loosely bonded abrasive material. This process eventually cracks or fractures the diamond particle, breaking it down into smaller pieces. As a result, a diamond blade for cutting soft, abrasive material must have a hard metal matrix composition to resist this erosion long enough for the exposed diamonds to be properly utilized. Conversely, a blade for cutting a hard, non-abrasive material must have a soft bond to ensure that it will erode and expose the diamonds embedded in the matrix. These simple principles are the foundation of “controlled bond erosion”.



Types of Cutting

There are two basic types of cutting-Dry or Wet. The choice of which type of blade to use depends on

- The requirements of the job
- The machine/tool utilizing the diamond blade
- The preference of the operator

In the case of DRY cutting, the overwhelming popularity and quantity of hand-held saws and the flexible nature of MK Diamond blades to professionally handle most ceramic, masonry, stone and concrete materials, make the DRY cutting blade a very attractive tool. When using a DRY blade, the user must be aware of distinct operating practices to ensure optimum performance. DRY cutting blades require sufficient airflow about the blade to prevent overheating of the steel core. This is best accomplished by shallow, intermittent cuts of the material with periods of “free-spinning” (for several seconds) between each cut, to maximize the cooling process.

For WET cutting applications, MK has the exact blade to compliment both the material to be cut and the wet cutting machine to be used. During cutting operations, liberal amounts of water act as a coolant to support the cutting effectiveness and longevity of the WET blade. Additionally, using water adds to the overall safety of cutting operations by keeping the dust signature down.

Know All You Can About the Material You Wish to Cut

ITEM	NUMBER	DESCRIPTION	
1.	137166	MK-200. 10" X 5/8" ARBOR Premium grade Diamond Blade for smooth, chip-free cutting on tile.	
2.	128074	MK-215, 10" X 5/8" ARBOR Supreme grade diamond blade for hard materials	
3.	153252	MK-315, 10" X 5/8" ARBOR Supreme super hi-rim diamond blade	
4.	134577-MK	DUAL 45° FLAT ANGLE GUIDE	
5.	153201-MK	45° MITER	
6.	134569-MK	90° PROTRACTOR	
7.	152792	DRESSING STONE	
8.	152610	GROUND FAULT CIRCUIT INTERRUPTER	
9.	168244	SAW STAND	

NOTES

ORDERING INFORMATION

You may order MK Diamond products through your local MK Diamond distributor or, you may order direct from MK Diamond.

When ordering direct from MK Diamond, please have the following information ready before calling:

- The Model Number of the saw
- The Serial Number of the saw
- Where the saw was purchased and when
- The Part Number for the part(s) being ordered
- The Part Description for the part(s) being ordered

NOTE: There is a \$25.00 minimum order when ordering direct from MK Diamond. A \$6.00 charge will be added to orders having a net billing value under \$50.00. All purchases must be made using VISA, MasterCard or American Express.

All parts may be ordered by calling toll free to – 800 421-5830 or 310 539-5221 and asking for Customer Service. For technical questions, call – 800 474-5594.

RETURN MATERIALS POLICY

To expedite the service relative to the return of a product purchased through MK Diamond, please observe the following:

NOTE: When returning all items, they must have been purchased within the previous twelve (12) months.

- Have the Model Number of the saw
- Have the Serial Number of the saw
- Have the location of where the saw was purchased
- Have the date when the saw was purchased
- Contact Customer Service for approval to return the item(s)
- Obtain a Returned Goods Number (RGA) authorizing the return
- Follow the packaging instructions in the following section
- Ensure your item(s) are prepaid to the destination

For returned items, call toll free to – 800 421-5830 or 310 539-5221 and ask for Customer Service. For technical questions, call – 800 474-5594 or 310 257-2845.

PACKAGING INSTRUCTIONS

- Remove the Cutting Head and Support Angle Assembly
- Dry the saw before shipping
- When packing, include the following: Saw, Diamond Blade, Blade Guard and Support Angle Assembly and Adjustable Cutting Guide (Other Accessories are not required)
- Package the unit in its original container or one of comparable size (do not ship the unit partially exposed)
- Ensure all parts are secured in the packaging to prevent moving

AUTHORIZED SERVICE CENTERS

For quicker repair time, you may contact MK Diamond Customer Service, toll free, at 800 421-5830 or 310 539-5221 for the Authorized Service Center closest to you or visit our web site at www.mkdiamond.com. For technical questions, call – 800 474-5594.

CONTACT:

Please contact MK Diamond Products, Inc. Customer Service Department with any questions you might have regarding distributors, parts or service.

Telephone: **(800) 421-5830**

Fax: **(310) 539-5158**

E-mail: **Customer_Service@MKDiamond.com**

Customer Service Hours: **Monday through Friday, 6AM-4PM PST**

MK Diamond Products, Inc.

1315 Storm Parkway

Torrance, CA 90501

MK DIAMOND PRODUCTS, INC. LIMITED WARRANTY

MK DIAMOND PRODUCTS, INC. will guarantee every machine they build, to be free from defects in material and workmanship for (1) one year from date of purchase. The obligation of MK DIAMOND PRODUCTS, INC. under this warranty is limited to the repair or replacement of any parts which, under normal use, prove to be defective in material or workmanship. The parts involved or the unit in question should be returned to MK DIAMOND PRODUCTS, INC. or to a point designated by us, transportation prepaid.

This warranty does not obligate us to bear the cost of labor or transportation charges in connection with replacement or repair of defective parts. Likewise, it shall NOT apply to any unit which has been subjected to misuse, neglect or accident. This warranty does NOT apply to any machine which has been repaired or altered outside our factory.

This warranty does NOT obligate MK DIAMOND PRODUCTS, INC., with respect to items not of our manufacture, such as engines, motors, hydraulics, etc., which are subject to their own guarantees and warranties.

We shall in no event be liable for consequential damages or contingent liabilities arising out of failure of any equipment or parts to operate properly.

© COPYRIGHT 2014, MK DIAMOND PRODUCTS, INC. ALL RIGHTS RESERVED.

The MK Diamond logo is a registered trademark of MK Diamond Products, Inc. and may not be used, reproduced, or altered without written permission. All other trademarks are the property of their respective owners and used with permission.

MK Diamond may have patents, patent applications, trade marks, copyrights of other intellectual property right covering this product in this document.

This manual MUST accompany the equipment at all times. This manual is considered a permanent part of the equipment and should remain with the unit if resold.

The information and specifications included in this publication were in effect at the time of approval for printing.

MK-101-24 TILE SAW
OWNERS MANUAL & OPERATING INSTRUCTION



MK Diamond Products, Inc.

MK Diamond Products, Inc.
1315 Storm Parkway
Torrance, CA 90501

Toll-Free: (800) 421-5830
Phone: (310) 539-5221
Fax: (310) 539-5158
www.mkdiamond.com