

**MK-1600**  
**OWNER'S MANUAL &**  
**OPERATING INSTRUCTIONS**

**Gas Powered**  
**Concrete Saw**



Revision 202	03.2013
Manual Part# 157841	

**Caution:** Read all safety and operating instructions before using this equipment. This owner's manual **MUST** accompany the equipment at all times.

## INTRODUCTION

Congratulations on your purchase of a MK-1600 Concrete Saw. We are certain that you will be pleased with your purchase. MK Diamond takes pride in producing the finest construction power tools and diamond blades in the industry.

Operated correctly, your MK-1600 Concrete Saw should provide you with years of service. In order to help you, we have included this manual. This owners manual contains information necessary to operate and maintain your MK-1600 Concrete Saw safely and correctly. Please take the time to familiarize yourself with the MK-1600 Concrete Saw by reading and reviewing this manual.

Read and follow all safety, operating and maintenance instructions.

If you should have questions concerning your MK-1600 Concrete Saw, please feel free to call our friendly customer service department at: 800 421-5830

Regards,

MK Diamond

### NOTE THIS INFORMATION FOR FUTURE USE:

<b>MODEL NUMBER:</b>	
<b>SERIAL NUMBER:</b>	
<b>PURCHASE PLACE:</b>	
<b>PURCHASE DATE:</b>	

**NOTE:** For your (1) one year warranty to be effective, complete the warranty card (including the Serial Number) and mail it in as soon as possible.

# TABLE OF CONTENTS

## **SAFETY**

Safety Messages	4
Damage Prevention Message	4
General Safety Precautions and Hazard Symbols	5
California Proposition 65 Message	8
Prestart Safety	9
Safety Label Locations	10
Product Specifications	11

## **UNPACKING, TRANSPORT and ASSEMBLY**

Unpacking	12
Contents	12
Transport	13
Assembly	14-15

## **STARTUP, OPERATION and SHUTDOWN**

Startup	16-17
Operation	18-20
Shutdown	21
Cleanup	21

## **MAINTENANCE AND TROUBLESHOOTING**

Maintenance	22-30
Troubleshooting	31

## **EXPLODED VIEW & PARTS LIST**

Exploded View	34-36
Parts List	37-39

## **THEORY**

Theory Of Diamond Blades	40
--------------------------	----

## **ACCESSORIES ORDERING and RETURN INSTRUCTIONS**

Accessories	41
Ordering Information	42
Return Material Policy	42
Packaging Instructions	42
Authorized Service Centers	42
Warranty	43

Safety precautions should be followed at all times when operating this equipment. Failure to read and understand the Safety Precaution and Operating Instructions could result in injury to yourself and others.

This Operation Manual has been developed to provide complete instructions for the safe and efficient operation of the MK-1600 Concrete Saw.

Before using this saw, ensure that the person operating the equipment has read and understands all instructions in this manual.

Descriptions, illustrations, and photos are as accurate as possible at the time of publication. Photos may include optional equipment or accessories and may not show all models covered by this manual.

### **SAFETY MESSAGE / ALERT SYMBOLS**

---

A safety message alerts you to potential hazards that could hurt you or others. Each safety message is preceded by a safety alert symbol (  ) and one of three words: **DANGER**, **WARNING**, or **CAUTION**.

#### **DANGER**

You **WILL** be **KILLED** or **SERIOUSLY INJURED** if you do not follow directions.

#### **WARNING**

You **CAN** be **KILLED** or **SERIOUSLY INJURED** if you do not follow directions.

#### **CAUTION**

You **CAN** be **INJURED** if you do not follow directions. It may also be used to alert against unsafe practices.

Each message tells you what the hazard is, what can happen, and what you can do to avoid or reduce injury. Other important messages are preceded by the word **NOTICE**.

#### **NOTICE**

You can cause **PROPERTY DAMAGE** to your machine if you don't follow directions.

The safety labels should be periodically inspected and cleaned by the user to maintain good legibility at a safe viewing distance. If the label is worn, damaged or illegible, it should be replaced. Contact MK Diamond or your dealer for replacement.

### **DAMAGE PREVENTION AND INFORMATION MESSAGES**

---

A Damage Prevention Message is to inform the user of important information and/or instructions that could lead to equipment or other property damage if not followed. Information messages convey information that pertains to the equipment being used. Each message will be preceded by the word **NOTE**, as in the example below.

**NOTE:** Equipment and/or property damage may result if these instructions are not followed.

## GENERAL SAFETY PRECAUTIONS AND HAZARD SYMBOLS

---

### SAFETY PRECAUTIONS

In order to prevent injury, the following safety precautions and symbols should be followed at all times!

### GENERAL SAFETY

---



**DO NOT** operate or service this equipment before reading this entire manual.

This equipment should not be operated by persons under 18 years of age.

**NEVER** operate this equipment when not feeling well due to fatigue, illness or taking medicine.

**NEVER** operate this equipment under the influence of drugs or alcohol.

Whenever necessary, replace nameplate, operation and safety decals when they become difficult to read.

**ALWAYS** store equipment properly when it is not being used. Equipment should be stored in a clean, dry location out of the reach of children.

### KEEP GUARDS IN PLACE



In order to prevent injury, keep guards in place and in working order at all times.

### EXPLOSIVE FUEL!



Gasoline is extremely flammable, its vapors can explode if ignited; store only in approved containers, in well-ventilated, unoccupied buildings and away from sparks or flames. Do not fill the fuel tank while the engine is running or hot. Spilled fuel could ignite if it contacts hot parts or sparks from ignition. Do not start the engine near spilled fuel. Never use gasoline as a cleaning agent. Never operate the machine in an explosive atmosphere.

### LETHAL EXHAUST GASES



Engine exhaust gasses contain poisonous carbon monoxide, an odorless colorless gas that can cause death if inhaled. Avoid inhaling exhaust fumes, and never run the engine in a closed building or confined area.

### ENGINE OVER-SPEED



Never tamper with the governor components or settings to increase the maximum speed of the machine. Severe personal injury and/or equipment damage could result if the equipment is operated speeds above design maximum.

### ACCIDENTAL STARTS



Before starting the engine, be sure the ON/OFF switch is in the “OFF” position to prevent accidental starting. Place the ON/OFF switch in the OFF position before performing any service operation.

### ROTATING OR MOVING PARTS



Keep hands, feet, hair, and clothing away from all moving parts to prevent injury. Never operate a power tool with shrouds or guards removed.

### HOT PARTS



Engine components can become extremely hot from operation. To prevent severe burns, do not touch these areas while the engine is running, or immediately after it is turned off. Never operate the engine with heat shields removed.

### ALWAYS USE SAFETY GLASSES



Safety glasses should always be worn when working around power tools. Everyday eye-glasses only have impact resistant lenses and may not prevent eye injury; they are NOT safety glasses.

### ALWAYS USE RESPIRATORY PROTECTION



Exhaust gases may be harmful if inhaled. Do not operate gas-powered equipment in enclosed spaces. Respiratory protection should be worn when operating gas powered equipment.

### ALWAYS USE HEARING PROTECTION



To reduce the possibility of hearing loss, always use hearing protection when operating equipment.

### REMOVE ADJUSTING KEYS AND WRENCHES

Form a habit of checking to see that keys and adjusting wrenches are removed from the power tool before it is turned on.

### KEEP WORK AREA CLEAN

Cluttered work areas and benches invite accidents.

### DO NOT USE IN DANGEROUS ENVIRONMENTS

Do not operate equipment in dangerous environments. Always keep the work area well lighted.

### KEEP CHILDREN AWAY

All visitors and children should be kept a safe distance from work area.

### MAKE WORKSHOP KID PROOF

Make the workshops kid proof by using padlocks, master switches or by removing starter keys.

**DO NOT FORCE THE TOOL**

A power tool will do a job better and safer operating at the rate for which it was designed.

**USE THE RIGHT TOOL**

Do not force a tool or an attachment, to do a job that it was not designed to do.

**WEAR PROPER APPAREL**

Do not wear loose clothing, gloves, neckties, rings, bracelets, or other jewelry that may be caught in moving parts. Nonslip footwear is recommended. Wear protective hair covering to contain long hair.

**SECURE WORK**

Clamps or a vise should be used to hold work whenever practical. Keeping your hands free to operate a power tool is safer.

**DO NOT OVERREACH**

Keep proper footing and balance at all times by not overreaching.

**MAINTAIN TOOLS WITH CARE**

Keep tools sharp and clean for the best and safest performance. Always follow maintenance instructions for lubricating and when changing accessories.

**SHUTDOWN TOOL**

The saw should always be shutdown before servicing or when changing accessories such as blades, bits, cutters, etc...

**USE RECOMMENDED ACCESSORIES**

Consult the owner's manual for recommended accessories. Using improper accessories may increase the risk of personal or by-stander injury.

**NEVER STAND ON THE TOOL**

Serious injury could occur if a power tool is tipped, or if a cutting tool is unintentionally contacted.

**NEVER LEAVE TOOL RUNNING UNATTENDED – TURN POWER OFF**

Do not leave a tool until it comes to a complete stop. Always turn a power tool OFF when leaving the work area, or, when a cut is finished.

**CHECK FOR DAMAGED PARTS**

Before using a power tool, check for damaged parts. A guard or any other part that is damaged should be carefully checked to determine it would operate properly and perform its intended function. Always check moving parts for proper alignment or binding. Check for broken parts, mountings and all other conditions that may affect the operation of the power tool. A guard or any damaged part should be properly repaired or replaced.

**DIRECTION OF FEED**

Always feed work into a blade or cutter against the direction of rotation. A blade or cutter should always be installed such that rotation is in the direction of the arrow imprinted on the side of the blade or cutter.

**SILICA DUST WARNING**

---

Grinding/cutting/drilling of masonry, concrete, metal and other materials with silica in their composition may give off dust or mists containing crystalline silica. Silica is a basic component of sand, quartz, brick clay, granite and numerous other minerals and rocks. Repeated and/or substantial inhalation of airborne crystalline silica can cause serious or fatal respiratory diseases, including silicosis. In addition, California and some other authorities have listed respirable crystalline silica as a substance known to cause cancer. When cutting such materials, always follow respiratory precautions.

**CALIFORNIA PROPOSITION 65 MESSAGE**

---

Some dust created by power sanding, sawing, grinding, drilling, and other construction activities contain chemicals known (to the State of California) to cause cancer, birth defects or other reproductive harm. Some examples of these chemicals are:

- Lead, from lead-based paints
- Crystalline silica, from bricks and cement and other masonry products
- Arsenic and chromium, from chemically treated lumber

For further information, consult the following sources:

<http://www.osha.gov/dsg/topics/silicacrystalline/index.html>

<http://www.cdc.gov/niosh/consilic.html>

<http://oehha.ca.gov/prop65/law/P65law72003.html>

<http://www.dir.ca.gov/Title8/sub4.html>

Your risk from these exposures varies depending on how often you do this type of work. To reduce your exposure to these chemicals, work in a well-ventilated area, and work with approved safety equipment, such as those dust masks that are specially designed to filter out microscopic particles.



Before starting the machine, **ALWAYS** check that all guards are in position and correctly fitted. Check the machine for loose bolts before starting.

Keep area around the machine clear of obstructions which could cause persons to fall onto moving parts. **ALWAYS** ensure that the machine is on level ground before using. Know how to stop the machine quickly in case of emergency. **NEVER** try to stop a moving blade with your hands.

- **NEVER** disconnect any “emergency or safety devices”. These devices are intended for operator safety. Disconnection of these devices can cause severe injury, bodily harm or even death! Disconnection of any of these devices will void all warranties.
- Unauthorized equipment modifications will void all warranties. Manufacturer does not assume responsibility for any accident due to equipment modifications.
- **NEVER** use accessories or attachments, which are not recommended by MK Diamond for this equipment. Damage to the equipment and/or injury to user may result.

**WARNING**

**DO NOT** use woodcutting, or carbide blades on this machine! Use **ONLY** Diamond blades on machine.

**OPERATION & SAFETY DECALS**

The MK-1600 Concrete Saw is equipped with a number of safety decals. These decals are provided for operator safety and maintenance information. Should any of these operation or safety decals become unreadable, replacements can be obtained by calling (800) 262-1575.

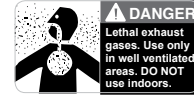
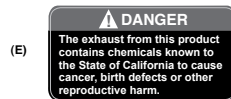
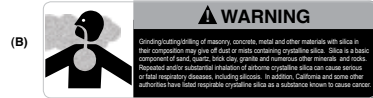
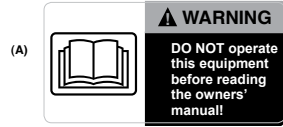
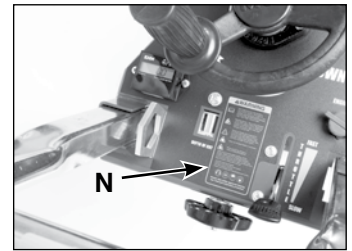
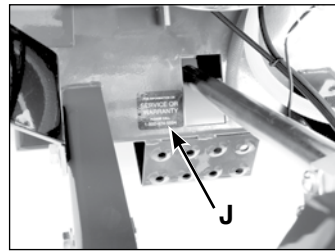
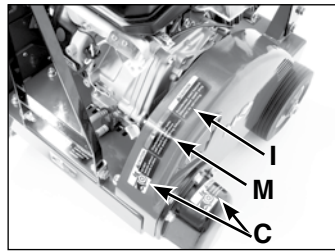
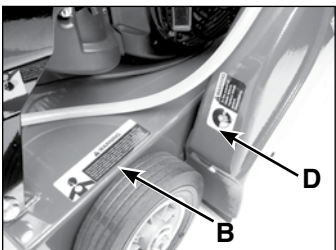
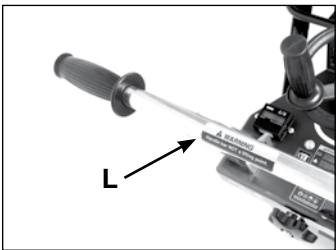
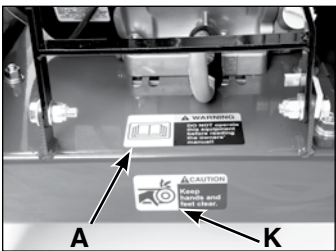
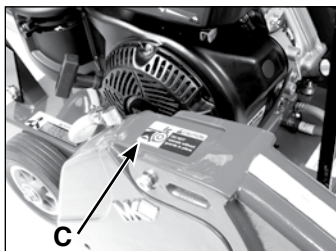
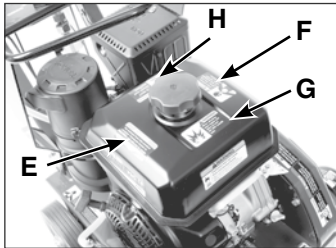

Concrete Saw Warning Label Sheet Part# 166009



Location	Description
A	Frame Read Manual
B	Frame Proposition 65, Dust Warning
C	Shaft Cover & Belt Guard Guards in Place
D	Blade Guard Replace Blade Guard
E	Gas Tank/Top Exhaust/Cancer
F	Gas Tank/Top Lethal Exhaust
G	Gas Tank/Top Refueling
H	Gas Tank Hot Surface
I	Blade Guard Accidental Start
J	Frame/Back Service
K	Frame/Front Hand & Feet Clear
L	Handle Lifting Point
M	Belt Guard Overtensioning Belts
N	Console Machinery Hazard

## PRODUCT SPECIFICATIONS

The MK-1600 is a versatile gas powered Concrete Saw. Operated and used according to this manual, the MK-1600 will provide years of dependable service.

### General Description

The MK-1600 is engineered as a portable concrete saw powered by a Honda, Vanguard or Kohler gas engine. The saw is capable of 6-5/8" depth of cut with an 18" blade.

### Motor and Weight Specifications

Motor and Weight specifications for the MK-1600 are listed below.

General Specifications	
Arbor Size	1" (25mm)
Blade Capacity	18" (45mm)
Blade RPM	2,700
Depth of Cut	6-5/8" (168mm)
L x W x H (inches)	42" x 25" x 39"
L x W x H (mm)	1067 x 635 x 991

Model	MK-1609H Standard	MK-1613H Standard	MK-1613S Standard	MK-1613V Standard
Engine	Honda (Gas)	Honda (Gas)	Subaru (Gas)	Vanguard (Gas)
Power	GX240 Cyclone	GX390 Cyclone	EH41	V-Twin
Weight	210 lbs. (95 kgs)	223 lbs. (101 kgs)	223 lbs. (101 kgs)	233 lbs. (106 kgs)
Part #	157867	160832	160832-S	169948

Model	MK-1614K Standard	MK-1613S Premium	MK-1614K Premium	MK-1613H Premium
Engine	Kohler (Gas)	Subaru (Gas)	Kohler (Gas)	Honda (Gas)
Power	CH440	EH41	CH440	GX390 Cyclone
Weight	223 lbs. (101 kgs)	233 lbs. (106 kgs)	233 lbs. (106 kg)	233 lbs. (106 kg)
Part #	157864-K	160772-S	168930	160772

### Blade

The MK-1600 uses a 16 or 18 inch diameter diamond blade.

### Concrete Saw Usage

The MK-1600 is designed to cut various grades of concrete surfaces.

### MK-1600 Series Features

- One-piece box construction chassis made from 3/16" hot-rolled steel
- Powder-coated chassis resists peeling and corrosion
- Cast-aluminum hinged blade guard
- Stainless steel water distribution system supplies water to both sides of blade
- Blade guard mounts on both left- or right-hand side of saw and cuts within 2" of wall or curb
- 1" blade shaft supported by two heavy-duty, self-aligning pillow block bearings
- Depth control assembly engineered for smooth, controlled blade insertion
- Durable 8" x 2-1/4" non-slip rubber wheels with maintenance-free hubs & roller bearings
- Positive-locking depth control mechanism
- Premium Series saws include built-in depth gauge, tach/hour meter, and lifting bail
- One-year limited warranty

**UNPACKING**

Your saw has been shipped from the factory thoroughly inspected. Only minimal assembly and service is required. Check each, item, making certain all items are accounted for and in good visual condition before discarding any packing materials. If there are any missing or damaged parts call MK Diamond Customer Service at 800-421-5830.







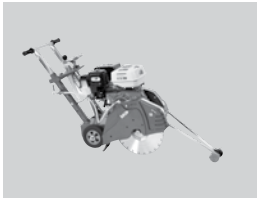

**WARNING** Never start engine until all initial servicing and set up steps are completed according to this operations manual and engine manual. Read and familiarize yourself with all controls and features of the saw before beginning operations.

Remove the saw from the pallet and place it on a flat surface. Two people are required to lift saw.

**CONTENTS**

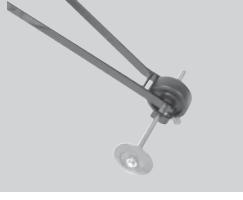
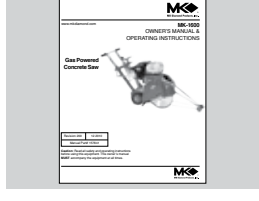
In the containers, you will find one (1) MK-1600 Saw, one (1) Blade Nut Wrench, one (1) Handlebar, two (2) Handlebar Bolts and Washers, one (1) Pointer, one (1) MK-1600 Owner's Manual, one (1) Engine Owners Manual, one (1) Warranty Card.

				
<p>MK-1600 Saw</p>	<p>Blade Nut Wrench</p>	<p>Handlebar</p>	<p>Handlebar Bolts and Washers</p>	<p>Pointer</p>
				
<p>MK-1600 Owner's Manual</p>	<p>Engine Manual</p>	<p>Warranty Card</p>		

## TRANSPORT



- CAUTION**
1. The MK-1600 weighs approximately two hundred and thirty-five (235 pounds), use care when transporting.
  2. Two people are required to lift and transport the MK-1600.
  3. A lifting bail is included on Premium models or available as an option.

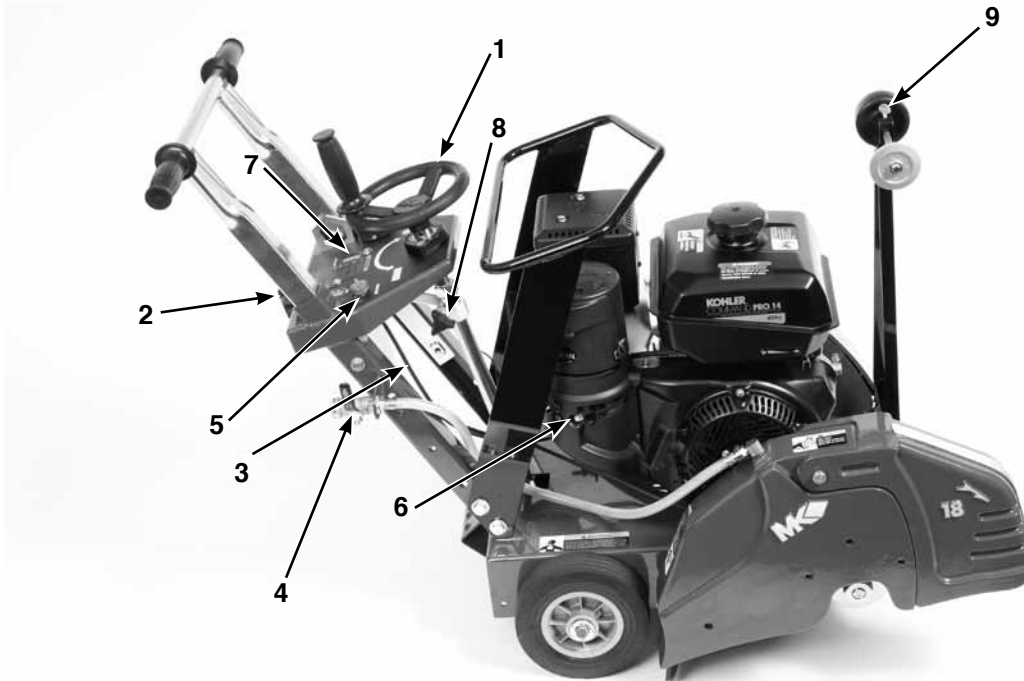

1. The raise lever wheel raises the blade when rotated clockwise, and lowers the blade when rotated counterclockwise.
2. The raise/low wheel lock is engaged when the knob is tightened.
3. The throttle control increases engine rpm from slow (idle) at the bottom, to fast (full rpm) at the top.
4. The water control lever is off in the vertical position and fully on in the horizontal position. It may be placed at in between settings to regulate the water flow.
5. The engine master switch is located on the console for quick engine shut-off.
6. The choke is located on the engine, by the pull starter, for convenient cold starting.
7. Depth control indicator should be adjusted to zero when setting up saw. (Premium models only.)
8. Depth control clamp must be adjusted for desired depth of cut.
9. The pointer is set in line at the factory but should be checked for proper alignment with the blade after every use.

Follow the assembly instructions to prepare your saw for operation.

### Handlebar Assembly



(A)

Locate the threaded holes on both sides of the handlebar.

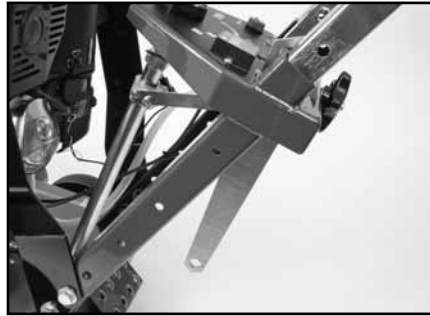

(B)

Align the handlebar with the holes on both sides of the frame at the desired height.

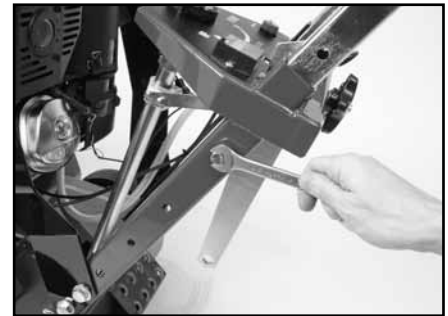

(C)

Install one Washer onto each bolt. Install bolt through the Handlebar and into the holes and tighten.

### Filling Oil Reservoir

**NOTE:** The engine is shipped with no oil in the crankcase. Refer to the engine manual for details on the type and amount of oil required.

To fill the crankcase with oil, place the engine level. In order for this to be accomplished the blade must not be installed, and the depth adjustment must be down (until the engine is level).



(A)

Verify the Oil Drain Cap is installed onto the Oil Drain Line and is tight. Refer to Engine Manual for details.



## Diamond Blade Installation

- NOTE:**
1. When installing the blade retaining-bolt, ensure the threads of the bolt are aligned with the threads of the drive shaft so as not to “cross-thread” the bolt.
  2. When installing the blade ensure that the blade shaft and flanges are free from dirt and all foreign material before mounting blade on the blade shaft. Tightening a blade against an uneven surface can cause fracture or cause the blade to run out of alignment.
  3. Blade shaft threads are left-handed on the right side of the saw and right-hand on the left of the saw.

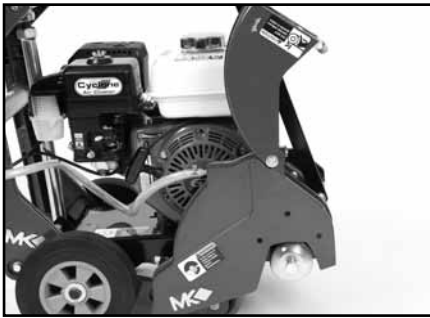

(A)

Open the Blade Guard Cover. Locate the Blade Shaft Nut and the Outer Flange.

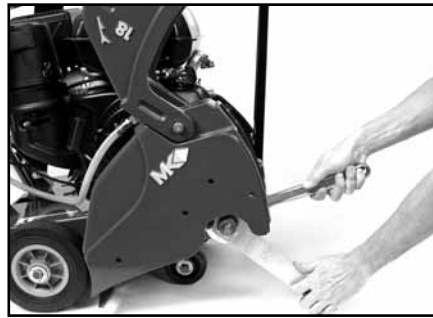

(B)

Loosen the Blade Shaft Nut while holding the Shaft Wrench steady.



(C)

Remove the Blade Nut and Outer Flange.

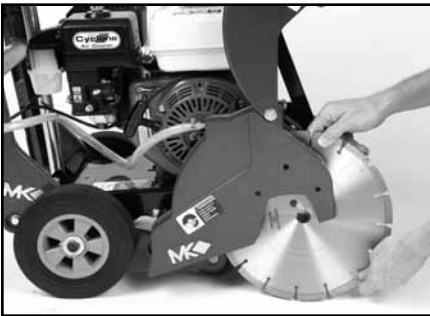

(D)

Install the Diamond Blade onto the Blade Shaft. Ensure directional arrow on the blade indicates proper rotational direction.



(E)

Install the Outer Flange. Verify the drive pin is seated; it must project through the hole in the blade and into the flange.

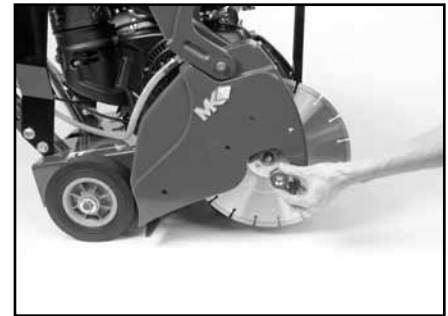

(F)

Install the Blade Shaft Nut.



(G)

Tighten Blade Shaft Nut holding the Blade Shaft steady. Lower and close Blade Guard.



### WARNING

Do not operate the saw without the proper Blade Guard covering. Ensure that the blade exposure does not exceed 180 degrees during operation.

## Filling Fuel Tank



- WARNING**
1. Gasoline is highly flammable and explosive. You can be burned or seriously injured when handling fuel.
  2. To fuel, stop engine if running, and allow it to cool.
  3. Refuel in a well-ventilated area.
  4. Keep gasoline away from appliance pilot lights, barbeques, electric appliances, power tools, etc.
  5. Wipe up spills immediately. Do not start engine until spill is dry.

- NOTE:**
1. Fuel can damage paint and plastic. Be careful not to spill fuel when filling the fuel tank. Damage caused by spilled fuel IS NOT covered under the warranty.
  2. DO NOT use stale or contaminated gasoline, or an oil/gasoline mixture.



(A)

Remove the Fuel Cap. Refer to Engine Manual for details.

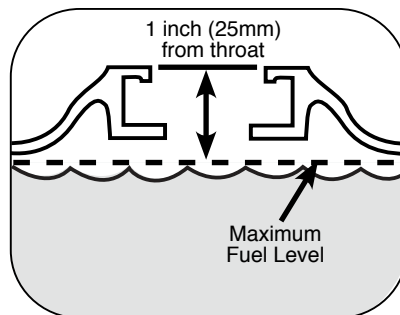

(B)

Ensure fuel level is 1" below the throat of the Fuel Tank.

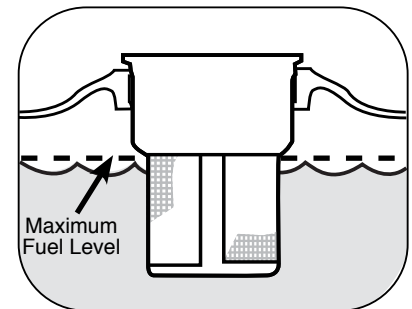

(C)

Ensure fuel level is below the top of the strainer filter.

## Pre-Start Inspection

The pre-start inspection should be performed before beginning any job. If Diamond Blade is worn, replace the blade before starting work.

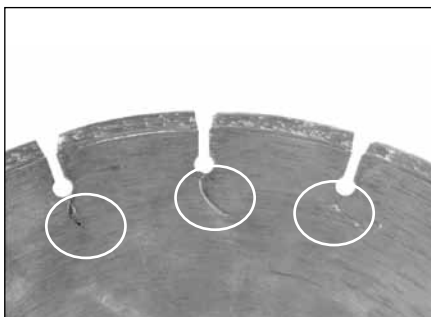

(A)

Inspect Blade for damage for cracks. Verify the Blade is correct for the material being cut.



(B)

Inspect Engine for leaks.



(C)

Inspect the saw for general damage and/or loose hardware.



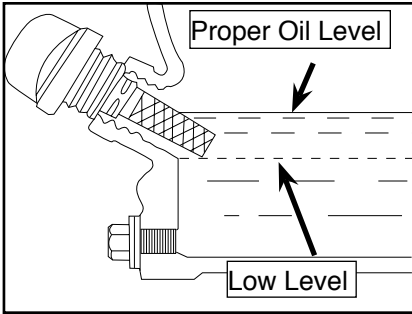

(D)

Check for proper oil level. Refer to Engine Manual for details.

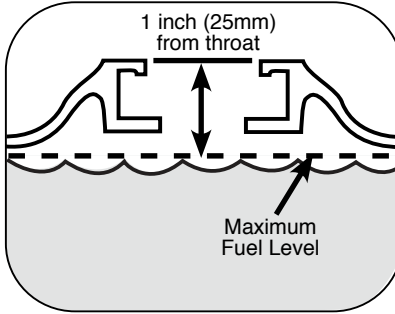

(E)

Ensure fuel level is 1" below the throat of the Fuel Tank.

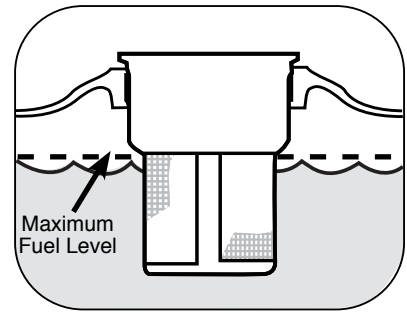

(F)

Ensure fuel level is below the top of the strainer filter.



(G)

Check the Air Filter for cleanliness. Refer to Engine Manual for details.

### Engine Start



**WARNING**

1. Carbon monoxide gas is toxic, breathing it can cause unconsciousness and/or death.
2. Avoid any areas or actions that expose you to carbon monoxide.



(A)

Use the Depth Control Wheel to raise the Blade clear of the floor. Refer to Engine Manual for starting procedure.

**Front Pointer Alignment**

The Front Pointer is set in line at the factory. However, the pointer should be checked for proper alignment with the blade after every use.

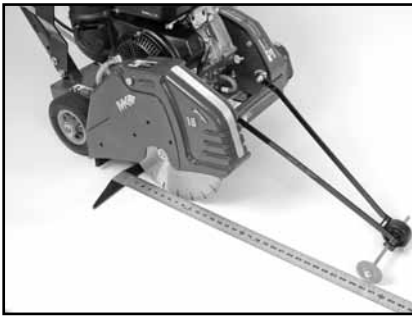

(A)

Using a straight edge, carefully mark a line 12 feet long on a smooth level concrete surface. Place Saw parallel to line; lower Blade and center it over the line.



(B)

With the Blade centered over the line and the Saw Frame parallel to the line, lower the front Pointer assembly and position the pointer over the line.

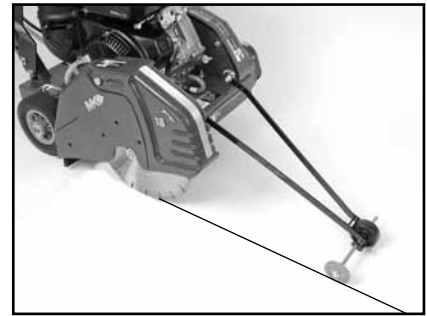

(C)

Adjust the Pointer in or out if the orange wheel is off the line by loosening the thumbscrew on the end of pointer. Align orange wheel with line and tighten thumbscrew.

**Adjusting Depth of Cut Gauge**



(A)

Loosen Depth Lock Knob.



(B)

Turn Crank Wheel until Blade touches the ground.



(C)

Loosen Depth Indicator Knob and slide the Depth Control Clamp until the Depth of Cut Indicator reads zero.



(D)

Tighten Depth Indicator Knob.



(E)

Tighten Depth Lock Knob.

## Standard Operation

The MK-1600 is intended for industrial applications and operated by experienced professionals. The operator must be aware of the machine's capabilities and limitations. It is the operators responsibility to use this machine under safe working conditions and conform with federal, state and local codes or regulations pertaining to safety, air, pollution, noise etc...



### CAUTION

Prior to operation of this machine the operator must determine the existence and location of any subsurface features that may be hazardous or could damage the equipment, (i.e. electric cable, natural gas line etc...)



(A)

Use the Depth Control Wheel to raise the blade clear of the floor.

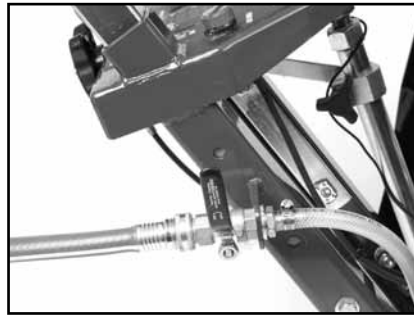

(B)

Attach the cooling supply hose to the Cooling Inlet, if wet cutting.

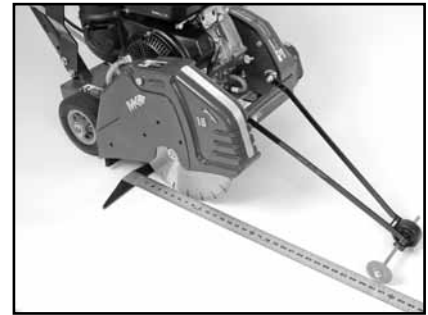

(C)

Lower the Pointer. Using a Straight-edge, align the Pointer to the Blade see "Front Pointer Alignment."

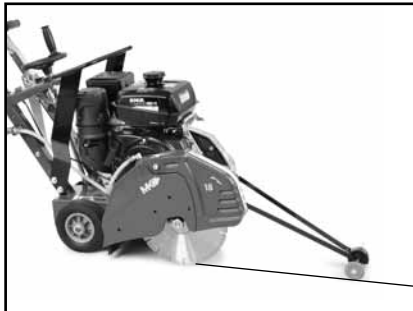

(D)

Layout and mark the area to be cut using a chalk-line. Align Pointer and Blade to chalk-line.

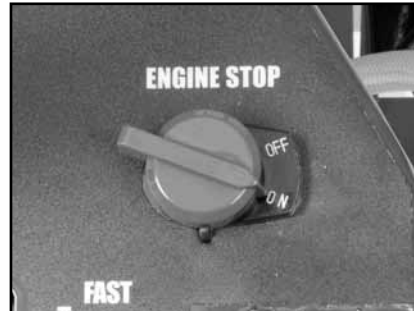

(E)

Place Engine Master Switch in the "ON" Position.



(F)

Start the Saw using the Engine Start procedure in the engine manual.



(G)

With the engine running adjust the throttle approximately half-way.



(H)

For Wet Cutting, open Cooling Supply Valve. Verify proper cooling flow and adjust the water flow on the Blade to a desired amount.



(I)

Move the throttle all the way forward to "Fast" position.

**NOTE:** Perform the cut using only enough pressure to follow the original marked line. The saw has a natural tendency to pull towards the side on which the blade is mounted. To assure straight line cutting, apply pressure to the appropriate handle. If excessive pressure is required reduce the forward speed of the saw. Driving the saw too fast while cutting may cause the front wheels to lift causing the blade to cut at uneven depths. Do not attempt to steer the saw. Sudden and severe corrections can cause the blade to be damaged or broken.



(J)

Slowly lower the Blade until the desired level is reached and begin the cut.



(K)

When the cut is complete, raise the Blade completely out of the cut by turning Depth Control Wheel counter-clockwise.



(L)

Close Cooling Supply Valve.



(M)

Move the Throttle Lever to lower blade speed.

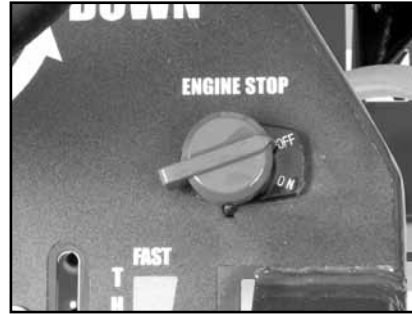

(N)

Place Engine Master Switch in the OFF position. Place Fuel Valve in the OFF position. Refer to Engine Manual.

## Dry Cutting

- NOTE:**
1. Ensure the blade you are using is clearly marked for dry cutting.
  2. Check the condition of the air filter at least every four hours of operation. Refer to Engine Manual for details.

Airflow helps to cool the blade during dry cutting. Cutting too deep with one pass, or exerting excessive forward or side pressure can be dangerous and cause damage. Step cut in increments of 2 inches or less, for best results. Thinner blades are especially advantageous when cutting dry.



## Emergency Engine Shutdown

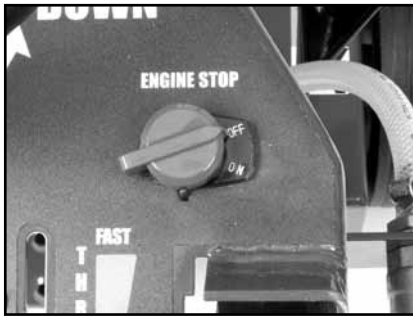

(A)

Place Engine Master Switch in the OFF position.



(B)

Move the Throttle Lever to lower blade speed. Place Fuel Valve in the OFF position.

## Cleanup

**CAUTION**

Engine parts are extremely hot following use, allow engine to cool 1/2-hour before cleaning. Use care during cleanup to avoid injury.

**NOTE:**

1. To extend operating life, the Concrete Saw should be cleaned following every use.
2. Using a garden hose or pressure washer is not advised as it can force water into the air cleaner or muffler opening.
3. Use care when cleaning around electrical components.



(A)

Verify the engine is off and cool before beginning to clean. Clean the saw with soap and water.



(B)

Clean around the Console.



(C)

Clean the Depth Control Screw and lubricate as needed.



(D)

Clean water system outlets, including water tubes in blade guard.



(E)

Clean the remainder of the exterior surface (except the engine).

## Blade Repositioning

**WARNING**

Do not operate saw with any guards removed. Turn master engine switch to off position to avoid accidental starts when removing guards.



(A)  
Remove Diamond Blade.



(B)  
Remove the Cooling Transfer Hose from the Blade Guard by pressing the quick release.

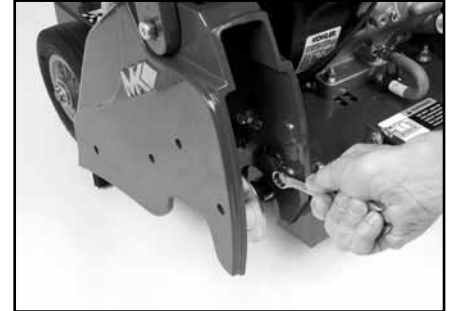

(C)  
Locate the four Blade Guard Retaining Bolts.

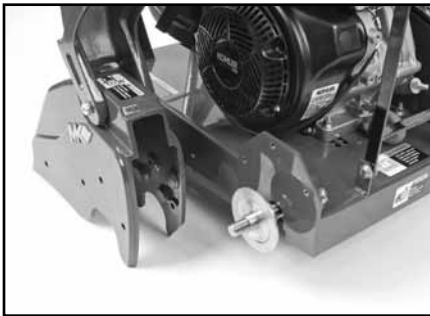

(D)  
Remove the Blade Guard Retaining Bolts and remove the Blade Guard.



(E)  
Locate the Blade Shaft Cover Retaining Bolts.



(F)  
Remove the Blade Shaft Cover Retaining Bolts and the Blade Shaft Cover.

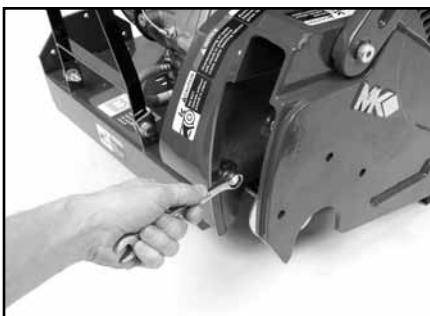

(G)  
Install the Blade Guard on the opposite side of the saw.



(H)  
Install Diamond Blade

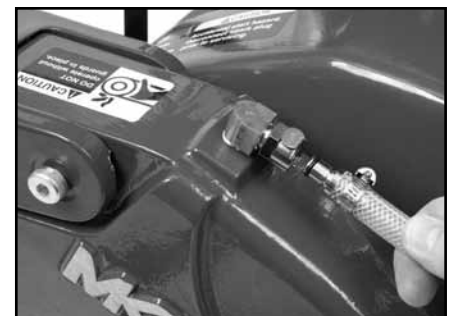

(I)  
Install the Cooling Transfer Hose from the Blade Guard.



(J)  
Install the Blade Shaft Cover.



(K)  
Remove the Pointer.



(L)  
Install the Pointer on the opposite side, next to Blade Guard.



(M)  
Verify the stop Clip is installed as shown.

## MAINTENANCE SAFETY

- Always turn the master engine switch to the off position.
- **NEVER** lubricate components or attempt service on a running machine.
- Keep the machinery in proper running condition.
- Fix damage to the machine immediately and always replace broken parts, or missing decals.

## New Maintenance

Perform the following after initial purchase and operation of the saw.

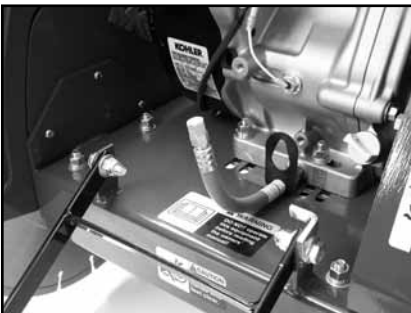

(A)  
Change engine oil after first month or first 20 operating hours (See Engine Manual).

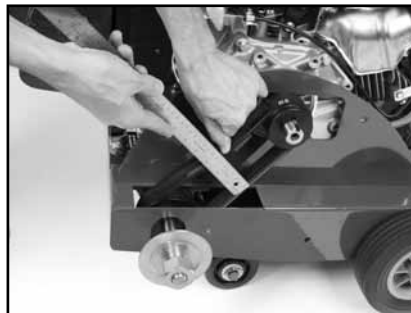

(B)  
Check and adjust tension on all belts following first 48 hours of operation (See Belt section).

**Maintenance Following Use**

The following maintenance should be performed following each use.



(A)  
Shut down the Engine. Let saw cool before proceeding.



(B)  
Check Air Filter  
(See Engine Manual).



(C)  
Lubricate the Grease Fitting.



(D)  
Lubricate the pivot point of the Pointer.

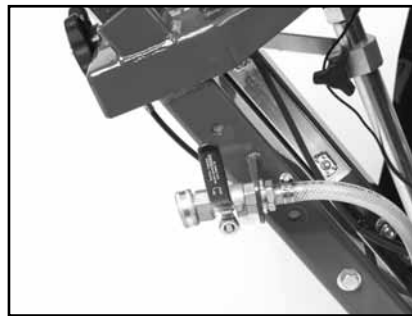

(E)  
Lubricate the Cooling Supply Valve.



(F)  
Verify the tightness of all bolts and screws. Clean the saw (except the engine) with soap and water.

**Weekly (50 hours) and Monthly (200 hours)**

The following should be performed monthly. Items should be lubricated using waterproof grease.



(A)  
Change engine oil every 100 hours. Refer to Engine Manual for details.



(B)  
Lubricate the Depth Control Screw (Monthly).



(C)  
Lubricate the Blade Shaft Bearings (Monthly).





(D)  
Clean engine Air Filter weekly and replace monthly. Refer to Engine Manual for details.



(E)  
Clean Spark Plug Weekly and readjust Spark Plug monthly. Refer to Engine Manual for details.

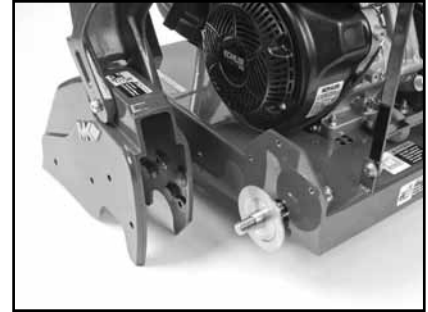

(F)  
Clean and lubricate the Blade Shaft.



(G)  
Clean and lubricate the Blade Retaining Bolt.

**NOTE:** Definitive information on engine maintenance is contained in the engine manual provided separately. Perform all maintenance procedures as recommended by the engine manual.

**500 Hours and 1000 Hour Maintenance**

Perform the following maintenance every 500 hours.



(A)  
Replace Spark Plug. Refer to Engine Manual for details.



(B)  
Have Authorized Repair Shop perform 500-hour maintenance.



(C)  
Have Authorized Repair Shop perform 1000-hour maintenance.

## Yearly and Two-Year Maintenance

Perform the following maintenance every year.

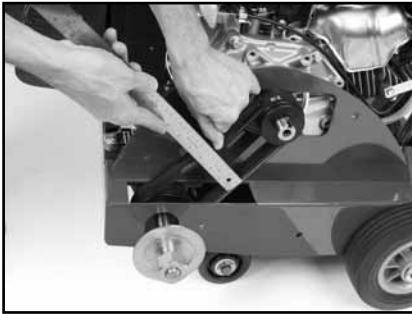

(A)

Inspect belts for proper tension and wear.

## Check Fuel Level

For all Engine related maintenance and troubleshooting refer to the Engine Manual.



### WARNING

1. Gasoline is highly flammable and explosive. You can be burned or seriously injured when handling fuel.
2. To fuel, stop engine if running and allow it to cool.
3. Refuel in a well-ventilated area.
4. Keep gasoline away from appliance pilot lights, barbeques, electric appliances, power tools, etc.
5. Wipe up spills immediately.

### NOTE:

1. Fuel can damage paint and plastic. Be careful not to spill fuel when filling the fuel tank. Damage caused by spilled fuel IS NOT covered under the warranty.
2. DO NOT use stale or contaminated gasoline or an oil/gasoline mixture.



(A)

Remove the Fuel Cap. Refer to Engine Manual for details.

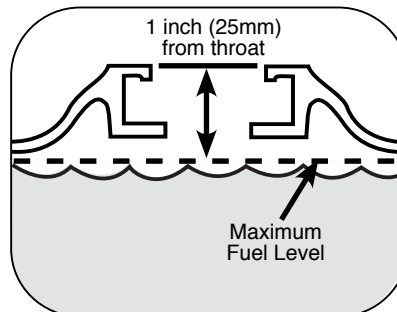

(B)

Ensure fuel level is 1" below the throat of the Fuel Tank.

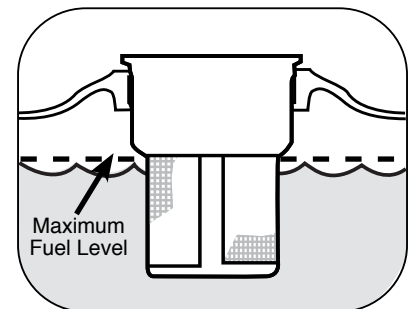

(C)

Ensure fuel level is below the top of the strainer filter.

## Checking Oil Level



(A)

Verify the Engine is upright and level. Refer to Engine Manual for details.

### NOTE:

When installing the Oil Dipstick, ensure the threads are aligned with the threads of the Oil Reservoir so as not to “cross-thread.”

## Engine Maintenance

Engine maintenance and adjustment is necessary to keep the saw in good operation condition. Maintenance operations include oil changes, filter changes, air cleaner, spark plug, fuel filter etc...Perform all maintenance procedures as recommended by the Honda, Kohler or Subaru engine manual provided separately.

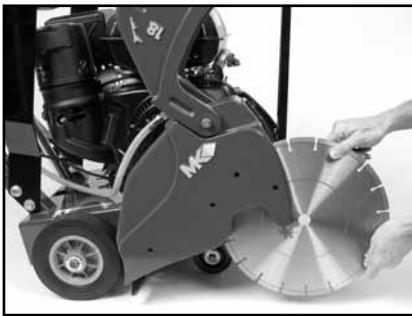

(A)

Remove the Diamond Blade. See Blade removal section.



(B)

Lower the MK-1600 to its lowest position.



(C)

Free the Oil Drain Line. Place a catch basin below the Oil Drain Line. Remove the Drain Cap to drain oil completely. Refer to Engine Manual for details.

## Engine Air Filter Inspection Cleaning and Replacement



(A)

Clean the Air Filter. Refer to Engine Manual for details.

**Spark Plug Adjustments and Replacement**

For all Engine related maintenance and troubleshooting refer to the Engine Manual.

**⚠ CAUTION** DO NOT work around the engine while hot.



(A)

When installing the Spark Plug, ensure the threads are aligned with the threads in the engine so as not to “cross-thread” the plug.

**Diamond Blade Removal**



(A)

Open the Blade Guard Cover.

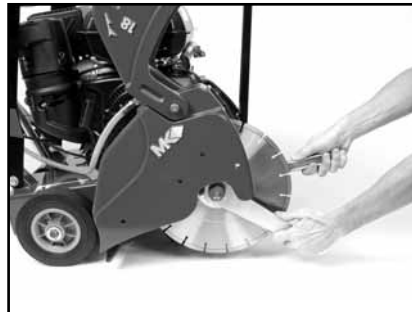

(B)

Remove the Blade Shaft Nut and the Outer Flange.

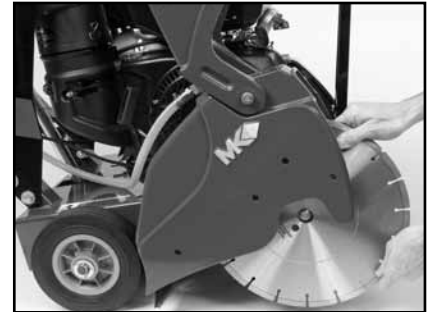

(C)

Remove blade.



(D)

Install the new Blade, Retaining Bolt and Outer Flange.



(E)

Tighten Blade Retaining Bolt while holding the Blade Shaft steady.

## Belt Adjustment and Replacement

In order to ensure the saw operates at peak efficiency, the power transmission belt should be inspected monthly and changed if any signs of damage and/or excessive wear is observed.

- NOTE:**
1. When a new belt is installed, it should be inspected and retensioned after the first forty-eight (48) hours of operation.
  2. Do not over tension belts as damage to belts and bearings may occur. Belts that are too loose may slip, resulting in short life of loss of power to the blade shaft. If any belts are worn or damaged, replace complete set.

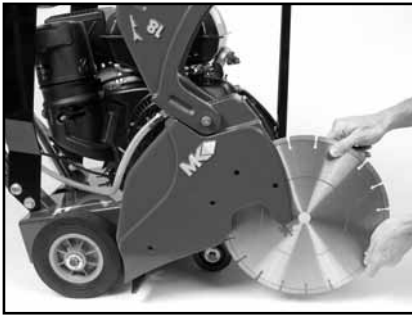

(A)  
Remove the Blade  
(See Blade Removal section).



(B)  
Locate and remove the Belt  
Guard Retaining Bolts and then  
remove the Belt Guard.

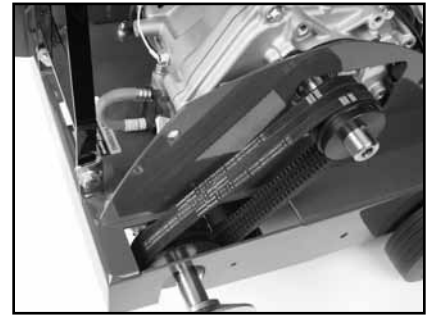

(C)  
Inspect the belt for excessive  
wear, cracks and cuts – if worn,  
proceed to Step E.

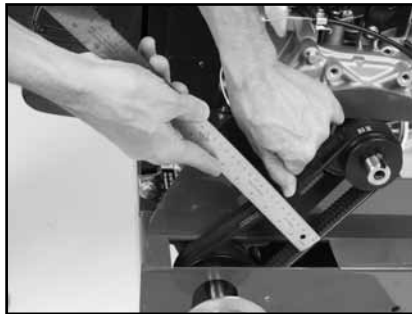

(D)  
Check belt for proper tension if ten-  
sion is correct, go to Step P (Proper  
tension is approximately 1/8-inch  
deflection of the belt).



(E)  
Locate the four upper Engine  
Mounting Nuts on both ends of  
the motor and loosen.



(F)  
Locate the four lower Engine  
Mounting Bolts on both ends of  
the motor and loosen.



(G)  
Loosen Jam Nut on Engine  
Tension Arm.



(H)  
Loosen the Engine Tension Arm  
adjusting nut. Push the Engine  
forward to loosen the belt.



(I)  
Remove the old belts from the  
Engine and Blade Shaft Pulleys.



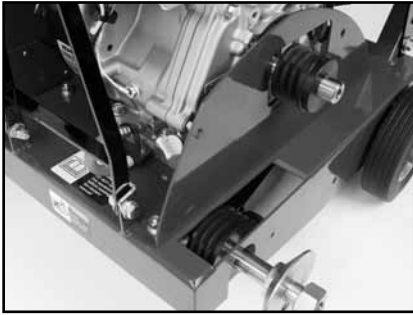

(J)  
Clean and verify the alignment of the Engine and Blade Shaft Pulleys.

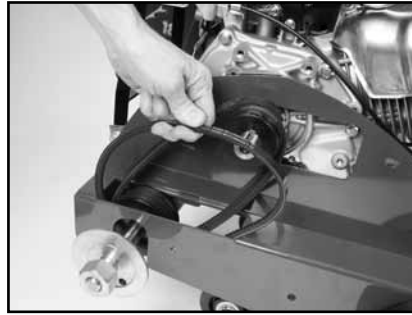

(K)  
Install new belts onto the Engine Blade Shaft Pulleys.

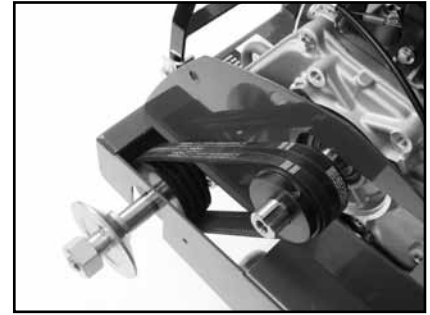

(L)  
Verify the belts are seated in all grooves of the Engine and Blade Shaft Pulleys.

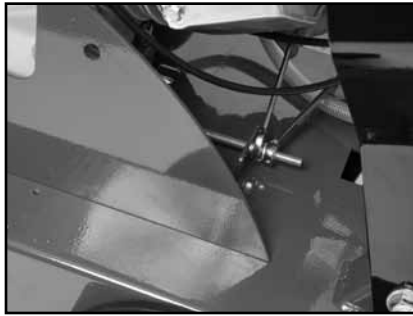

(M)  
Tighten the Engine Tension Arm Nuts.

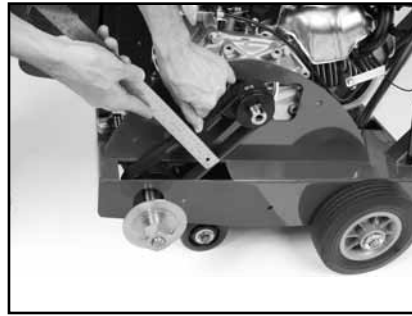

(N)  
Check belt for proper tension (Proper tension is approximately 1/8-inch deflection of the belt).

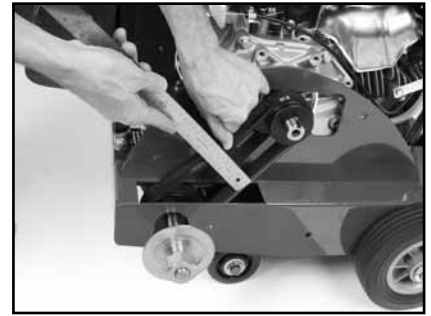

(O)  
Repeat Steps L and M until proper tension is achieved.



(P)  
Tighten the Engine Mounting Bolts.



(Q)  
Install the Belt Guard and Belt Guard Retaining Bolts.

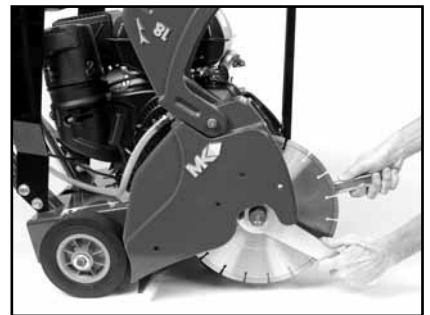

(R)  
Install the Blade (See Blade Installation section).

**TROUBLESHOOTING**

When trouble occurs, be sure to check the simple causes which, at first, may seem too obvious to be considered. Refer to the table below for problems and their possible causes.

	Cause Problem	No Fuel	Improper Fuel	Dirt in Fuel Line	Incorrect Oil Level	Dirty Air Filter	Faulty Spark Plugs
		ENGINE	Will not start	X		X	X
	Hard starting	X	X	X		X	X
	Stops suddenly	X		X	X	X	
	Lacks power		X	X	X	X	X
	Operates erratically		X	X		X	X
	Knocks or pings		X				X
	Skips or misfires			X		X	X
	Back fires			X		X	X
	Overheats			X		X	
	High Fuel Consumption					X	X
OTHER	Cause Problem	Improper Blade for the Application		Improper Belt Tension	Damage Caused by External Objects		
		Reduced blade life	X	X			
	Excessive belt wear			X		X	







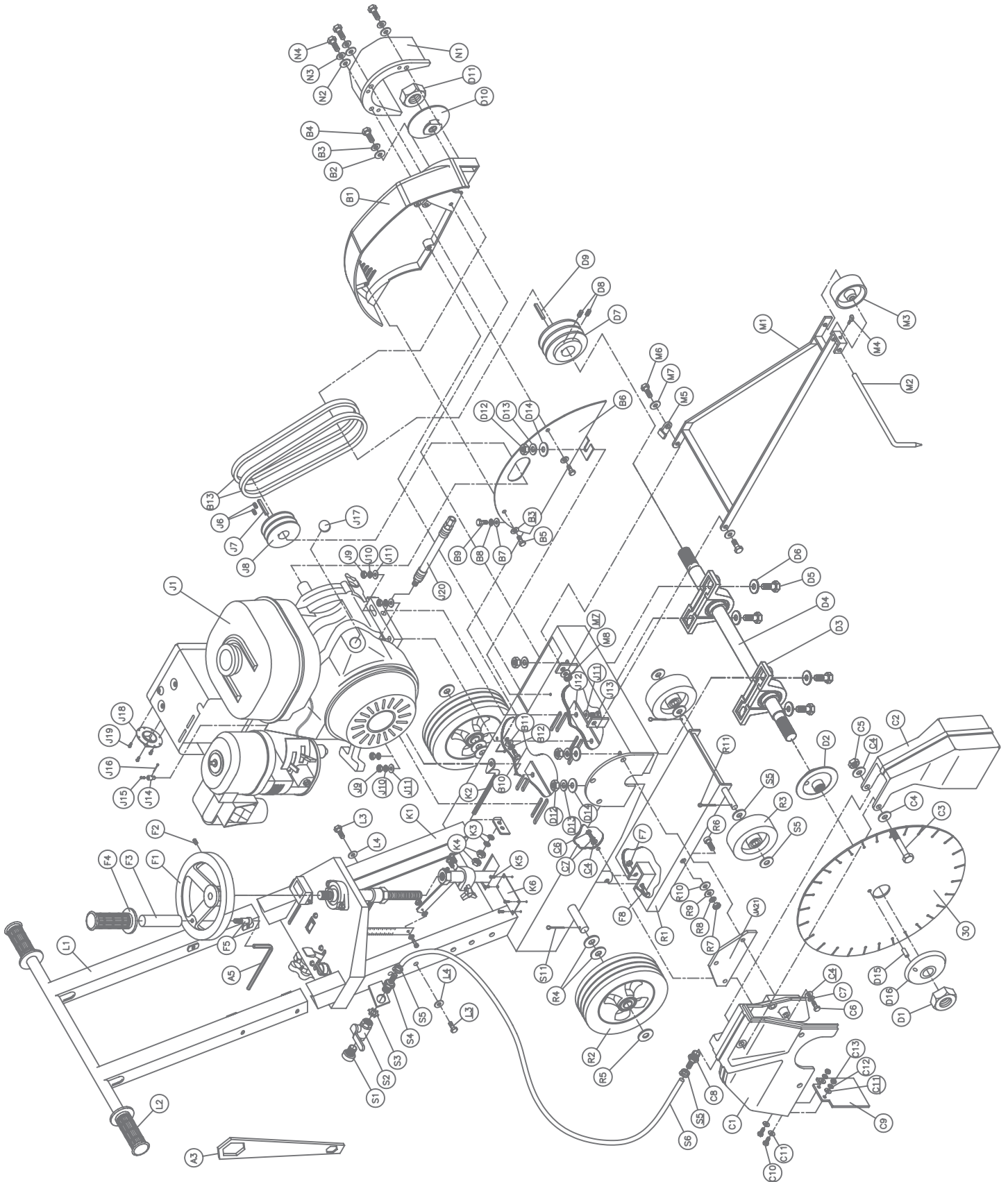

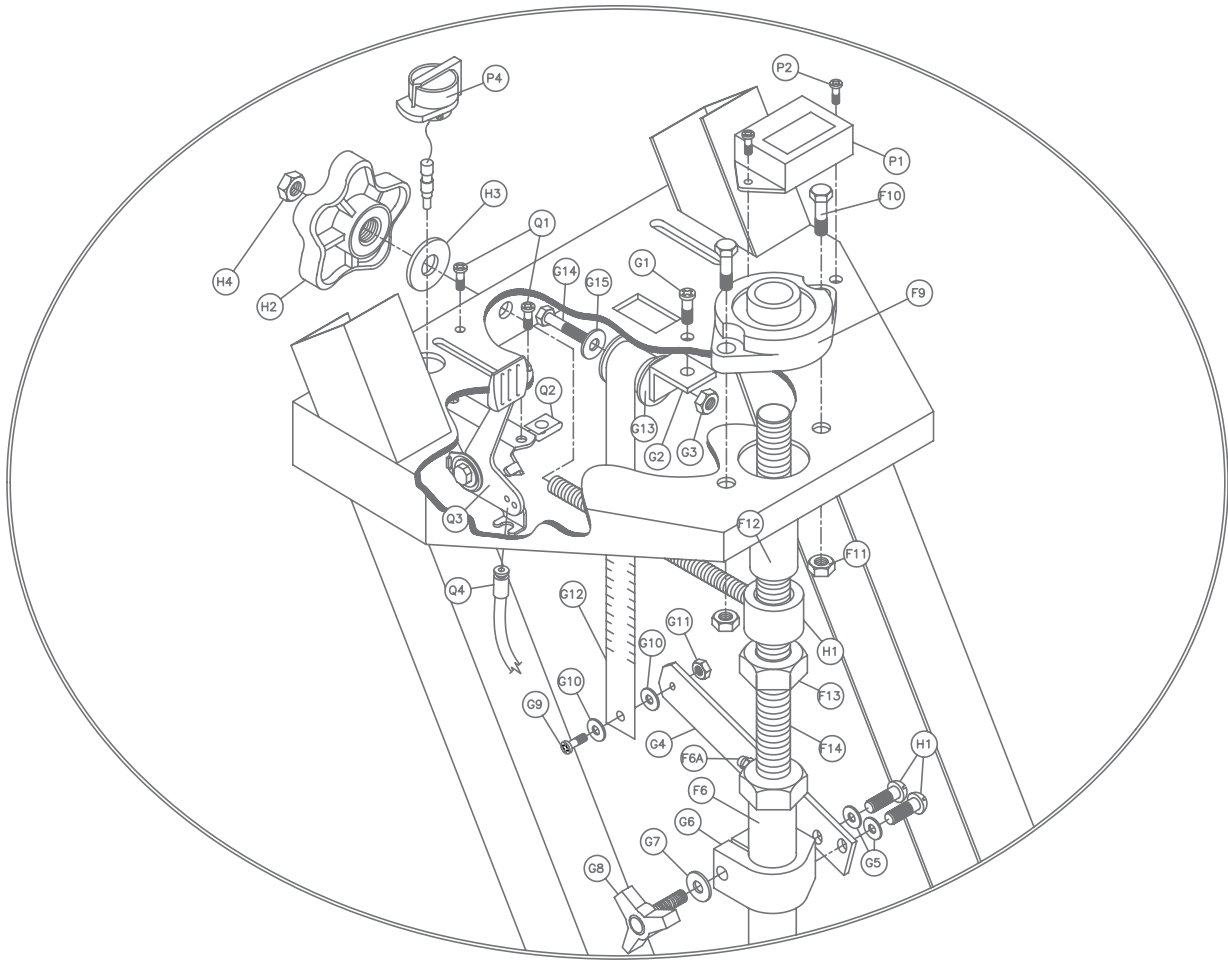

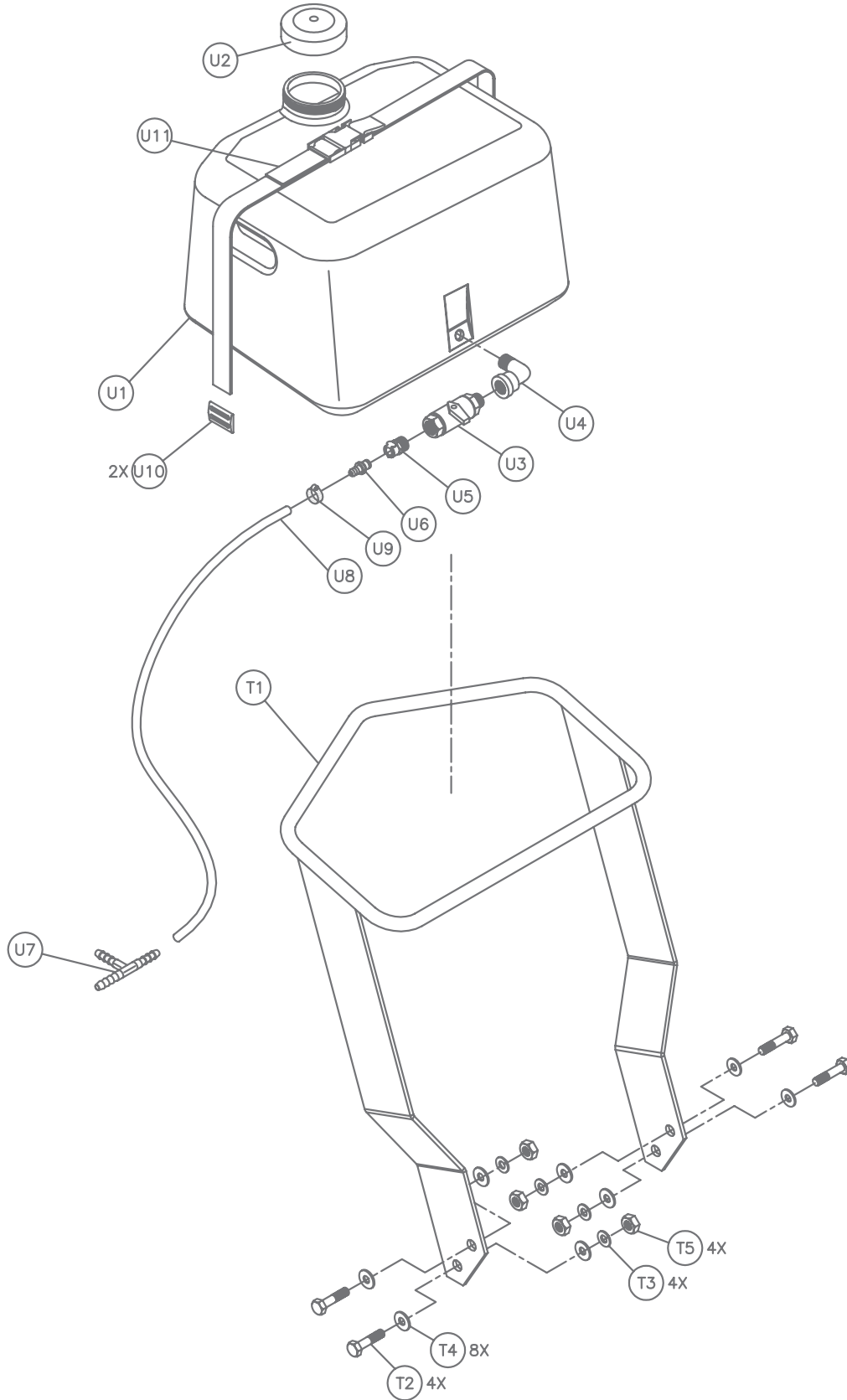

Item	Description	Qty	Part#
A1	Owner's Manual, MK-1600	1	157841
A2	Warranty Card	1	155859
A3	Wrench	1	137976
A4	Key, 1/4 Hex	1	156235
B1	Belt Guard	1	157704
B2	Washer, 5/16 SAE Flat	3	151754
B3	Washer, 5/16 Split Lock	3	151747
B4	Screw, 5/16-18 X 1 Hex Head Cap	1	151743
B5	Screw, 5/16-18 X 3/4 Hex Head Cap	2	151369
B6	Back Plate, Belt Guard	1	157705-DD
B7	Washer, 1/4 SAE Flat	1	151915
B8	Washer, 1/4 split lock	1	152591
B9	Screw, 1/4-20 X 1/2 Hex Head Cap	1	152608
B10	Screw, 3/8-16 X 3/4 Hex Head Cap	1	153527
B11	Washer, 3/8 SAE Flat	1	150923
B12	Washer, 3/8 Split Lock	1	150925
B13	Belt, 3VX280	3	160615
B14	Label, Caution, Belt Tension, 1.5 X 3.0	1	155583
B15	Label, Caution, Guards in Place, 1.5X3.0	1	155587
B16	Label, Caution, Sparkplug	1	155579
C1	18" Rear Blade Guard	1	159544
C2	18" Front Blade Guard	1	159645
C3	Screw, 3/8-16 X 4 Hex Head Cap	1	153531
C4	Washer, 3/8 SAE Flat	6	150923
C5	Nut, 3/8 - 16 X Nylock Hex	1	152505
C6	Nut, 3/8 - 16 X 1 Hex Head Cap	4	152507
C7	Washer, 3/8 split Lock	4	150925
C8	Fitting, Brass, 1/8 MNPT X Barb	1	152501
C9	Flap, Rubber Splash	1	150846
C10	Screw, 1/4 - 20 X 1/2 Hex Head Cap	2	152608
C11	Washer, 1/4 SAE Flat	4	151915
C12	Washer, 1/4 Split Lock	2	151893
C13	Nut, 1/4 - 20 Hex	2	151893
C14	Label, Caution, Lift Guard, 1.5 x 3.0	1	155586
C15	Label, Blade Failure Warning	1	155588
D1	Nut, Blade Shaft, 3/4 - 16 Left Hand	1	155069
D2	Flange, Inner, Left Hand	1	155068
D3	Bearing, 1" Pillow Block	2	155072
D4	Shaft, Blade, Premium	1	157842
D5	Screw, 7/16 - 14 X 1-1/2 Hex Head Cap	4	155155
D6	Washer, 1/2 SAE Flat	4	150924
D7	Pulley, 2 Groove, 3-1/4 x 1 Balde Shaft	1	160613
D8	Screw, 5/16-18 X 1/4 Socket Head Set	2	152607
D9	Key, Square, 1/4 X 1/4 x 1 3/4	1	150796
D10	Flange, Inner, Right Hand	1	157843
D11	Nut, Blade Shaft, 3/4 - 16 Right Hand	1	157844
D12	Nut, 7/16 - 14 Hex	4	150922
D13	Washer, 7/16 Split Lock	4	151051
D14	Washer, 7/16 SAE Flat	2	151050
D15A	Pin, 3/8 X 1 Type "A" Groove	1	152207
D15B	Flange, Outer	1	150732
F1	Depth Control Wheel	1	155156
F2	Screw, 3/8 - 16 X 1/2 Socket Head Set	1	153710
F3	Handle, Depth Control Wheel	1	156236
F4	Handgrip	1	150842
F5	Screw, 1/2 X 3/4 Socket Head Shoulder w/ 3/8-16 X 5/8 Thread	1	156177
F6	Tube, Depth Control	1	155049

Item	Description	Qty	Part#
F7	Nut, 3/8-16 Nylock Hex	1	152505
F8	Screw, 3/8-16 X 2 Hex Head Cap	1	153485
F9	Bearing, Flange, w/ zerk fitting	1	155151
F10	Screw, 3/8-16 X 1 1/4 Hex Head Cap	2	150774
F11	Nut, 3/8-16 Nylock Hex	2	152505
F12	Spacer, Depth Control	1	155161
F13	Nut, 3/4-10 Hex	1	155063
F14	Screw, Depth Control	1	155062
G1	Screw, 1/4 - 20 X 1/2 Pan Head Phillips Cap	1	152517
G2	Bracket, Depth Indicator	1	156608
G3	Nut, 1/4 - 20 Hex	1	151893
G4	Arm, Depth Indicator	1	156604
G5	Washer, 1/4 Split Lock	2	152591
G6	Clamp, Depth Indicator	1	156604
G7	Washer, 5/16 SAE Flat	1	151754
G8	Knob, Davies	1	151681
G9	Screw, 8 - 32 X 1/2 Pan Head Phillips Cap	1	152517
G10	Washer, #8 SAE Flat	2	155454
G11	Nut, 8 - 32 Hex	1	152549
G12	Spring, Depth Indicator	1	156605
G13	Spool, 1.0 Depth Indicator	1	157845
G14	Screw, 1/4 - 20 X 1 - 1/2 Hex Head Cap	1	152517
G15	Washer, 1/4 SAE Flat	1	151915
H1	Lock, 8 - 7/8 Depth Control	1	157846
H2	Knob, Depth Lock	1	155845
H3	Thrust Washer	1	155845
H4	Nut, 3/8 - 16 Nylock Hex	1	152505
J1	Engine, Honda GX390 13hp w/ Cyclone Air Filter	1	155365
JA1	Engine, Kohler command Pro CS 12 hp (not shown)	1	157831
JB1	Engine, Honda 8 Hp w/Cyclone Air Filter	1	155133
J2	Label, Caution, Hot Surface, 1.5 x 3.0	1	155578
J3	Label, Warning, Refueling, 1.5 X 3.0	1	155580
J4	Label, Danger, California, 1.5 X 3.0	1	155581
J5	Label, Danger, Lethal Exhaust, 1.5 X 3.0	1	155582
J6	Screw, 5/16-18 X 1/4 Socket Head Set	2	152607
J7	Key, Square, 1/4 X 1/4 x 1 3/4	1	150796
J8	Pulley, 2 Groove, 3/14 X 1 Engine Pully	1	160614
J9	Nut, 3/8-16 Hex	4	101188
J10	Washer, 3/8 Split Lock	4	150925
J11	Washer, 3/8 SAE Flat	7	150923
J12	Plate, Engine Bolt	2	157847
J13	Screw, 3/8-16 X 2 Hex Head Cap	4	153485
J14	Pin, Throttle Control	1	151284
J15	Screw, 8-32 X 3/8 Pan Head Cap	1	156614
J16	Pin, Cotter, 1/16 X 3/4	1	152518
J17	Plug, Plastic, 3/4 Round	1	156615
J18	Deflector, Honda 11/13HP	1	155375
J19	Screw, 6-32 X 1/2 Pan Head Phillips Self-tapping Cap	3	153466
J20	Oil Drain, Sub-assembly Adapter, M12-1.5 x 3/8 Push	1	157577-02
K1	Frame	1	157836-DD
K2	Arm, Tension	1	157848
K3	Washer, 5/16 SAE Flat	2	151754
K4	Nut, 5/16-18 Hex	2	101196
K5	Label, Private Label Serial Number	1	157458
K6	Label, Console	1	159950
K7	Label, Depth Lock, 1.04 X 3.25	1	155577
K8	Label, Operating Instructions, 3.5 X 6.0	1	155584
K9	Label, Caution, Hands and Feet, 2.0 X 4.0	1	155585

Item	Description	Qty	Part#
L1	Handlebar	1	159903
L2	Handgrip, Neoprene	2	157855
L3	Handlebar Plugs	2	156615
L4	Screw, 3/8-16 X 2 Hex Head Cap	2	153485
L5	Washer, 3/8 SAE Flat	2	150923
M1	Arm, Pointer	1	156544
M2	Pointer	1	155057
M3	Wheel, Pointer	1	155066
M4	Screw, 1/4-20 X 3/4 Thumb	2	150991
M5	Clip, Stop	1	157837
M6	Screw, 3/8-16 X 1 1/2 Hex Head Cap	2	153528
M7	Washer, 3/8 SAE Flat	4	150923
M8	Nut, 3/8-16 Nylock Hex	2	152505
N1	Guard, Shaft	1	156307
N2	Washer, 3/8 SAE Flat	3	150923
N3	Washer, 3/8 Split Lock	3	150925
N4	Screw, 3/8-16 X 1 Hex Head Cap	3	152507
N5	Label, Caution, Guards in Place, 1.5X3.0	1	155587
P1	Tachometer/ Hour meter	1	153877
P2	Screw, 8 - 32 X 1/12 Pan Head Phillips Self-Tapping Cap	2	156632
P3	Wire Harness, Premium, Honda (not Shown)	1	156633
P4	Switch, Engine On/Off	1	157851
Q1	Screw, 10-24 X 1/2 Pan Head Phillips Cap	2	151744
Q2	Nut, 10-24 Clip	2	155407
Q3	Assembly, Throttle Head	1	155406
Q4	Cable, Throttle, Honda	1	154158
R1	Truck	1	155048
R2	Wheel, Rear, 8 X 2 1/4	2	155986
R3	Wheel, Front, 4 X 1 1/2	2	150830
R4	Washer, 3/4 SAE Flat	4	153523
R5	Washer, 3/4 Shim	6	153699
R6	Screw, 1/2 X 1/2 Socket Head Shoulder, w/ 3/8-16 X 5/8 Thread	2	151753
R7	Nut, 3/8-16 Hex	2	101188
R8	Washer, 3/8 Split Lock	2	150925
R9	Washer, 3/8 SAE Flat	3	150923
R10	Washer, 1/2 SAE Flat	2	150924
R11	Pin, Cotter, 1/8 X 1 1/2	4	153861
<b>S</b>	<b>Assembly, Water Valve</b>	<b>1</b>	<b>155458</b>
S1	Fitting, Brass, 1/2 MNPT X Garden Hose Swivel	1	151322
S2	Valve, Shut-Off, 1/2 FNPT X 1/2 FNPT	1	150843
S3	Nut, 1/2 NPT	1	152729
S4	Fitting, Brass, 1/2 MNPT X 3/8 BARB	1	153653
S5	Clamp, 5/8 Hose	2	151198
S6	Hose, 3/8 ID Vinyl	30'	150845
T	Assembly, Lifting Bail (premium only)	1	157853
T1	Lifting Bail	1	157745
T2	Screw, 1/2-13 X 1 1/4 Hex Head Cap	4	153532
T3	Washer, 1/2 Split Lock	4	153524
T4	Washer, 1/2 SAE Flat	8	150924
T5	Nut, 1/2-13 Hex	4	151282
<b>U</b>	<b>Assembly, Water Tank (optional)</b>	<b>1</b>	<b>157852</b>
U1	Tank, Water	1	156644
U2	Cap	1	156956
U3	Valve, Shut Off	1	152075
U4	Elbow, 90°	1	152074
U5	Fitting	1	152076
U6	Tee, 3/8 Hose Barb, Brass	1	156645
U7	Hose, 3/8 I.D. Vinyl	2'	150845
U8	Hose Clamp, 3/8	4	151198

## THEORY OF DIAMOND BLADES

---

Diamond blades do not really cut; they grind the material through friction. Diamond crystals, often visible at the leading edge and sides of the rim/segment, remove material by scratching out particles of hard, dense materials, or by knocking out larger particles of loosely bonded abrasive material. This process eventually cracks or fractures the diamond particle, breaking it down into smaller pieces. As a result, a diamond blade for cutting soft, abrasive material must have a hard metal matrix composition to resist this erosion long enough for the exposed diamonds to be properly utilized. Conversely, a blade for cutting a hard, non-abrasive material must have a soft bond to ensure that it will erode and expose the diamonds embedded in the matrix. These simple principles are the foundation of “controlled bond erosion”



### Types of Cutting

There are two basic types of cutting-Dry or Wet. The choice of which type of blade to use depends on:

- The requirements of the job
- The machine/tool utilizing the diamond blade
- The preference of the operator









In the case of DRY cutting, the overwhelming popularity and quantity of hand-held saws and the flexible nature of MK Diamond blades to professionally handle most ceramic, masonry, stone and concrete materials, make the DRY cutting blade a very attractive tool. When using a DRY blade, the user must be aware of distinct operating practices to ensure optimum performance. DRY cutting blades require sufficient airflow about the blade to prevent overheating of the steel core. This is best accomplished by shallow, intermittent cuts of the material with periods of “free-spinning” (for several seconds) between each cut, to maximize the cooling process.

For WET cutting applications, MK has the exact blade to compliment both the material to be cut and the wet cutting machine to be used. During cutting operations, liberal amounts of water act as a coolant to support the cutting effectiveness and longevity of the WET blade. Additionally, using water adds to the overall safety of cutting operations by keeping the dust signature down.

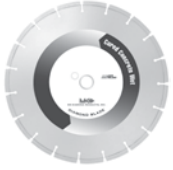
Know All You Can About the Material You Wish to Cut



## ACCESSORIES

ITEM	NUMBER	DESCRIPTION	
1	134965	MK-500 18" x .125 x 1" Standard grade wet cutting blade for cured concrete	
2	129072	MK-505 18" x .125 x 1" Premium grade, wet cutting blade for cured concrete	
3	134965	MK-525 18" x .125 x 1" Supreme grade, wet cutting blade for cured concrete	
4	133850	MK-705W 18" x .142 x 1" Premium grade, wet cutting blade for asphalt	
5	139162	MK-610W 18" x .142 x 1" Supreme grade, wet cutting blade for green concrete	
6	153550	MK-465D 18" x .142 x 1" Premium grade, dry cutting blade for asphalt and green concrete	
7	157852	6.5 Gallon Water Tank	
8	157745	Lifting Bail	

## **ORDERING INFORMATION**

---

You may order MK Diamond products through your local MK Diamond distributor or, you may order direct from MK Diamond.

When ordering direct from MK Diamond, please have the following information ready before calling:

- The Model Number of the saw
- The Serial Number of the saw
- Where the saw was purchased and when
- The Part Number for the part(s) being ordered
- The Part Description for the part(s) being ordered

**NOTE:** There is a \$25.00 minimum order when ordering direct from MK Diamond. A \$5.00 charge will be added to orders having a net billing value under \$50.00. All purchases must be made using VISA, MasterCard or American Express.

All parts may be ordered by calling toll free to – 800 421-5830 or 310 539-5221 and asking for Customer Service. For technical questions, call – 800 474-5594.

## **RETURN MATERIALS POLICY**

---

To expedite the service relative to the return of a product purchased through MK Diamond, please observe the following:

**NOTE:** When returning all items, they must have been purchased within the previous twelve (12) months.

- Have the Model Number of the saw
- Have the Serial Number of the saw
- Have the location of where the saw was purchased
- Have the date when the saw was purchased
- Contact Customer Service for approval to return the item(s)
- Obtain a Returned Goods Number (RGA) authorizing the return
- Follow the packaging instructions in the following section
- Ensure your item(s) are prepaid to the destination

For returned items, call toll free to – 800 421-5830 or 310 539-5221 and ask for Customer Service. For technical questions, call – 800 474-5594 or 310 257-2845.

## **PACKAGING INSTRUCTIONS**

---

- Remove the Cutting Head and Support Angle Assembly
- Dry the saw before shipping
- When packing, include the following: Saw, Diamond Blade, Blade Guard and Support Angle Assembly and Adjustable Cutting Guide (Other Accessories are not required)
- Package the unit in its original container or one of comparable size (do not ship the unit partially exposed)
- Ensure all parts are secured in the packaging to prevent moving

## **AUTHORIZED SERVICE CENTERS**

---

For quicker repair time, you may contact MK Diamond Customer Service, toll free, at 800 421-5830 or 310 539-5221 for the Authorized Service Center closest to you or visit our web site at [www.mkdiamond.com](http://www.mkdiamond.com). For technical questions, call – 800 474-5594.

**CONTACT:**

Please contact MK Diamond Products, Inc. Customer Service Department with any questions you might have regarding distributors, parts or service.

Telephone: **(800) 421-5830**

Fax: **(310) 539-5158**

E-mail: **Customer\_Service@MKDiamond.com**

Customer Service Hours: **Monday through Friday, 6AM-4PM PST**

**MK Diamond Products, Inc.  
1315 Storm Parkway  
Torrance, CA 90501**

**MK DIAMOND PRODUCTS, INC. LIMITED WARRANTY**

MK DIAMOND PRODUCTS, INC. will guarantee every machine they build, to be free from defects in material and workmanship for (1) one year from date of purchase. The obligation of MK DIAMOND PRODUCTS, INC. under this warranty is limited to the repair or replacement of any parts which, under normal use, prove to be defective in material or workmanship. The parts involved or the unit in question should be returned to MK DIAMOND PRODUCTS, INC. or to a point designated by us, transportation prepaid.

This warranty does not obligate us to bear the cost of labor or transportation charges in connection with replacement or repair of defective parts. Likewise, it shall NOT apply to any unit which has been subjected to misuse, neglect or accident. This warranty does NOT apply to any machine which has been repaired or altered outside our factory.

This warranty does NOT obligate MK DIAMOND PRODUCTS, INC., with respect to items not of our manufacture, such as engines, motors, hydraulics, etc., which are subject to their own guarantees and warranties.

We shall in no event be liable for consequential damages or contingent liabilities arising out of failure of any equipment or parts to operate properly.

**© COPYRIGHT 2012, MK DIAMOND PRODUCTS, INC. ALL RIGHTS RESERVED.**

The MK Diamond logo is a registered trademark of MK Diamond Products, Inc. and may not be used, reproduced, or altered without written permission. All other trademarks are the property of their respective owners and used with permission.

MK Diamond may have patents, patent applications, trade marks, copyrights of other intellectual property right covering this product in this document.

This manual MUST accompany the equipment at all times. This manual is considered a permanent part of the equipment and should remain with the unit if resold.

The information and specifications included in this publication were in effect at the time of approval for printing.

**MK-1600 CONCRETE SAW**  
**OWNERS MANUAL & OPERATING INSTRUCTIONS**



**MK Diamond Products, Inc.**

MK Diamond Products, Inc.  
1315 Storm Parkway  
Torrance, CA 90501

Toll-Free: (800) 421-5830  
Phone: (310) 539-5221  
Fax: (310) 539-5158  
[www.mkdiamond.com](http://www.mkdiamond.com)