

**QUICKDRAIN USA™**



NOT JUST A  
**LINEAR DRAIN**

THE  
**SHOWER PAN**  
SOLUTION







## WINNERS OF:

Best Bath Product - 2014 IBS  
 Top 10 Requested Product - 2013 KBDN

## IPC AND UPC CERTIFIED

IAPMO and ICC  
 ADA (ANS# 117.1)



# CONTENTS

<b>THE QUICKDRAIN ADVANTAGE</b>	<b>2</b>
Advantages of QuickDrain USA Shower Drains	3
<b>STANDARD DRAINS</b>	<b>4</b>
Sink Drain	5
Drain Covers	6
<b>CUSTOM DRAINS</b>	<b>8</b>
Non-Standard Size	9
Commercial Waste Outlet	9
Side Waste Outlet	10
Resinous Flooring Drains	10
Multiple Waste Outlets	11
<b>ACCESSORIES</b>	<b>12</b>
<b>INSTALLATIONS</b>	<b>14</b>
Installation Cutaway	14
Critical Installation Tips & Spacers	15
Drain Placement - Accessible showers	16
Drain Placement When Accessibility is Not Required	17
Drain Installation Details	18
<b>EASY ORDER GUIDE</b>	<b>24</b>
Drain Assembly	24
QuickDrain Shower Pan System	26
<b>SUGGESTED MATERIALS FOR COMMON SHOWERS</b>	<b>28</b>
<b>STEPS FOR PLANNING YOUR NEW SHOWER</b>	<b>29</b>

# THE QUICKDRAIN ADVANTAGE

Our channel drain system features superior engineering and design. Among its greatest advantages, the individual QuickDrain system components provide the versatility to achieve nearly any shower pan configuration imaginable.

QuickDrain enables a sleek, luxurious shower design by banishing the old-fashioned center shower drain. Uniquely, our system easily installs directly on the subfloor of the shower entrance, eliminating the need to recess the subfloor, resulting in significant cost and labor savings. All the features of our shower drain system are designed to be at the forefront of technology and performance, while retaining ease of installation and a beautiful finished look.

Using the complete QuickDrain system, most contractors are able to complete installation within three to five hours the very first time. Our system will be up and running in no time with a superior product!



*Standard Drain in Center*



*Shower Door Installation*



*Shower Wall Installation*

## ADVANTAGES OF QUICKDRAIN USA SHOWER DRAINS

QuickDrain USA allows you to create a curbless and/or ADA shower while using large-format tile or floor material.

Our unique stackable spacers allow you to easily adjust the height of the drain cover to be flush with the floor.

The narrow, sleek and stylish drain will help you create an elegant shower with a touch of sophistication.

Our TileIn cover virtually makes the drain disappear.

With QuickDrain USA systems, the shower floor can be completed in a day.

The 100% sloped trough is designed to remove all water and debris.

The standard center point drain, shown above left, requires smaller tile and a lot of labor to create a bowl-shaped floor - a difficult installation leading to an unsightly result. QuickDrain presents the clear advantage with its easy-to-install system and attractive design.

QuickDrain is perfect for all uses, including the home and commercial projects such as hotels, hospitals, condominiums, and healthcare facilities.

Our easy-to-install, customizable Quick Slope flooring quickly brings your shower floor to the standard 2% slope needed for all shower floors.



## STANDARD DRAINS

Standard drains are internally pitched so that no water will be sitting in the trough after each use.

### Other design features include:

A channel drain body with horizontal flanges.

An integral factory-attached waterproofing membrane 6" around the trough ensures a watertight connection to the drain.

A 2" waste down spout is used for an outlet, which is located either in the center for 26", 27½", 46", 63" and 68" models or 3" off center for 30", 36", 40", 44", 48", 52" and 57" models. Off-center drains can be turned 180° to avoid floor joists or other obstructions in the floor. Standard flow rate with single outlet is 10gpm (5 gpm when used at the entry to a curbless shower as a primary shower drain). Additional outlets can be added for a higher flow rate. See page 11.

Custom lengths available 10" to 100".

All drain bodies are made from 18 gauge 316L marine grade corrosive resistant stainless steel.

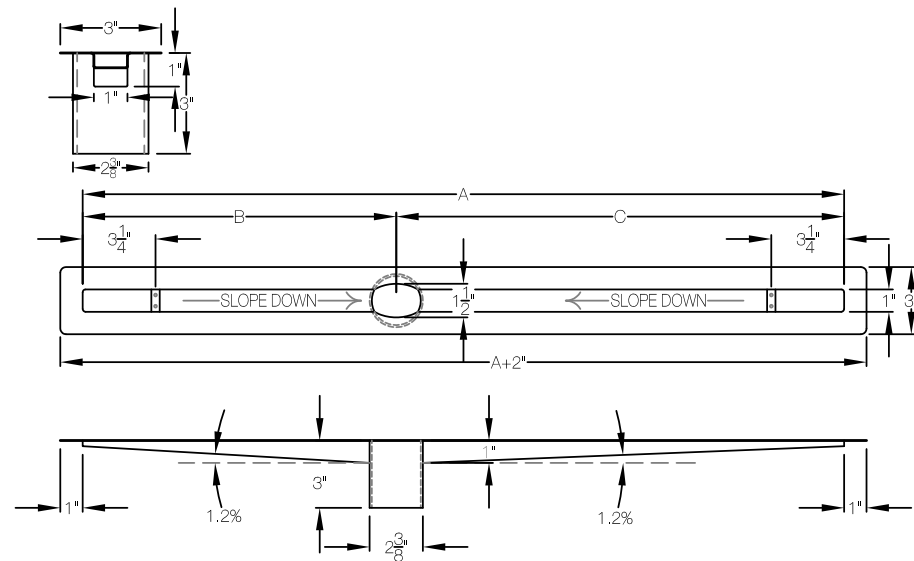

ITEM NUMBER - DIMENSIONS												
	PLD26	PLD27.5	PLD30	PLD36	PLD40	PLD44	PLD46	PLD48	PLD52	PLD57	PLD63	PLD68
<b>A</b>	26"	27.5"	30"	36"	40"	44"	46"	48"	52"	57"	63"	68"
<b>B</b>	13"	13.75"	12"	15"	17"	19"	23"	21"	23"	25.5"	31.5"	34"
<b>C</b>	13"	13.75"	18"	21"	23"	25"	23"	27"	29"	31.5"	31.5"	34"
<b>D</b>	28"	29.5"	32"	38"	42"	46"	48"	50"	54"	59"	65"	70"

## SINK DRAIN

A channel drain body with horizontal flanges for use with a custom-made sink.

NOT SUITABLE FOR FLOOR DRAIN

The sink drain does NOT come with the integral factory-attached waterproofing membrane.

The drain body is made from 18 gauge 316L marine grade corrosive resistant stainless steel. It has a 1 ½" vertical waste outlet. A side waste outlet is available as a custom option, with additional production time.

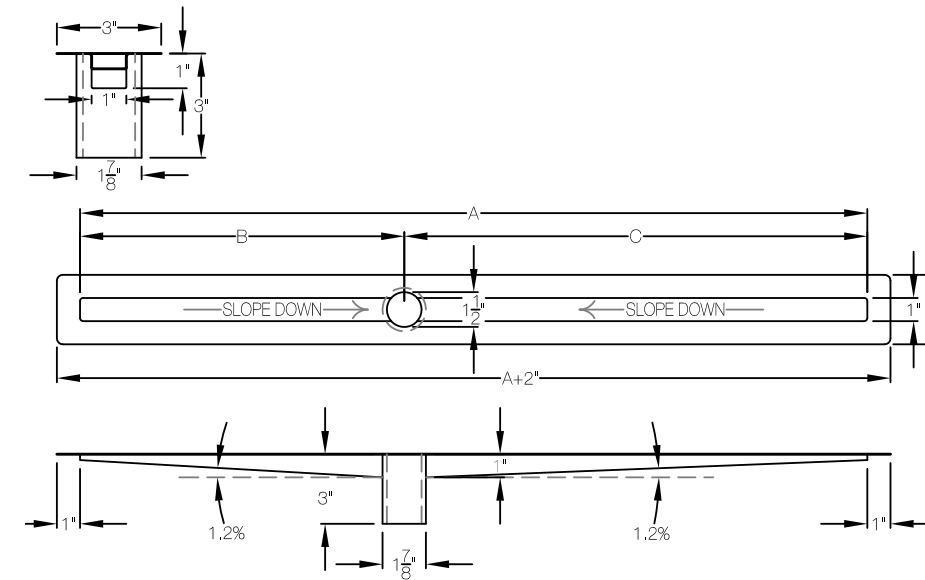

ITEM NUMBER - DIMENSIONS	
<b>A</b>	18"
<b>B</b>	9"
<b>C</b>	9"
<b>D</b>	20"



**DRAIN COVERS** 4 attractive patterns to accent your shower

# MICHAEL GRAVES DESIGN™

World-renowned Architect & Designer Michael Graves and QuickDrain USA have developed a partnership to introduce some of the most alluring cover designs in the industry.

Crafted from durable 18 gauge or solid 304 stainless steel. Made with the quality you've come to expect and proven virtually indestructible. Per code, the slim drain cover is removable. Custom lengths available 10" to 120" (COSMO & TILEIN) and 10" to 70" (STREAM & LINES).



**STREAM**

*Available finishes: Brushed & Oil-Rubbed Bronze*



**COSMO**

*Available finishes: Brushed, Polished & Oil-Rubbed Bronze*

## QUICKDRAIN USA™ ORIGINALS



**LINES**

*Available finishes: Brushed & Oil-Rubbed Bronze*



**TILEIN**

*Insert your own tile*



*Stream Cover  
Installation Example*



*Lines Cover  
Installation Example*

LENGTH	ITEM NUMBER			
	STREAM	COSMO	LINES	TILEIN
18	STREAM18	COSMO18	LINES18	TILEIN18
28	STREAM28	COSMO28	LINES28	TILEIN28
30	STREAM30	COSMO30	LINES30	TILEIN30
36	STREAM36	COSMO36	LINES36	TILEIN36
40	STREAM40	COSMO40	LINES40	TILEIN40
44	STREAM44	COSMO44	LINES44	TILEIN44
46	STREAM46	COSMO46	LINES46	TILEIN46
48	STREAM48	COSMO48	LINES48	TILEIN48
52	STREAM52	COSMO52	LINES52	TILEIN52
58	STREAM58	COSMO58	LINES58	TILEIN58
63	STREAM63	COSMO63	LINES63	TILEIN63
68	STREAM68	COSMO68	LINES68	TILEIN68

# CUSTOMIZABLE, SIMPLE, ECONOMICAL & ADA COMPLIANT

## CUSTOM DRAINS

We understand your project, residential or commercial, may need something special. That's why we have always offered to create custom solutions for you. Custom drains can be made for any size in any situation. Our drain designs can be made in any size increment between 10" and 100" long. QuickDrain can also customize and add multiple waste outlets to accommodate high-flow capacity for more demanding projects. Custom drain bodies can also be made with threaded waste outlet(s).

\*Note: All custom drains are not a stock item and will add production time.

## NON-STANDARD SIZE

Custom drains made in any size increment between 10" and 100" long.

Maximum size with one waste outlet is 68" total length not including the flanges. Drains longer than 68" must have two waste outlets per trough due to the depth, length and internal pitch of the trough.

## COMMERCIAL WASTE OUTLET

Commercial facilities have special requirements. To meet fireproofing codes, waste outlets can be made in custom lengths from 2" to 14" below the trough. Longer pipes allow waste lines to go through concrete floor so the plumbing connection is done below fireproofing.

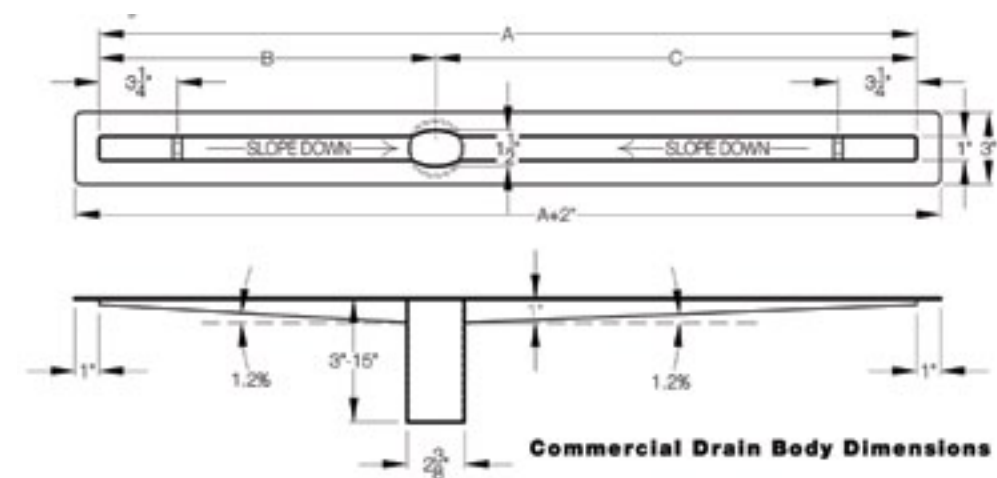

*Almost any location of waste outlets and flow volume can be achieved with this system.*



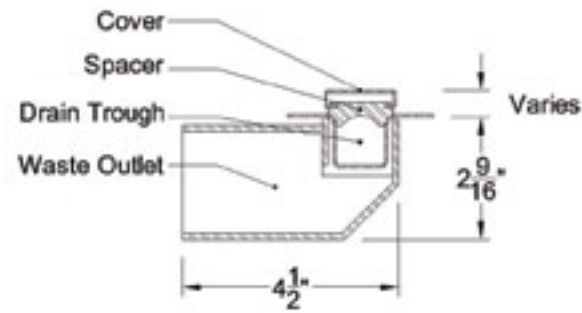

## SIDE WASTE OUTLET

Primarily used in retrofitting situations when there are limitations on space and location of existing floors and outlets. The side waste outlet drops and turns 90 degrees and is only 2 9/16" deep, eliminating the need to drill through concrete.

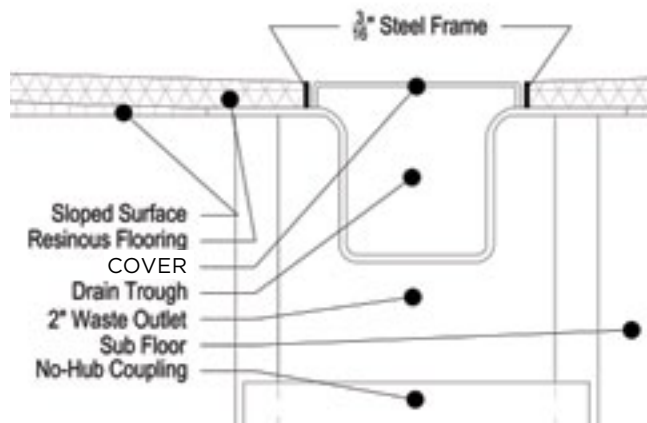
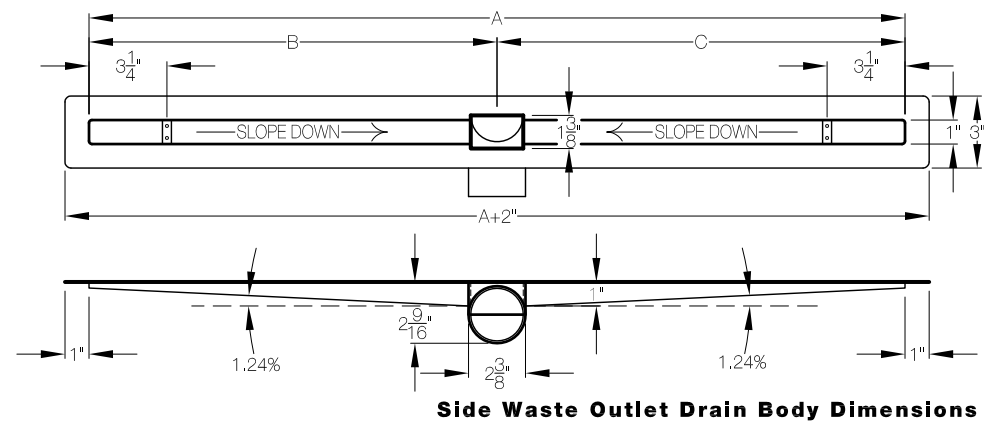

## RESINOUS FLOORING DRAINS

These drains are suitable for epoxy, urethane and sheet vinyl flooring, making them ideal for commercial use. Total height from waterproofing to the finished floor is 3/16". Since sheet waterproofing is not a typical part of a resinous/ vinyl flooring system, this drain does not come with the waterproof membrane attached to the drain body.

## MULTIPLE WASTE OUTLETS

Water flow output of more than 10 gallons per minute can be addressed with additional outlets on the drain body. QuickDrain waste outlets can accommodate this increased flow. While the appearance is similar to a standard drain, these solutions can double or triple water flow capacity.

The drawings below show the standard locations of waste outlets.

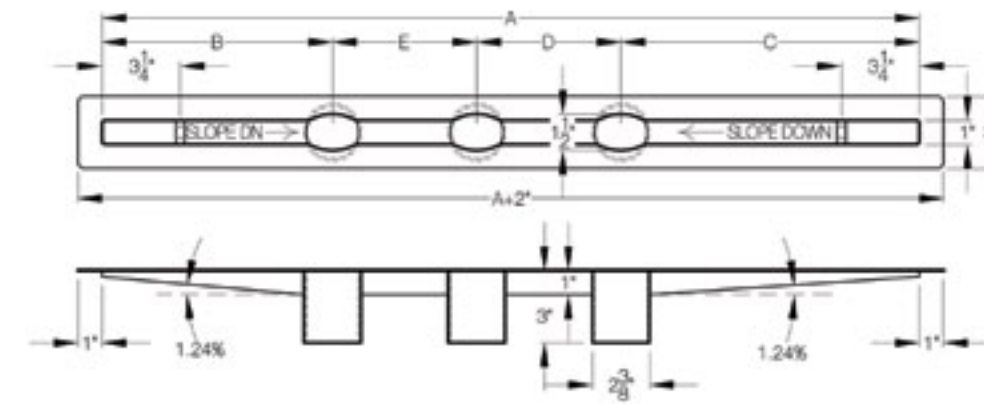
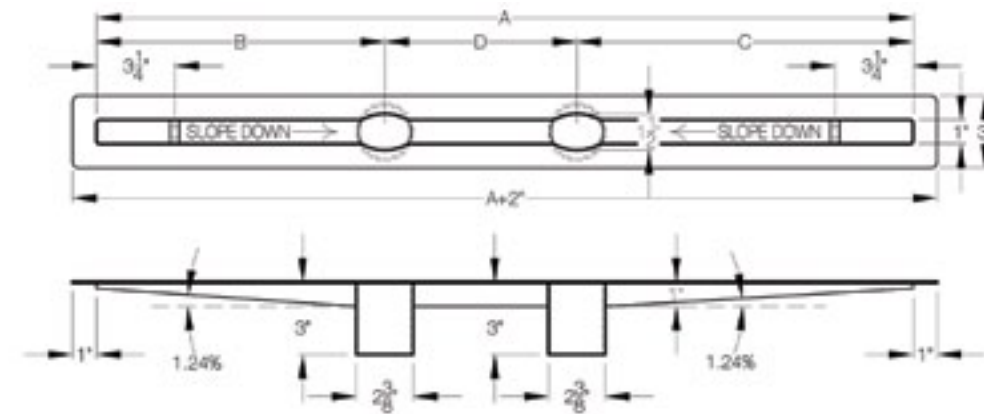

Almost any location of waste outlets and flow volume can be achieved with this system.

# ACCESSORIES

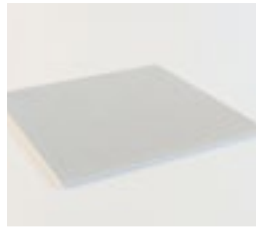

Flat Panel

### QS30P - Quick Slope

30" x 30" x 1/8" to 3/4" prefabricated one-way sloping material made of polypropylene honeycomb that is pre-cut at a 2% pitch. Leading edge at the drain 1/8"; trailing edge away from drain 3/4". Compression strength of 230 psi. Cuts with utility knife.



Quick Slope Panel

### QS60SS - Quick Slope

30" x 60" x 1/8" to 1-3/8" prefabricated one-way sloping material made of polypropylene honeycomb that is pre-cut at a 2% pitch. Leading edge at drain (30" side) 1/8"; trailing edge away from drain 1-3/8". Ideal for tub-to-shower conversions where waste line is below the subfloor. Compression strength of 230 psi. Cuts with utility knife.

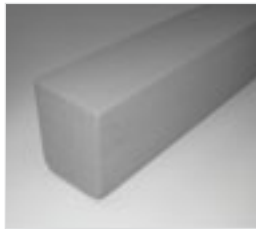

Curb Form

### QS8PP - Quick Slope

30" x 8" x 1/8" to 3/8" prefabricated one-way sloping material made of polypropylene honeycomb that is pre-cut at a 2% pitch. Leading edge at the drain 1/8"; trailing edge away from drain 3/8". Ideal for drain placement that is 8" or less from wall. Compression strength of 230 psi. Cuts with utility knife.



Waterproofing

### FP30P - Flat Panel

30" x 30" x 5/8" flat sheet of polypropylene honeycomb with a veil for thinset adhesion. Serves as an extension for slopes or shower pans with a run larger than 30". Quick Slope is placed on top of the Flat Panel to extend the slope. Compression strength of 230 psi. Cuts with utility knife.

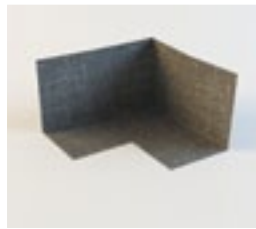

Corner (Inside)

### FP30P1 - Flat Panel

30" x 30" x 1" flat sheet of polypropylene honeycomb with a veil for thinset adhesion. Serves as a filler under Quick Slope for above-floor installations. Compression strength of 230 psi. Cuts with utility knife.



Corner (Outside)

### FP60P1 - Flat Panel

30" x 60" x 1" flat sheet of polypropylene honeycomb with a veil for thinset adhesion. Serves as a filler under Quick Slope for above-floor installations. Ideal for tub-to-shower conversions where the drain is set above subfloor. Compression strength of 230 psi. Cuts with utility knife.

### FP60P3 - Flat Panel

30" x 60" x 3" flat sheet of polypropylene honeycomb with a veil for thinset adhesion. Serves as a filler under Quick Slope for above-floor installations. Ideal for tub-to-shower conversions where there is no penetration into the subfloor and waste line is in the chase behind the wall. Used with side outlet drains. Compression strength of 230 psi. Cuts with utility knife.

### CURB3 - Curb Form - 3"

2-1/2" x 3-1/2" x 61" curb form made from rigid PET foam. Ideal for tub-to-shower conversions where waste line is below the subfloor. Compression strength of 270 psi. Cuts with utility knife.

### CURB5 - Curb Form - 5"

2-1/2" x 5" x 61" curb form made from rigid PET foam. Ideal for tub-to-shower conversions where there is no penetration into the subfloor and waste line is in the chase behind the wall. Used with side outlet drains. Compression strength of with 270 psi. Cuts with utility knife.

### QTS39 - Waterproofing - 39" Wide

39" wide sheet of waterproofing pan liner membrane used to create a watertight shower pan. Sold by the linear foot.

### QTS78 - Waterproofing - 78" Wide

78" wide sheet of waterproofing pan liner membrane used to create a watertight shower pan. Sold by the linear foot.

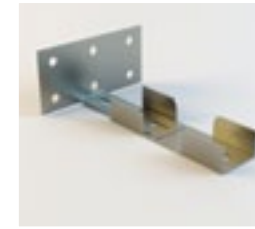

Leveling Bracket (Short)

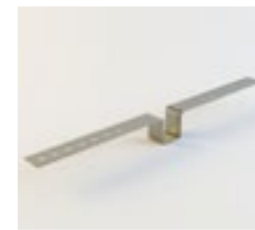

Placement Bracket



In-Line Cover Connector



QuickSeal Membrane



Trough Extension

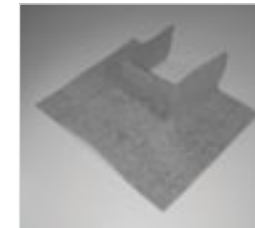

Curb Cover

### QS007 - QuickSeal Membrane Adhesive

Used to join two pieces of membrane together and create a watertight seam.

### QDMUS - Modified Urethane Sealant 10.2 oz.

Used to join two pieces of membrane together and create a watertight seam specifically in inside & outside corners & curb covers. Also to provide an easy-to-install capillarity break.

### QTSCC - Curb Cover

Pre-formed u-shaped waterproofing membrane intended to hug wall and curb joint.

### QTSOC - Outside Corner

Pre-formed waterproofing membrane intended to hug 90-degree outside corners.

### QTSIC - Inside Corner

Pre-formed waterproofing membrane intended to hug 90-degree inside corners.

### PLBSS - Placement Bracket

Metal saddle for drain body. Set directly into recess in subfloor. Used to keep drain parallel and set the correct distance from drain to wall. To be used for installation that is level with the subfloor.

### LVBSS - Leveling Bracket - Short

Metal saddle with two leveling screws, one setscrew and L-shaped wall connector. One bracket is placed on either end of drain to keep drain parallel and set the correct distance from drain to wall. To be used for installation that is above the subfloor. Distance between drain and wall may be set up to 3".

### LVBSL - Leveling Bracket - Long

Metal saddle with two leveling screws, one setscrew and L-shaped wall connector. One bracket is placed on either end of drain to keep drain parallel and set the correct distance from drain to wall. To be used for installation that is above the subfloor. Distance between drain and wall may be set up from 3" to 6".

### EX4SS - Trough Extension

Used on top of waterproofing as a trough extension where the cover is longer than the trough itself.

### ILCSS - In-Line Cover Connector

Connects multiple COSMO covers in a line.

### NH2-2 - No-hub Coupling

2" to 2"

### NH2-1 1/2" - No-hub Coupling

2" to 1 1/2"

## Plumbing Code Listings and Approvals

Standard drains and the QuickLiner waterproof membrane are UPC and PMG listed.

**Standard drains** — UPC & CUPC listing#: 6181 and PMG listing#: 1042 - Meets or exceeds ASME A112.18.2-2005

**Membrane** — UPC listing #: 5130 and PMG listing#: 1105 - Meets or exceeds ANSI A118.10-2008

Please contact your local building official before installation to ensure local building code compliance. Go to [www.QuickDrainUSA.com](http://www.QuickDrainUSA.com) for updates on listings and approvals.





# INSTALLATIONS

## INSTALLATION CUTAWAY

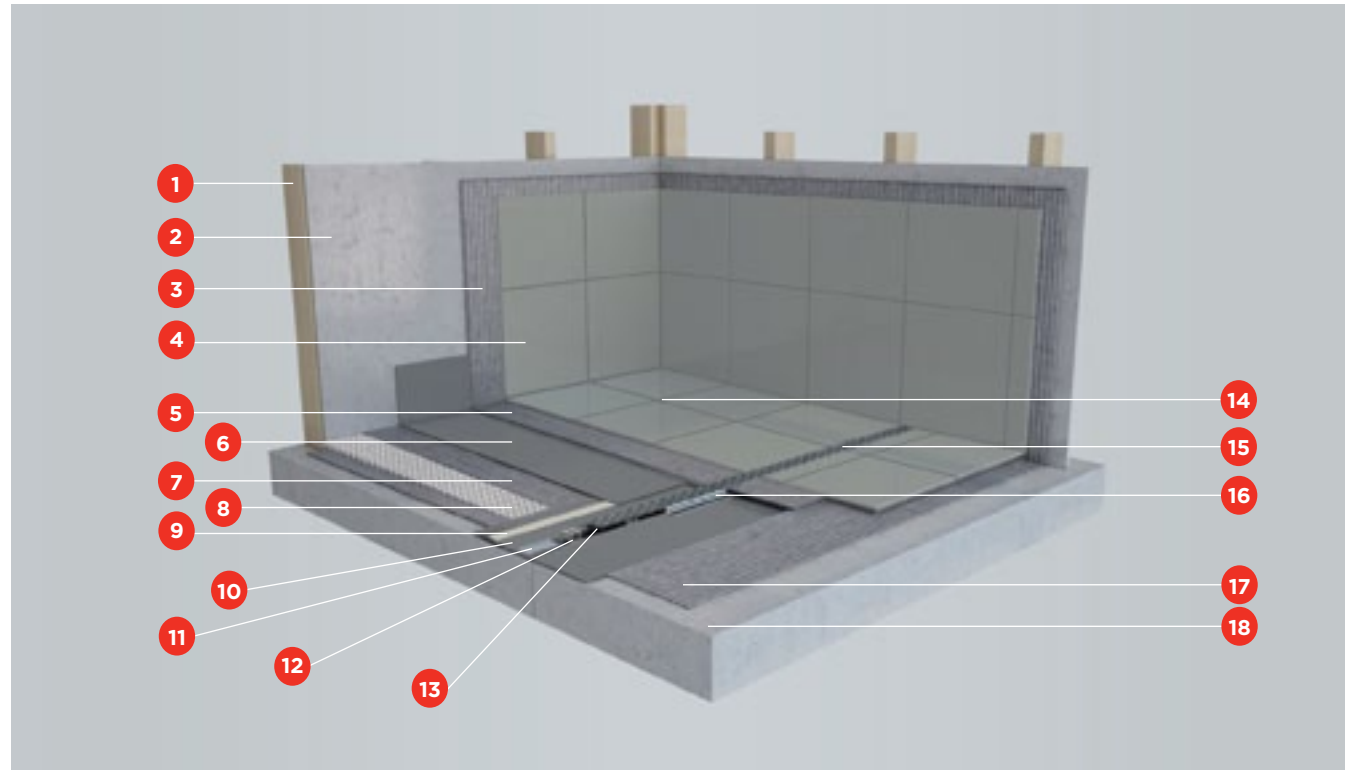

### WALL ASSEMBLY

- 1 Stud Wall
- 2 Backer Board
- 3 Thinset
- 4 Wall Tile

### FLOOR ASSEMBLY

- 5 Thinset
- 6 Waterproofing Membrane (pan liner)
- 7 Thinset
- 8 Quick Slope (2% Slope)
- 9 QuickSeal Membrane Adhesive Tape
- 10 Waterproof Membrane
- 11 Trough Extension
- 12 Spacer
- 13 Drain Body
- 14 Floor Tile
- 15 Drain Cover
- 16 Tile Edging
- 17 Thinset
- 18 Subfloor

## CRITICAL INSTALLATION TIPS

The biggest benefit of using a linear drain system is the elimination of a compound slope in the floor surface. With a linear drain, the slope is a single plane in the same direction and not in multiple directions. This single slope allows for simple and fast installation of large tiles or even slabs on the shower floor.

When installing a QuickDrain system at the shower entrance, be sure the drain cover runs the entire length of the shower. The rough opening from backer board to backer board will determine the size of the drain. When QuickDrain is installed at the wall-floor joint, attention has to be paid to the distance of the center of the waste outlet to the framing. To achieve a flawless installation at the wall, it is critical that the wall tile finishes 7/8" from the centerline of the drain. This ensures there are no slivers of tile needed between the drain cover and the back wall.

On 30, 36, 40, 44, 48, 52 and 57" drain models, the waste outlet is located three inches off-center from the drain to avoid joists, beams and other in-floor obstacles. On 26, 27-1/2, 46, 63 and 68" drain models, the waste outlet is located in the center of the drain.

*When unsure of drain sizes, placement and installation condition, please call our technical support at 970.668.0805 opt# 5 (residential use) or ext# 306 (commercial use)*

### SPACERS

QuickDrain is the only channel drain manufacturer that allows you to use spacers to easily set or raise the drain cover to the floor level.

Spacers are devices that are used to set the correct distance between the drain flange and the top of the drain cover. This is the same distance as the space between the waterproofing and the top of the finished flooring material in the shower pan installation. This includes the following layers: waterproofing membrane, mortar bed (if used), thinset and finish tile or stone. Integral waterproofing comes factory attached to the drain body.

A packet of spacers is included with each cover. Spacers are easily stacked in 1/8" increments, allowing you to achieve the height you need-up to 7/8". If the desired height is more than 7/8", custom spacers will be needed.

NOTE: Spacers are not used with our Resinous Flooring Drains. These use a custom cover that match the height of the finished flooring. Resinous drain covers are 3/16" tall to match the stainless steel frame around the trough.

## DRAIN PLACEMENT - ACCESSIBLE SHOWERS

If a wheelchair-accessible shower is required or desired, QuickDrain must be placed parallel to the shower entry. This is the only option for a true accessible shower pan because the shower floor is a single flat surface allowing a wheelchair to be completely stable. The slope rate and direction will stay constant (perpendicular to the length of the drain).



*ProLine Drain at the entry opposite to the highest point.*



*ProLine Drain at the back of the shower.*

## DRAIN PLACEMENT - ACCESSIBILITY IS NOT REQUIRED



*ProLine Drain at the wall opposite to the shower entry.*



*ProLine Drain at the shower entry right behind the curb.*



*ProLine Drain at the entry to the shower.*



**DO NOT DO THIS!** This is not an acceptable shower design for an accessible shower. There will be a height difference between the shower floor and the rest of the bathroom floor.



*ProLine Drain at the shower center.*



*ProLine Drain at the side wall. Usually done when replacing a standard tub, because there is no need to move waste plumbing.*



## DRAIN INSTALLATION DETAILS

These notes are applicable to pages 18 through 23:

Set all Quick Slope and Flat Panel on structurally sound, flat subfloor with fast-setting, self-curing thinset.

Set the drain body level. Do not follow subfloor if it is out of level.

TileIn cover not suitable for use at the entry nor other traffic areas.

5gpm is the maximum recommended water flow for a drain installed at the entry to a curbless shower.

Do not grout in cover. Cover must remain removable for maintenance.

Use proper reinforcing framing techniques when recessing drain into wood subfloor.

## DRAIN INSTALLATION DETAILS

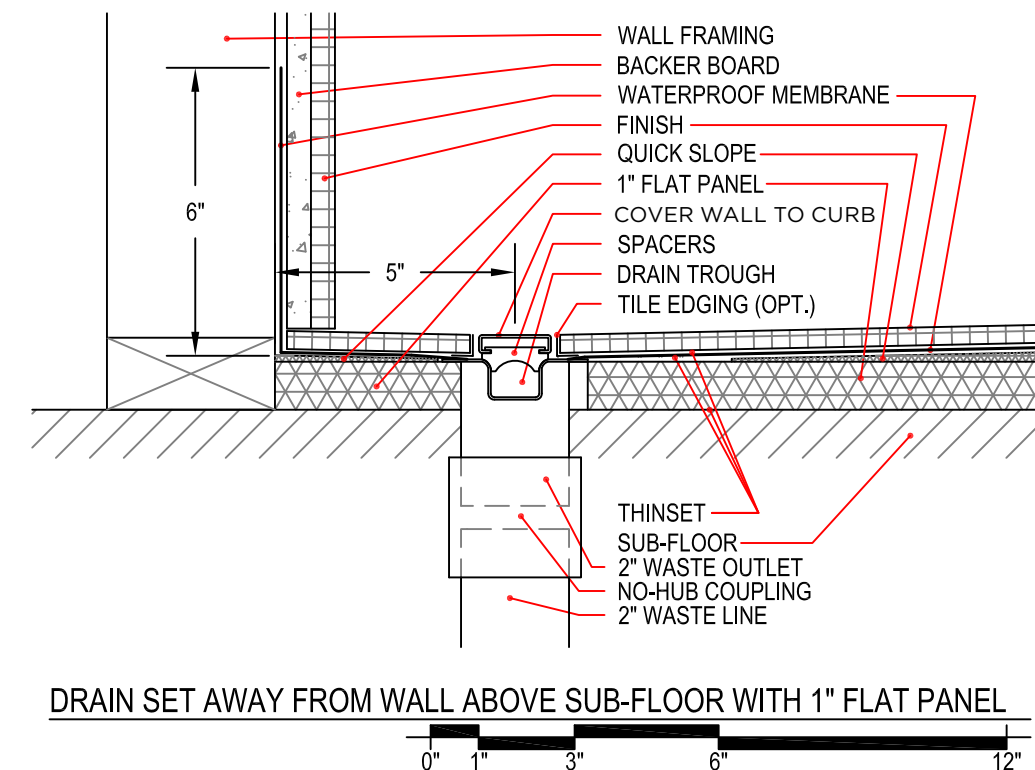
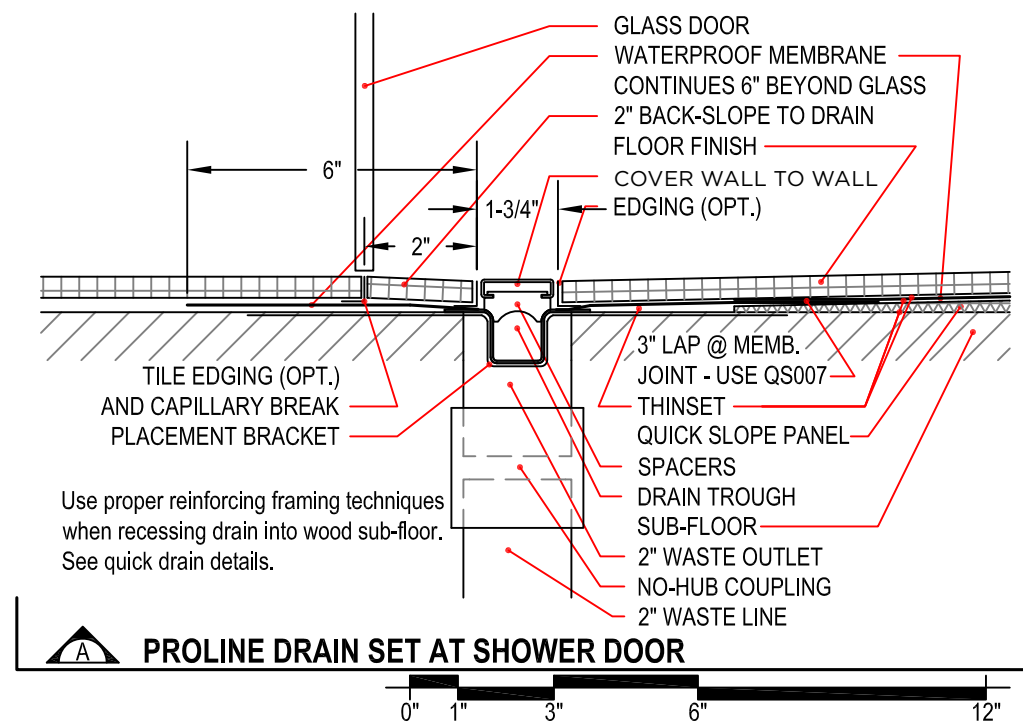
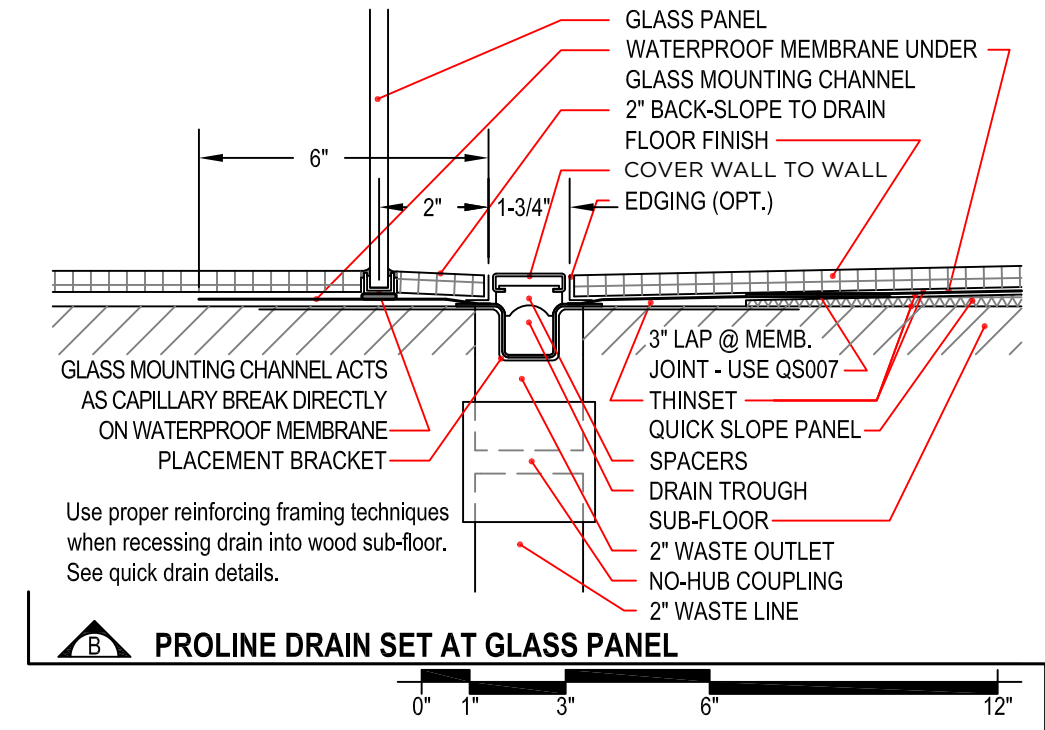

## DRAIN INSTALLATION DETAILS

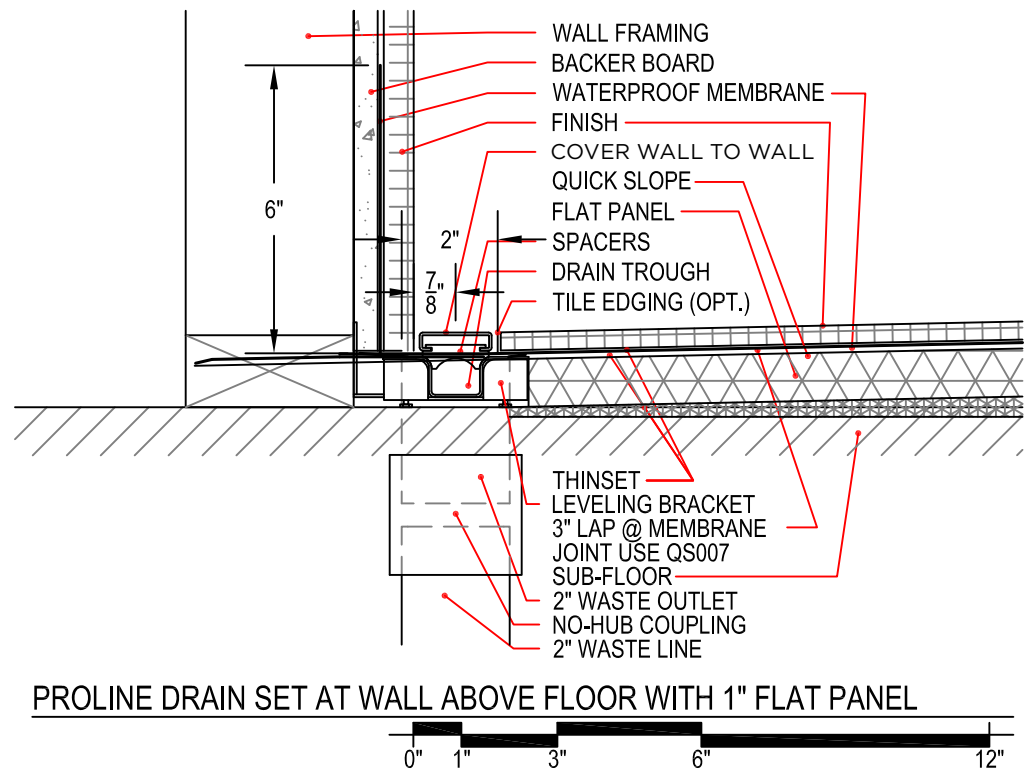
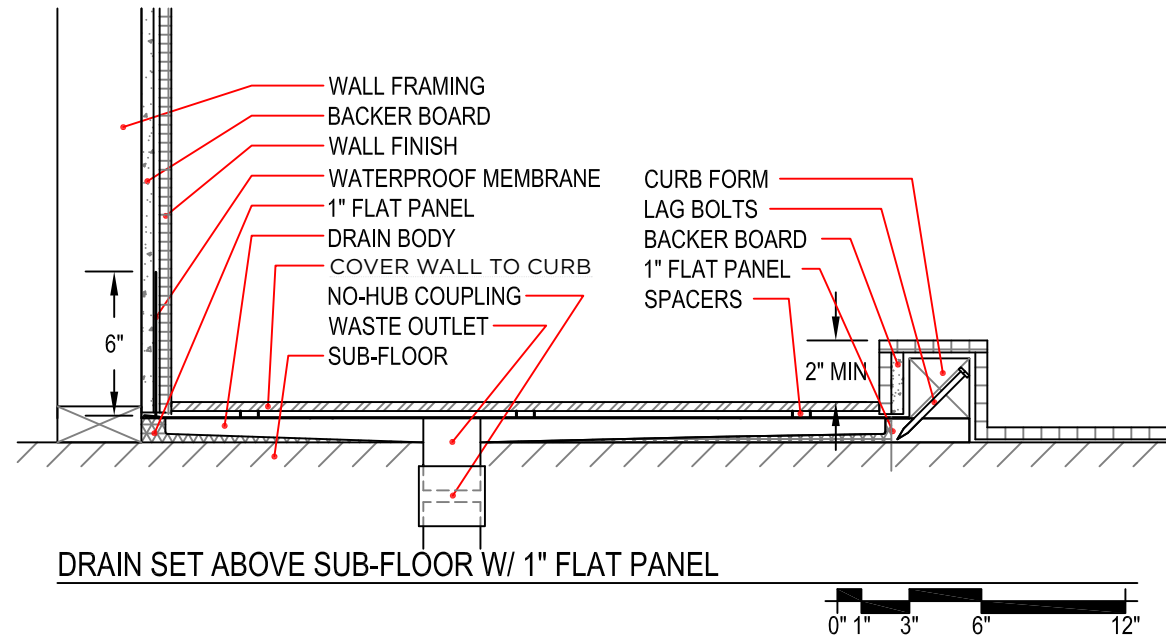

## DRAIN INSTALLATION DETAILS

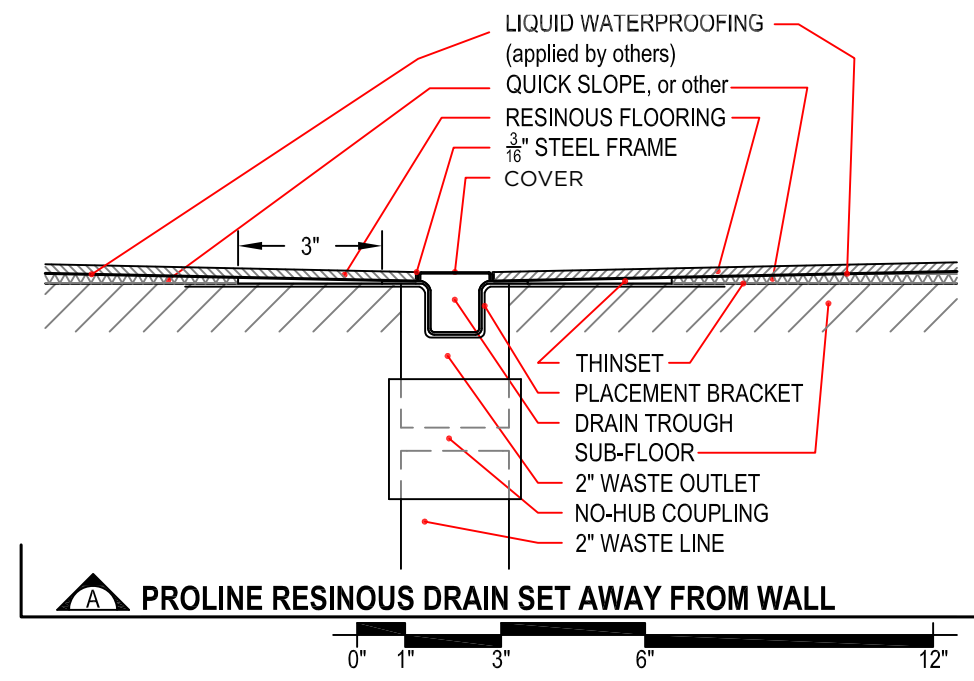
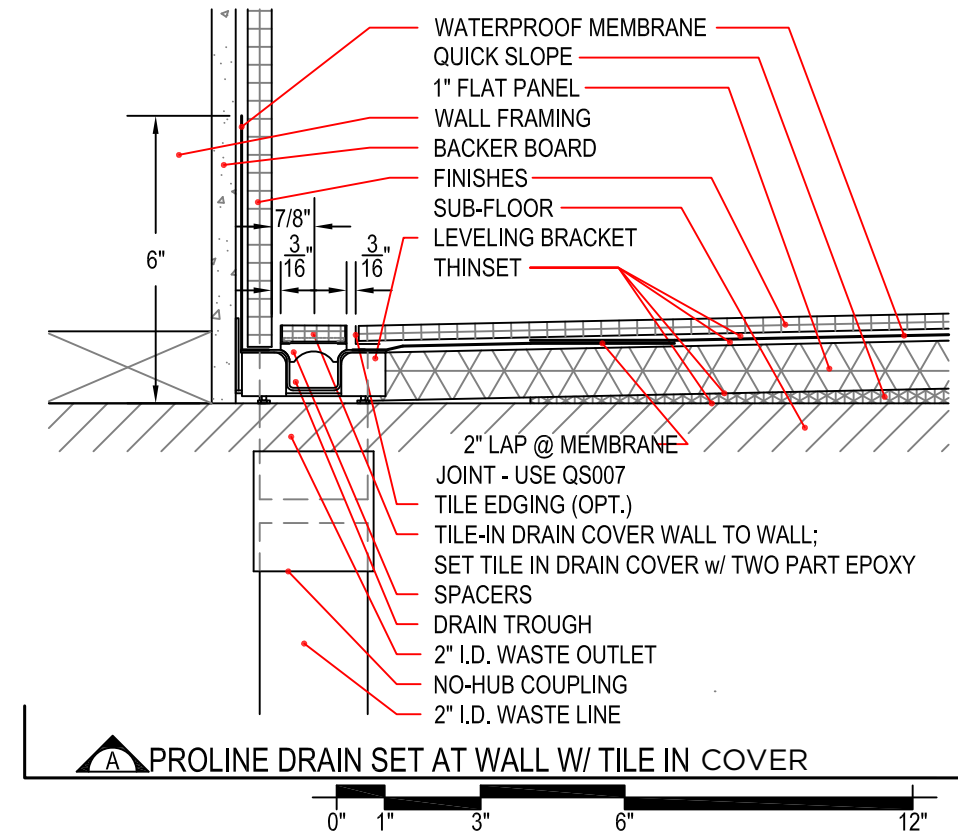



## DRAIN INSTALLATION DETAILS

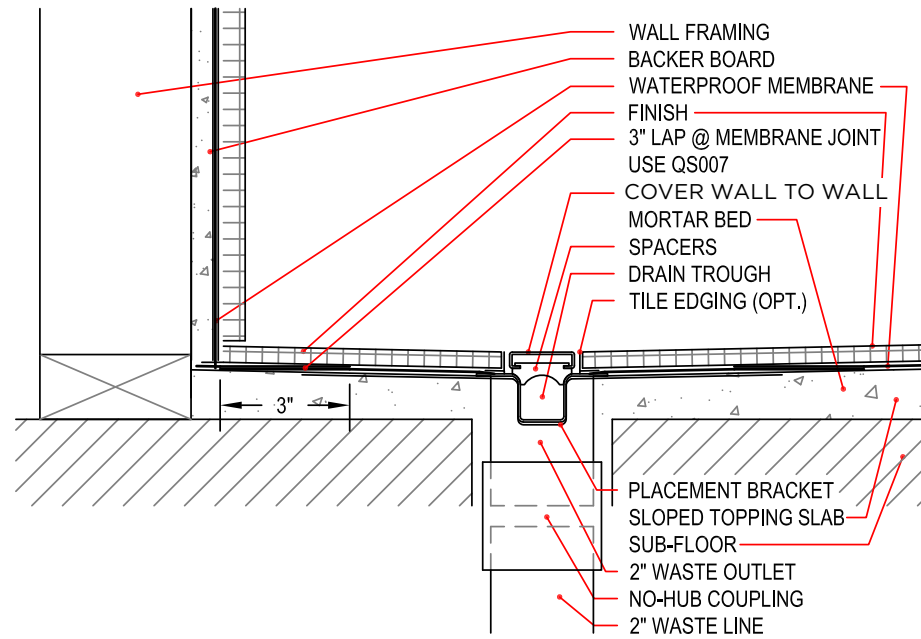

PROLINE DRAIN SET ABOVE FLOOR WITH CONCRETE PRE-SLOPE

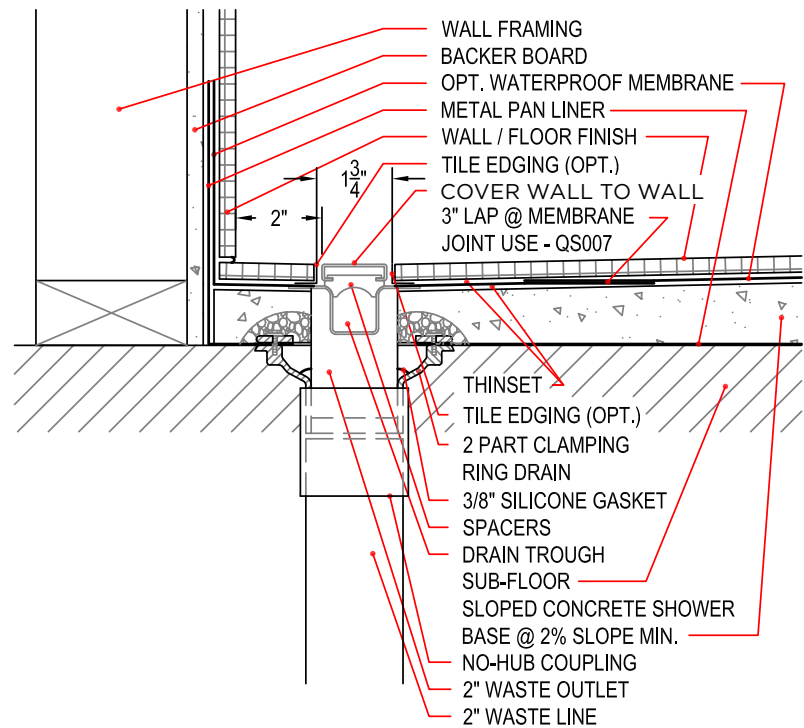
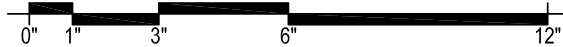

PROLINE DRAIN SET AT WALL WITH METAL PAN LINER

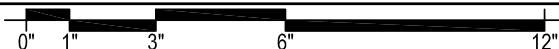

## INSTALLATION DETAIL - LINKING MULTIPLE DRAINS

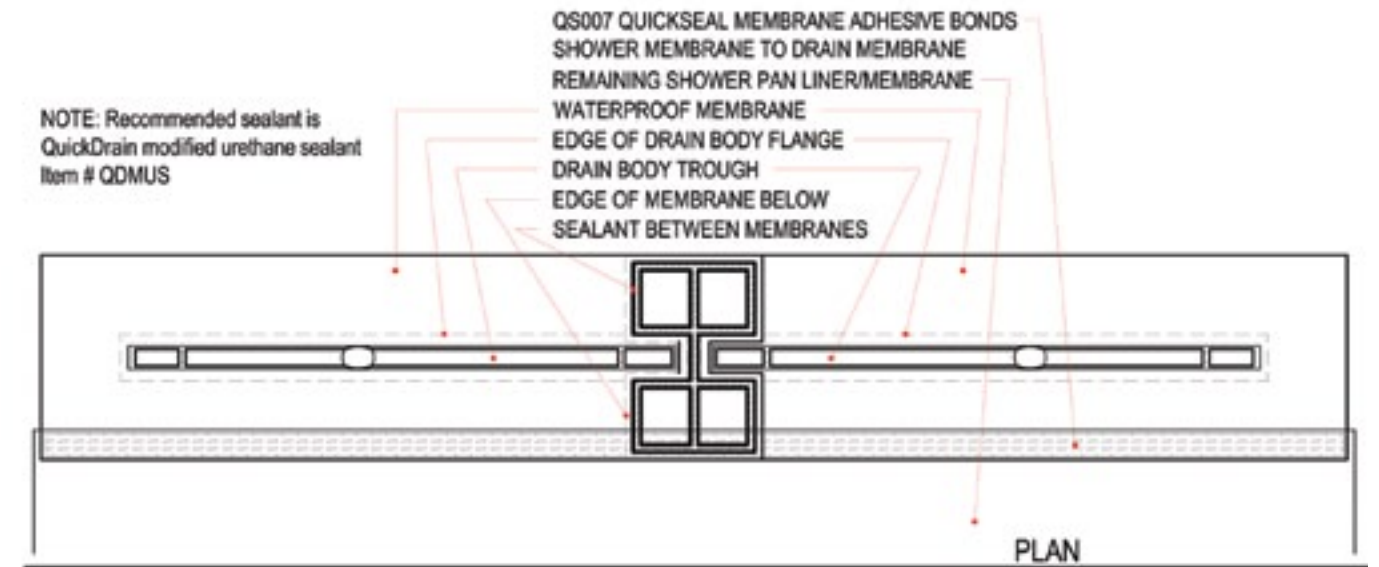

Note: In-Line Cover Connector is  
 4-1/2" long and can be cut down to  
 accommodate overall finish dimension.  
 Can be used with COSMO cover.

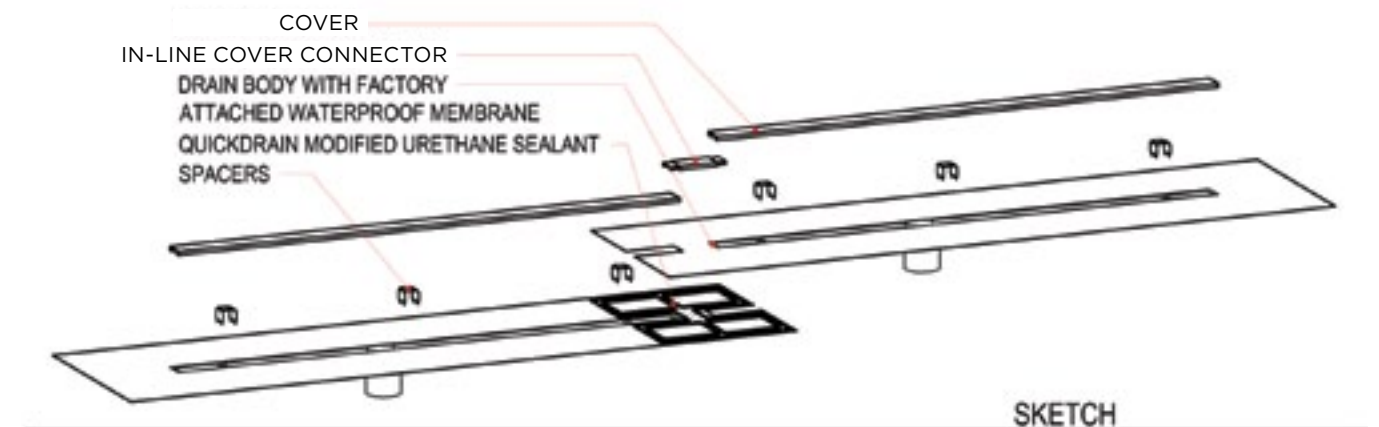
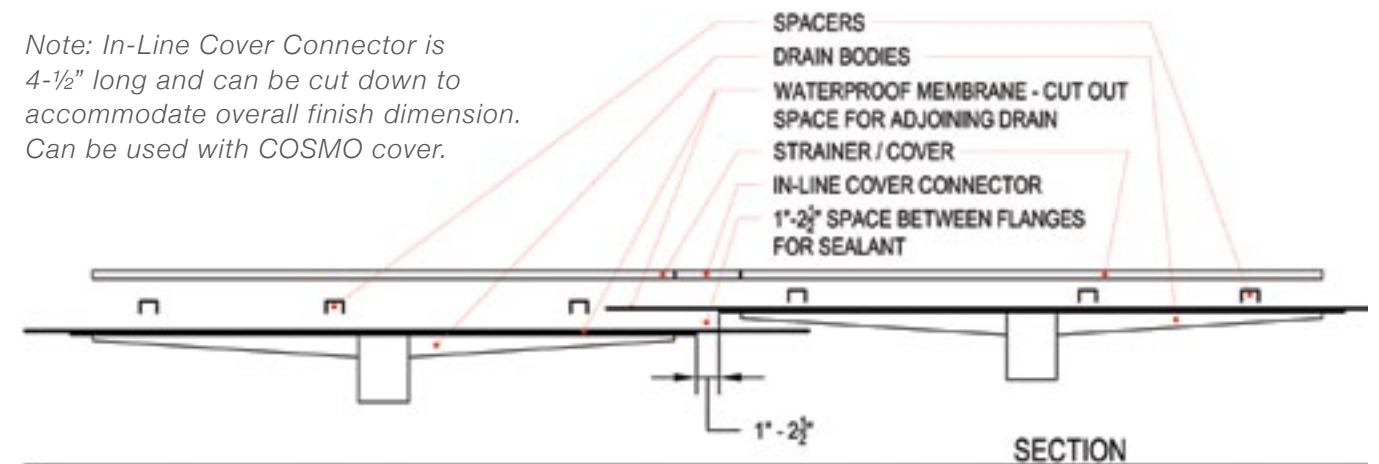

# EASY ORDER GUIDE

## DRAIN ASSEMBLY

### 1. Select the Drain Size

ITEM#	DIMENSIONS: R.O. = ROUGH OPENING = BACKER BOARD TO BACKER BOARD
PLD26	26" TROUGH LENGTH, 28" TOTAL LENGTH. FITS R.O. 28.5"-32"
PLD27.5	27.5" TROUGH LENGTH, 29.5" TOTAL LENGTH. FITS R.O. 30"-32.5"
PLD30	30" TROUGH LENGTH, 32" TOTAL LENGTH. FITS R.O. 32.5"-38"
PLD36	36" TROUGH LENGTH, 38" TOTAL LENGTH. FITS R.O. 38.5"-42"
PLD40	40" TROUGH LENGTH, 42" TOTAL LENGTH. FITS R.O. 42.5"-46"
PLD44	44" TROUGH LENGTH, 46" TOTAL LENGTH. FITS R.O. 46.5"-50"
PLD46	46" TROUGH LENGTH, 48" TOTAL LENGTH. FITS R.O. 48.5"-52"
PLD48	48" TROUGH LENGTH, 50" TOTAL LENGTH. FITS R.O. 50.5"-54"
PLD52	52" TROUGH LENGTH, 54" TOTAL LENGTH. FITS R.O. 54.5"-59.5"
PLD57	57" TROUGH LENGTH, 59" TOTAL LENGTH. FITS R.O. 59.5"-65"
PLD63	63" TROUGH LENGTH, 65" TOTAL LENGTH. FITS R.O. 65.5"-70"
PLD68	68" TROUGH LENGTH, 70" TOTAL LENGTH. FITS R.O. 70.5"-74"

Select the drain size closest to, but not longer than shower width, backer board to backer board, at drain location.

For a curbed shower, drain can be placed at any wall or medial location.

For a curbless shower, drain must be placed parallel to the entry.

When used at the entry to a curbless shower as a primary shower drain, the capacity of the drain is 5 gpm per waste outlet.

Custom lengths from 10"-100" and custom waste outlet configurations are available.

Custom drains require 3-4 weeks lead time, quote and signed-off drawing.

Drain body **cannot** be cut to size or modified on site.

*Refer to current price schedule for costs.*

*See website for additional products, cut sheets, installation details and instructions.*

*Call technical services for any product or installation questions: 970.668.0805 opt#5 (residential) or ext#306 (commercial).*

*Call customer service or sales for ordering assistance: 970.668.0805 opt#1 or opt#2.*

### 2. Select a Drain Cover Pattern, Size & Finish\*

LENGTH	ITEM #			
	STREAM	COSMO	LINES	TILEIN
28	STREAM28	COSMO28	LINES28	TILEIN28
30	STREAM30	COSMO30	LINES30	TILEIN30
36	STREAM36	COSMO36	LINES36	TILEIN36
40	STREAM40	COSMO40	LINES40	TILEIN40
44	STREAM44	COSMO44	LINES44	TILEIN44
46	STREAM46	COSMO46	LINES46	TILEIN46
48	STREAM48	COSMO48	LINES48	TILEIN48
52	STREAM52	COSMO52	LINES52	TILEIN52
58	STREAM58	COSMO58	LINES58	TILEIN58
63	STREAM63	COSMO63	LINES63	TILEIN63
68	STREAM68	COSMO68	LINES68	TILEIN68

\*Available finishes: STREAM - brushed & oil-rubbed bronze; COSMO - brushed, polished & oil-rubbed bronze; LINES - brushed & oil-rubbed bronze; TILEIN - insert your own tile.

See price schedule for cost and item numbers.

COSMO & TILEIN: Custom lengths from 10"-120" are available with additional production time.

STREAM & LINES: Custom lengths from 10"-70" are available with additional production time.

QuickDrain recommends the cover extend the entire length of the shower. Wall to wall or wall to curb.

Cover length can be up to 6" longer than drain trough and can be trimmed on site for a perfect fit.

When selecting a cover that is longer than the drain size, a trough extension (EX4SS) is used to extend the channel to the wall(s).

### Spacers - Setting the Cover Height

A packet of spacers is included with each cover. Spacers are easily stacked in 1/8" increments allowing you to achieve the height you need, up to 7/8". If the desired height is more than 7/8", **custom spacers will be needed.**

DESIGN/LENGTH	QUANTITY OF SPACERS PROVIDED										
	28	30	36	40	44	46	48	52	58	63	68
STREAM	3	3	3	4	4	4	4	5	5	6	6
COSMO	3	3	3	4	4	4	4	5	5	6	6
LINES	3	3	3	4	4	4	4	5	5	6	6
TILEIN	4	4	5	4	5	5	5	5	6	6	6

Spacers are used to attach the cover to the drain body and set the correct distance from the drain body flange to the top of the drain cover. This is the same distance as the complete floor finish from waterproofing to top of finish, including setting bed.



# EASY ORDER GUIDE

## QUICKDRAIN SHOWER PAN SYSTEM

### 1. QuickLiner Waterproof Membrane - Shower Pan Liner

More waterproof membrane is needed to complete the shower pan. This will be adhered to the 6" of membrane that comes attached to the drain body.

QuickDrain offers two widths, 39" wide (QTS39) and 78" wide (QTS78). Membrane is ordered by the linear foot.

Based on the length and width of the shower pan, order enough waterproof membrane to cover the shower floor, a 3" overlap onto the drain membrane and go up the walls at least 6".

ITEM#	SIZE	LINEAR QTY
QTS39	39" WIDE	
QTS78	78" WIDE	

### 2. QS007 QuickSeal Membrane Adhesive and QDMUS

Use the QuickSeal membrane adhesive (QS007) to bond drain body membrane to shower floor membrane.

Each roll is 118" long and 1-1/2" wide.

Use the QuickDrain modified urethane sealant (QDMUS) for installing corners, curb covers and capillarity breaks. May also be used to seal additional membrane.

ITEM#	SIZE	QTY
QS007	1.5" WIDE X 118" LONG	
QDMUS	10 OZ TUBE	

### 3. Placement Brackets & Leveling Brackets

ITEM#	SIZE	QTY
PLBSS	METAL SADDLE FOR DRAIN BODY SET INTO RECESSED INTO THE SUBFLOOR	
LVBSS	METAL SADDLE FOR DRAIN BODY SET ABOVE SUBFLOOR UP TO 3" FROM WALL	
LVBSL	METAL SADDLE FOR DRAIN BODY SET ABOVE SUBFLOOR 3" TO 6" FROM WALL	

Placement & leveling brackets will hold the drain in place during shower pan construction.

Placement brackets are used when the drain body is recessed into the subfloor.

Leveling brackets are used when the drain body is placed 1" or more above the subfloor and at a wall.

**When used, two brackets per drain body are required.**

### 4. Quick Slope and Flat Panel - pre-slope for any size/ shape shower in under 1 hour

ITEM#	SIZE	QTY
QS30P	30"X30" SINGLE SLOPED PANEL AT 2% (1/4" PER FOOT)	
FP30P	30"X30"X5/8" FLAT PANEL	
FP30P1	30"X30"X1" FLAT PANEL	

Quick Slope Panels (QS30P) are used to create slope to the drain. Dimensions: 30"x30" with a one-way 2% slope. Leading edge at the drain is 1/8" and trailing edge away from the drain is 3/4".

5/8" Flat Panels (FP30P) are used as a filler under Quick Slope Panels for sloping more than a 30" distance. Dimensions: 30"x30"x5/8".

1" Flat Panels (FP30P1) are used as a filler for the shower pan area when setting the drain body 1" above the subfloor. Dimensions: 30"x30"x1".

Quick Slope and Flat Panels are made of polypropylene honeycomb with a compression strength of 230 p.s.i.

Quick Slope Panels have a compression strength of over 2000 p.s.i. after filled with thinset.

Quick Slope and Flat Panels can be cut with a utility knife.

The QuickDrain sloping system can easily accommodate any size and shape shower pan. Single slope, perfectly flat pre-slope in under 1 hour.

### 5. Inside and Outside Corners & Curb Form and Curb Covers

Inside corners are pre-formed waterproofing membrane intended to hug 90° inside corners.

Outside corners are pre-formed waterproofing membrane intended to hug outside corners.

Curb forms are available in two sizes.

Curb covers are pre-formed waterproofing membrane intended to hug wall and curb joint.

ITEM#	SIZE	QTY
QTSIC	QUICKLINER INSIDE CORNER	
QTSOC	QUICKLINER OUTSIDE CORNER	
CURB3	2.5" X 3.5" X 61" CURB FORM	
CURB5	2.5" X 5" X 61" CURB FORM	
QTSCC	QUICKLINER CURB COVER	

*Refer to current price schedule for costs.*

*See website for additional products, cut sheets, installation details and instructions.*

*Call technical services for any product or installation questions: 970.668.0805 opt#5 (residential) or ext. 306 (commercial).*

*Call customer service or sales for ordering assistance: 970.668.0805 opt#1 or opt#2.*

# SUGGESTED MATERIALS FOR COMMON SHOWERS

## 28" X 58" CURBED TUB-TO-SHOWER CONVERSION



- 1-PLD26 Drain Body
- 1-COVER28 Cover (specify pattern)
- 3-SP Spacers
- 1-EX4SS Trough Extension
- 1-QS60SS 30"x60"x1/8"-1 3/8"
- 1-QS8PP 30"x8"x1/8"-3/8"
- 1-FP60P1 30"x60"x1" Flat Panel
- 1-CURB3 Curb Form
- 1-QS007 Membrane Adhesive Tape
- 4'-QTS78 48"x78" Waterproof Membrane
- 4-QTSIC Inside Corners
- 2-QTSCC Curb Covers
- 1-QDMUS Sealant

Note: This drain is recessed into subfloor and placed at the wall using the existing waste line from the pre-existing tub.

## 30" X 58" CURBLESS TUB-TO-SHOWER CONVERSION



- 1-PLD57 Drain Body
- 1-COVER58 Cover (specify pattern)
- 5-SP Spacers
- 2-PLBSS Placement Brackets
- 2-QS30P 30"x30" Quick Slope Panels
- 1-QS007 Membrane Adhesive Tape
- 6'-QTS39 72"x39" Waterproof Membrane
- 2-QTSIC Inside Corners
- 2-QTSOC Outside Corners
- 1-QDMUS Sealant

Note: This drain is recessed into subfloor and the existing waste line is relocated. When the drain is placed at the entry to a curbless shower as a primary drain, the capacity of the drain is 5 gpm per waste outlet.

## 44" X 96" SHOWER WITH EXISTING CENTERED WASTE LINE



- 1-PLD40 Drain Body
- 1-COVER44 Cover (specify pattern)
- 4-SP Spacers
- 4-EX4SS Trough Extension
- 5-FP30P1 30"x30"x1" Flat Panel
- 6-QS30P 30"x30" Quick Slope
- 2-FP30P 30"x30"x5/8" Flat Panel
- 2-CURB3 Curb Form
- 1-QS007 Membrane Adhesive Tape
- 10'-QTS78 120"x78" Waterproof Membrane
- 4-QTSIC Inside Cover
- 2-QTSCC Curb Covers
- 1-QDMUS Sealant

Note: This drain is placed above the subfloor using the existing waste line location.

## STEPS FOR PLANNING YOUR NEW SHOWER

Steps 8 through 10 apply when using our materials to create your shower pan.

### 1-Draw/sketch your bathroom and shower layout.

This should show all walls, corners and glass panels that will be in the finished shower area. Note the location of floor framing or any obstructions that may conflict with the waste outlet.

### 2- Curbed or curbless shower?

### 3- Decide on the drain location.

Be sure to consider how you are going to create slope to the drain.

-Back wall -Entry -Side Wall

Also decide if the drain will be recessed into the subfloor or set on top of subfloor. This will determine what brackets may be needed (placement or leveling).

### 4- Get measurements.

Be sure to NOTE if measurements are backer board to backer board (or framing to framing or even the desired finish size).

-Width (distance the drain will have to fit into)

-Depth (measured perpendicular to drain)

-If the drain is not against a wall or curb, measure from wall to centerline of drain.

### 5-Be sure to determine how many fixtures will be in the shower.

Find the GPM rating for each fixture.

This will help determine the total possible gallons per minute(gpm) which may be flowing into the drain.

-Example: 1 shower head (2.5 gpm) + 1 Rain head (3gpm)+ 2 body jets (2gpm ea) = 9.5gpm

Remember, curbless showers with the drain placed at the entry are rated at 5gpm per waste outlet.

Drains placed at the back wall or in a curbed shower will handle 10gpm per outlet.

It may be necessary to order a custom drain with multiple waste outlets to handle high water output.

### 6- Choose a drain that will fit between backer board to backer board or backer board to curb.

Use the longest drain that will fit and allow the waterproof membrane to turn up the face of the backer board.

Trough extensions are used to complete the stainless steel trough to wall. Trough extensions are 4" long and may be cut to length.

### 7- Choose a drain cover length that will fit from finished surface to finished surface.

Cover should be ordered slightly long and may be trimmed to length after shower is finished. If using material thicker than 3/4" for the floor, ask your salesperson for help in ordering special spacers.

### 8- Determine the amount of additional membrane which will be needed for the shower pan.

Remember the membrane should go 6" up the walls and over the curb (if needed). QS007 may be used to join additional membrane to the factory-attached membrane.

### 9- Count the number of inside corners, outside corners, and curb covers needed.

Be sure to order QDMUS sealant for installing corners and curb covers.

### 10- Plan what panels (Quick Slope and Flat panels) will be needed to create the 2% slope.

### 11- Create a list of all needed materials.

Your salesperson can review this and make suggestions.





**QUICKDRAINUSA.COM**

**866.998.6685**

**INFO@QUICKDRAINUSA.COM**

FAX: 866.357.8502

QUICKDRAIN USA

P.O.BOX 1358

FRISCO, CO 80443

MANUFACTURED IN THE USA