



SPACERS FOR “+” AND “T” SETTING LAYOUT

- R2 10 mm
- R2 9 mm
- R2 8 mm
- R2 7 mm
- R3 6 mm
- R3 5 mm
- R3 4 mm
- R4 3 mm
- R4 2 mm
- R4 1,5 mm
- R4 1 mm

SPACERS FOR OCTAGONAL TILES, “CASSETTONATO” AND LOZENGE, SPACERS FOR HEXAGONAL TILES, SPACERS FOR PROVINCIAL – “PROVENZALE”

- R5 SPACERS FOR OCTAGONAL TILES, “CASSETTONATO” AND LOZENGE
- R5 SPACERS FOR HEXAGONAL TILES
- R5 SPACERS FOR PROVINCIAL – “PROVENZALE”

WEDGES

- R5 BIG WEDGES
- R5 SMALL WEDGES

FLOATING FLOORS SUPPORTS

- R5 FLOATING FLOORS SUPPORTS

EXPANSION JOINTS AND PROFILES

- R6 EXPANSION JOINTS
- R6 PVC TRANSITION PROFILES

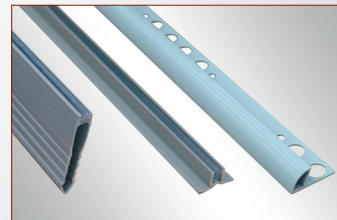
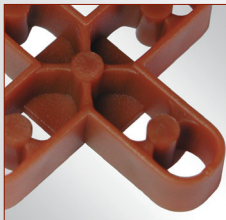

11 sizes (from 1 to 10 mm - 1/32” - 3/8”) in 37 different models: here is our range of spacers. A line of spacers for the professional which can choose versions with different heights, with holes for the passage of the adhesive, with fins for easy removal or to avoid the outcrop if installing with the traditional “mud-med” method, or even with the unique “Lego” system, which allows to fit a spacer over the other to get the desired

thickness. Of course, both for cross and “T” installation. In addition, three models (3 mm - 1/8” joint) for octagonal tile, “cassettonato”, lozenge, hexagonal tiles, “provenzale” tiles. To complete the offer, shimming wedges are available in two sizes, the largest with ergonomic grip design, large and knurled. Last but not least, expansion joints, profiles and floating floors supports.



SPACERS 10 mm - 3/8"

MADE IN ITALY!



193+1000		204+200	
S	A	B	H
10mm	40mm	40mm	7mm
3/8"	1 9/16"	1 9/16"	9/32"



204 R200			
S	A	B	H
10mm	50mm	50mm	13mm
3/8"	2"	2"	17/32"



193T1000		204T200	
S	A	B	H
10mm	40mm	25mm	7mm
3/8"	1 9/16"	1"	9/32"



204T200A			
S	A	B	H
10mm	50mm	30mm	13mm
3/8"	2"	1 3/16"	17/32"

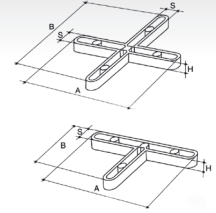

Part No.	Barcode	Type	Pieces	Box	Bag	Upright	Arch	Down	Flat	Up	Box	Box	Weight	Weight	
193+1000	8024648001306	+	1000	•	-	•	-	-	•	-	12	62x42xh 54 cm	24 3/8"x16 1/2"xh 21 1/4"	26,5 Kg	58.4 lbs
204+200	8024648001641	+	200	-	•	•	-	-	•	-	25	48x46xh 28 cm	18 7/8"x18 1/8"xh 11"	10,6 Kg	23.3 lbs
204R200	8024648001634	+	200	-	•	•	-	-	•	-	10	48x46xh 28 cm	18 7/8"x18 1/8"xh 11"	9,2 Kg	20.3 lbs
193T1000	8024648001313	+	1000	•	-	•	-	-	•	-	12	62x42xh 54 cm	24 3/8"x16 1/2"xh 21 1/4"	20,2 Kg	44.5 lbs
204T200	8024648001658	+	200	-	•	•	-	-	•	-	25	48x35xh 28 cm	18 7/8"x13 3/4"xh 11"	7,4 Kg	16.3 lbs
204T200A	8024648001665	+	200	-	•	•	-	-	•	-	10	48x35xh 28 cm	18 7/8"x13 3/4"xh 11"	6,6 Kg	14.5 lbs

SPACERS 9 mm - 11/32"



129+1000		128+200	
S	A	B	H
9mm	50mm	50mm	7mm
11/32"	2"	2"	9/32"



129T1000		128T200	
S	A	B	H
9mm	50mm	30mm	7mm
11/32"	2"	1 3/16"	9/32"

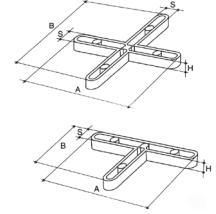

Part No.	Barcode	Type	Pieces	Box	Bag	Upright	Arch	Down	Flat	Up	Box	Box	Weight	Weight	
129+1000	8024648001337	+	1000	•	-	-	•	•	-	-	12	62x42xh 54 cm	24 3/8"x16 1/2"xh 21 1/4"	32,2 Kg	70.9 lbs
128+200	8024648001672	+	200	-	•	•	-	-	•	-	25	48x46xh 28 cm	18 7/8"x18 1/8"xh 11"	13,6 Kg	29.9 lbs
129T1000	8024648001344	+	1000	•	-	-	•	•	-	-	12	62x42xh 54 cm	24 3/8"x16 1/2"xh 21 1/4"	26,7 Kg	58.8 lbs
128T200	8024648001689	+	200	-	•	•	-	-	•	-	25	48x35xh 28 cm	18 7/8"x13 3/4"xh 11"	10,6 Kg	23.3 lbs

SPACERS 8 mm - 5/16"



372+1000		376+200	
S	A	B	H
8mm	40mm	40mm	7mm
5/16"	1 9/16"	1 9/16"	9/32"



372T1000		376T200	
S	A	B	H
8mm	40mm	25mm	7mm
5/16"	1 9/16"	1"	9/32"

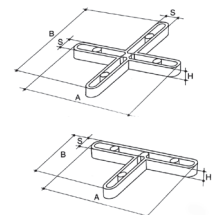

Part No.	Barcode	Type	Pieces	Box	Bag	Upright	Arch	Down	Flat	Up	Box	Box	Weight	Weight	
372+1000	8024648001351	+	1000	•	-	•	-	-	•	-	12	62x42xh 54 cm	24 3/8"x16 1/2"xh 21 1/4"	23,1 Kg	50.9 lbs
376+200	8024648001696	+	200	-	•	•	-	-	•	-	25	48x46xh 28 cm	18 7/8"x18 1/8"xh 11"	9,6 Kg	21.2 lbs
372T1000	8024648001368	+	1000	•	-	•	-	-	•	-	8	46x41xh 32 cm	18 1/8"x16 1/8"xh 12 5/8"	12,7 Kg	27.9 lbs
376T200	8024648001702	+	200	-	•	•	-	-	•	-	25	48x35xh 28 cm	18 7/8"x13 3/4"xh 11"	7,6 Kg	16.7 lbs

SPACERS 7 mm - 9/32"



152+1000E		151+200E	
S	A	B	H
7mm	40mm	40mm	7mm
9/32"	1 9/16"	1 9/16"	9/32"



152+1000L		151+200L	
S	A	B	H
7mm	40mm	40mm	5mm
9/32"	1 9/16"	1 9/16"	3/16"



152T1000E		151T200E	
S	A	B	H
7mm	40mm	25mm	7mm
9/32"	1 9/16"	1"	9/32"

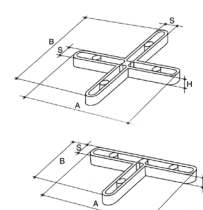

Part No.	Barcode	Type	Pieces	Box	Bag	Upright	Arch	Down	Flat	Up	Box	Box	Weight	Weight	
152+1000E	8024648001375	+	1000	•	-	•	-	-	•	-	12	62x42xh 54 cm	24 3/8"x16 1/2"xh 21 1/4"	26 Kg	57.3 lbs
151+200E	8024648001719	+	200	-	•	•	-	-	•	-	25	48x46xh 28 cm	18 7/8"x18 1/8"xh 11"	10,6 Kg	23.4 lbs
152+1000L	8024648001382	+	1000	•	-	•	-	-	•	-	16	62x42xh 45 cm	24 3/8"x16 1/2"xh 21 1/4"	18,4 Kg	40.5 lbs
151+200L	8024648001726	+	200	-	•	•	-	-	•	-	25	48x35xh 28 cm	18 7/8"x13 3/4"xh 11"	5,6 Kg	12.3 lbs
152T1000E	8024648001399	+	1000	•	-	•	-	-	•	-	8	46x41xh 32 cm	18 1/8"x16 1/8"xh 12 5/8"	13,3 Kg	29.3 lbs
151T200E	8024648001733	+	200	-	•	•	-	-	•	-	30	48x35xh 28 cm	18 7/8"x13 3/4"xh 11"	9,6 Kg	21.2 lbs

SPACERS, EXPANSION JOINTS AND PROFILES



SPACERS 6 mm - 1/4"

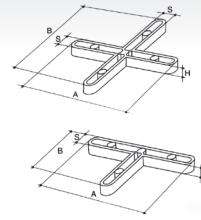

MADE IN ITALY

154+1000		153+200	
S	A	B	H
6mm	50mm	50mm	7mm
1/4"	2"	2"	9/32"

154+200		153T200	
S	A	B	H
6mm	50mm	28mm	7mm
1/4"	2"	1 7/64"	9/32"

Part No.	Barcode	Type	Pieces												
154+1000	8024648001405	+	1000	•	-	-	•	•	-	-	12	62x42xh 54 cm	24 3/8"x16 1/2"xh 21 1/4"	18,8 Kg	41.4 lbs
153+200	8024648001740	+	200	-	•	-	•	•	-	-	25	48x46xh 28 cm	18 7/8"x18 1/8"xh 11"	8,13 Kg	17.9 lbs
154T1000	8024648001412	+	1000	•	-	-	•	•	-	-	8	46x41xh 32 cm	18 1/8"x16 1/8"xh 12 5/8"	10,9 Kg	24lbs
153T200	8024648001757	+	200	-	•	-	•	•	-	-	30	48x35xh 28 cm	18 7/8"x13 3/4"xh 11"	8,1 Kg	17.8 lbs

SPACERS 5 mm - 3/16"

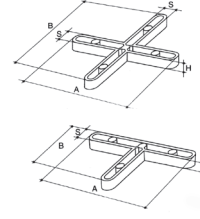

156+1000		155+200	
S	A	B	H
5mm	50mm	50mm	6mm
3/16"	2"	2"	1/4"

156+1000L		155+200L	
S	A	B	H
5mm	40mm	40mm	5mm
3/16"	1 9/16"	1 9/16"	3/16"

156R1000S		155R200	
S	A	B	H
5mm	50mm	50mm	6mm
3/16"	2"	2"	9/32"

156T1000		155T200	
S	A	B	H
5mm	35mm	28mm	6mm
3/16"	1 3/8"	1 7/64"	1/4"

156T1000E		155T200E	
S	A	B	H
5mm	35mm	28mm	6mm
3/16"	1 3/8"	1 7/64"	1/4"

Part No.	Barcode	Type	Pieces												
156+1000	8024648001450	+	1000	•	-	-	•	•	-	-	12	62x42xh 54 cm	24 3/8"x16 1/2"xh 21 1/4"	15 Kg	33 lbs
155+200	8024648001795	+	200	-	•	-	•	•	-	-	25	48x46xh 28 cm	18 7/8"x18 1/8"xh 11"	5,6 Kg	12.4 lbs
156+1000L	8024648001436	+	1000	•	-	-	-	-	•	-	16	62x42xh 45 cm	24 3/8"x16 1/2"xh 17 3/4"	16,8 Kg	37 lbs
155+200L	8024648001771	+	200	-	•	-	-	-	•	-	25	48x35xh 28 cm	18 7/8"x13 3/4"xh 11"	5,6 Kg	12.4 lbs
156R1000S	8024648008329	+	1000	-	•	-	•	•	-	•	10	62x42xh 45 cm	24 3/8"x16 1/2"xh 17 3/4"	13,8 Kg	30.4 lbs
155R200	8024648001764	+	200	-	•	-	•	•	-	•	20	48x46xh 28 cm	18 7/8"x18 1/8"xh 11"	6,6 Kg	14.5 lbs
156T1000	8024648001467	+	1000	•	-	-	•	•	-	-	8	46x41xh 32 cm	18 1/8"x16 1/8"xh 12 5/8"	8,1 Kg	17.8 lbs
155T200	8024648001801	+	200	-	•	-	•	•	-	-	30	48x35xh 28 cm	18 7/8"x13 3/4"xh 11"	6 Kg	13.2 lbs
156T1000E	8024648001443	+	1000	•	-	-	-	-	•	-	16	46x41xh 32 cm	18 1/8"x16 1/8"xh 12 5/8"	14,1 Kg	31 lbs
155T200E	8024648001788	+	200	-	•	-	-	-	•	-	40	32x32xh 28 cm	12 9/16"x12 9/16"xh 11"	6,8 Kg	15 lbs

SPACERS 4 mm - 5/32"

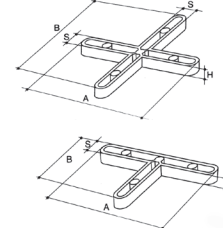

158+1000		157+200	
S	A	B	H
4mm	38mm	38mm	4mm
5/32"	1 31/64"	1 31/64"	5/32"

158R1000		157R200	
S	A	B	H
4mm	30mm	30mm	6mm
5/32"	1 3/16"	1 3/16"	1/4"

158T1000		157T200	
S	A	B	H
4mm	38mm	20mm	4mm
5/32"	1 31/64"	25/32"	5/32"

Part No.	Barcode	Type	Pieces												
158+1000	8024648001481	+	1000	•	-	-	-	-	•	-	24	62x42xh 45 cm	24 3/8"x16 1/2"xh 17 3/4"	20,7 Kg	45.5 lbs
157+200	8024648001825	+	200	-	•	-	-	-	•	-	50	48x35xh 28 cm	18 7/8"x13 3/4"xh 11"	8,6 Kg	18.9 lbs
158R1000	8024648008435	+	1000	•	-	-	-	-	•	-	16	62x42xh 45 cm	24 3/8"x16 1/2"xh 17 3/4"	22,4 Kg	49.3 lbs
157R200	8024648001818	+	200	-	•	-	-	-	•	-	25	32x32xh 28 cm	12 9/16"x12 9/16"xh 11"	6,9 Kg	15.2 lbs
158T1000	8024648001498	+	1000	•	-	-	-	-	•	-	16	46x41xh 32 cm	18 1/8"x16 1/8"xh 12 5/8"	10,1 Kg	22.3 lbs
157T200	8024648001832	+	200	-	•	-	-	-	•	-	40	32x32xh 28 cm	12 9/16"x12 9/16"xh 11"	5,2 Kg	11.5 lbs



SPACERS 3 mm - 1/8"

MADE IN ITALY!



160+1000		159+200	
S	A	B	H
3mm 1/8"	38mm 1 31/64"	38mm 1 31/64"	3,5mm 9/64"

160+1000E		159+200E	
S	A	B	H
3mm 1/8"	28mm 1 7/64"	28mm 1 7/64"	3mm 1/8"

160+T1000		159+T200	
S	A	B	H
3mm 1/8"	38mm 1 31/64"	38mm 1 31/64"	8mm 5/16"

160R1000		159R200	
S	A	B	H
3mm 1/8"	38mm 1 31/64"	38mm 1 31/64"	3,5mm 9/64"

160+1000A		159+200A	
S	A	B	H
3mm 1/8"	38mm 1 31/64"	38mm 1 31/64"	8mm 5/16"

160T1000		159T200	
S	A	B	H
3mm 1/8"	38mm 1 31/64"	20mm 25/32"	3,5mm 9/32"

Part No.	Barcode	Type	Pieces	Box	Roll	Upright	Arch	Down	Up	Box	Box	Weight
160+1000	8024648001528	+	1000	•	-	-	-	-	-	-	24	62x42x45 cm
159+200	8024648001863	+	200	-	-	-	-	-	-	-	50	48x35x28 cm
160+1000E	8024648001542	+	1000	•	-	-	-	-	-	-	32	42x42x40 cm
159+200E	8024648001887	+	200	-	-	-	-	-	-	-	60	32x32x28 cm
160+T1000	8024648008831	+	1000	•	-	-	-	-	-	-	16	62x42x45 cm
159+T200	8024648008534	+	200	-	-	-	-	-	-	-	30	48x35x28 cm
160R1000	8024648008572	+	1000	•	-	-	-	-	-	-	16	62x42x45 cm
159R200	8024648001856	+	200	-	-	-	-	-	-	-	40	48x35x28 cm
160+1000A	8024648005960	+	1000	•	-	-	-	-	-	-	16	62x42x45 cm
159+200A	8024648005977	+	200	-	-	-	-	-	-	-	30	48x35x28 cm
160T1000	8024648001535	+	1000	•	-	-	-	-	-	-	16	46x41x32 cm
159T200	8024648001870	+	200	-	-	-	-	-	-	-	40	32x32x28 cm

SPACERS 2 mm - 3/32"



133+1000		132+200	
S	A	B	H
2mm 3/32"	28mm 1 7/64"	28mm 1 7/64"	2,8mm 7/64"

133+1000A		132+200A	
S	A	B	H
2mm 3/32"	28mm 1 7/64"	28mm 1 7/64"	7mm 9/32"

133R1000		132R200	
S	A	B	H
2mm 3/32"	28mm 1 7/64"	28mm 1 7/64"	2,8mm 7/64"

133R1000A		132R200A	
S	A	B	H
2mm 3/32"	28mm 1 7/64"	28mm 1 7/64"	7mm 9/32"

133T1000		132T200	
S	A	B	H
2mm 3/32"	28mm 1 7/64"	16mm 5/8"	2,8mm 7/64"

Part No.	Barcode	Type	Pieces	Box	Roll	Upright	Arch	Down	Up	Box	Box	Weight
133+1000	8024648001566	+	1000	•	-	-	-	-	-	-	32	42x42x40 cm
132+200	8024648001900	+	200	-	-	-	-	-	-	-	50	32x32x28 cm
133+1000A	8024648008749	+	1000	•	-	-	-	-	-	-	16	46x41x32 cm
132+200A	8024648004604	+	200	-	-	-	-	-	-	-	30	32x32x28 cm
133R1000	8024648008671	+	1000	•	-	-	-	-	-	-	16	62x42x45 cm
132R200	8024648001894	+	200	-	-	-	-	-	-	-	40	32x32x28 cm
133R1000A	8024648014030	+	1000	•	-	-	-	-	-	-	16	62x42x45 cm
132R200A	8024648015365	+	200	-	-	-	-	-	-	-	30	32x32x28 cm
133T1000	8024648001573	+	1000	•	-	-	-	-	-	-	32	42x42x40 cm
132T200	8024648001917	+	200	-	-	-	-	-	-	-	50	32x32x28 cm
132T200A	8024648004611	+	200	-	-	-	-	-	-	-	40	32x32x28 cm

SPACERS 1,5 mm - 1/16"



131+1000		131+200	
S	A	B	H
1,5mm 1/16"	33mm 1 5/16"	33mm 1 5/16"	5mm 3/16"

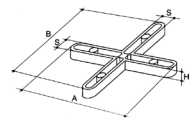

Part No.	Barcode	Type	Pieces	Box	Roll	Upright	Arch	Down	Up	Box	Box	Weight
131+1000	8024648060808	+	1000	•	-	-	-	-	-	-	16	62x42x45 cm
131+200	8024648060815	+	200	-	-	-	-	-	-	-	30	46x41x32 cm

SPACERS 1 mm - 1/32"



143+1000		143+200	
S	A	B	H
1mm 1/32"	28mm 1 7/64"	28mm 1 7/64"	3mm 1/8"

143T1000		143T200	
S	A	B	H
1mm 1/32"	32mm 1 3/16"	16mm 5/8"	4mm 5/32"

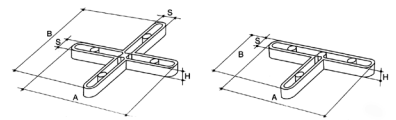

Part No.	Barcode	Type	Pieces	Box	Roll	Upright	Arch	Down	Up	Box	Box	Weight
143+1000	8024648004581	+	1000	•	-	-	-	-	-	-	32	42x42x40 cm
143+200	8024648004628	+	200	-	-	-	-	-	-	-	50	32x32x28 cm
143T1000	8024648017796	+	1000	•	-	-	-	-	-	-	32	42x42x40 cm
143T200	8024648017802	+	200	-	-	-	-	-	-	-	50	32x32x28 cm





163P1000		162P200	
S	A	B	H
-	28mm	10mm	6mm
-	1 7/64"	13/32"	1/4"



163G1000		162G200	
S	A	B	H
-	40mm	9mm	8mm
-	1 9/16"	11/32"	5/16"

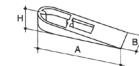

Part No.	Barcode	Type	Pieces	Box	Bag	Upright	Down	Left	Right	Up	Down	Box	Box	Weight	
163P1000	8024648001627	▲	1000	•	-	-	•	-	•	-	-	32	42x42xh40 cm	16 1/2"x16 1/2"xh 15 3/4"	18,2 Kg / 40.1 lbs
162P200	8024648001962	▲	200	-	•	-	•	-	•	-	-	50	32x32xh28 cm	12 9/16"x12 9/16"xh 11"	5,4 Kg / 11.9 lbs
163G1000	8024648001610	▲	1000	-	•	-	•	-	•	-	-	18	62x42xh45 cm	24 3/8"x16 1/2"xh 17 3/4"	20,5 Kg / 45.1 lbs
162G200	8024648001955	▲	200	-	•	-	•	-	•	-	-	25	32x32xh28 cm	12 9/16"x12 9/16"xh 11"	4,2 Kg / 9.3 lbs

SPACERS FOR OCTAGONAL TILES, "CASSETTONATO" AND LOZENGE (3 mm - 1/8")



161Y200			
S	A	B	H
3mm	-	-	6mm
1/8"	-	-	1/4"

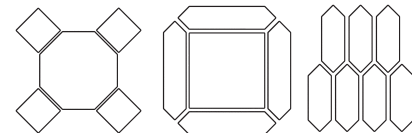

Part No.	Barcode	Type	Pieces	Box	Bag	Upright	Down	Left	Right	Up	Down	Box	Box	Weight	
161Y200	8024648001924	Y	200	-	•	-	•	-	•	-	-	40	32x32xh 28 cm	12 9/16"x12 9/16"xh 11"	3,6 Kg / 7.9 lbs

SPACERS FOR HEXAGONAL TILES (3 mm - 1/8")



161E200			
S	A	B	H
3mm	-	-	5mm
1/8"	-	-	6/16"

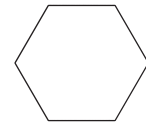

Part No.	Barcode	Type	Pieces	Box	Bag	Upright	Down	Left	Right	Up	Down	Box	Box	Weight	
161E200	8024648001931	Y	200	-	•	-	•	-	•	-	-	40	32x32xh 28 cm	12 9/16"x12 9/16"xh 11"	4,4 Kg / 9.7 lbs

SPACERS FOR PROVINCIAL - "PROVENZALE" (3 mm - 1/8")



161P200			
S	A	B	H
3mm	-	-	6mm
1/8"	-	-	1/4"



Part No.	Barcode	Type	Pieces	Box	Bag	Upright	Down	Left	Right	Up	Down	Box	Box	Weight	
161P200	8024648001948	T	200	-	•	-	•	-	•	-	-	40	32x32xh 28 cm	12 9/16"x12 9/16"xh 11"	4,4 Kg / 9.7 lbs

FLOATING FLOORS SUPPORTS



161P300		
S	O	H
4mm	150mm	6mm
19/16"	5 5/8"	11/16"

Part No.	Barcode	Type	Pieces	Box	Bag	Upright	Down	Left	Right	Up	Down	Box	Box	Weight	
312P300	8024648009845	⊙	-	-	-	-	-	-	-	-	-	300	65x45xh 45 cm	25 9/16"x17 3/4"xh 17 3/4"	27,4 Kg / 60.4 lbs



EXPANSION JOINTS AND PROFILES

MADE IN ITALY!

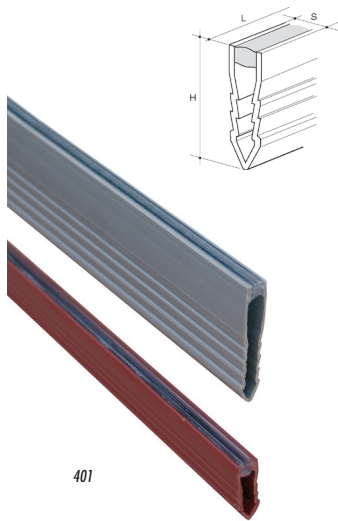

401

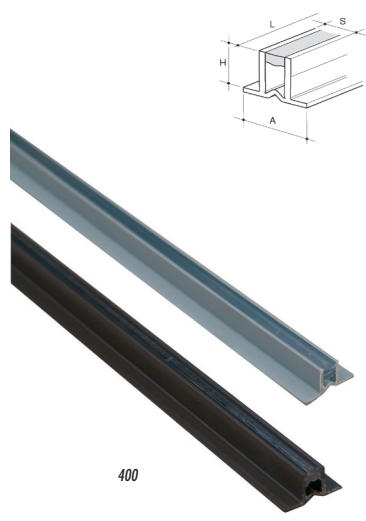

400



404/405/406

PACKAGE



CARTON BOX

EXPANSION JOINTS FOR THIN-SET ADHESIVE

Part No.	Barcode	Box Qty	Description	COLOR		S	H	Profile	Total Qty	Dimensions	Weight
				External	Internal						
400 7X8G	8024648001993	40	Raiflex joint	grey	clear	8 mm	7 mm	250 cm	100 m	254x12xh 9 cm	8,3 Kg
400 7X8M	8024648002044	40	Raiflex joint	brown	clear	5/16"	9/32"	8' 2 1/2"	328'	100"x4 3/4"xh 3 1/2"	18.3 lbs
400 9X8G	8024648002006	40	Raiflex joint	grey	clear	8 mm	9 mm	250 cm	100 m	254x12xh 9 cm	11,5 Kg
400 9X8M	8024648002051	40	Raiflex joint	brown	clear	5/16"	23/64"	8' 2 1/2"	328'	100"x4 3/4"xh 3 1/2"	25.3 lbs
400 11X8G	8024648002013	40	Raiflex joint	grey	clear	8 mm	11 mm	250 cm	100 m	254x13xh 9 cm	14,7 Kg
400 11X8M	8024648002068	40	Raiflex joint	brown	clear	5/16"	7/16"	8' 2 1/2"	328'	100"x5 1/16"xh 3 1/2"	32.4 lbs
400 13X8G	8024648002020	40	Raiflex joint	grey	clear	8 mm	13 mm	250 cm	100 m	254x13xh 9 cm	17,9 Kg
400 13X8M	8024648002075	40	Raiflex joint	brown	clear	5/16"	33/64"	8' 2 1/2"	328'	100"x5 1/16"xh 3 1/2"	39.4 lbs
400 15X8G	8024648002037	40	Raiflex joint	grey	clear	8 mm	15 mm	250 cm	100 m	254x13xh 9 cm	21.1 Kg
400 15X8M	8024648002082	40	Raiflex joint	brown	clear	5/16"	19/32"	8' 2 1/2"	328'	100"x5 1/16"xh 3 1/2"	6.5 lbs

EXPANSION JOINTS FOR MORTAR / MUD

Part No.	Barcode	Box Qty	Description	COLOR		S	H	Profile	Total Qty	Dimensions	Weight
				External	Internal						
401 23X8G	8024648002112	40	Raiflex joint	grey	clear	8 mm	25 mm	250 cm	100 m	254x12xh 9 cm	12,9 Kg
401 23X8R	8024648002174	40	Raiflex joint	red	clear	5/16"	31/32"	8' 2 1/2"	328'	100"x4 3/4"xh 3 1/2"	28.4 lbs
401 35X8G	8024648002105	40	Raiflex joint	grey	clear	8 mm	35 mm	250 cm	100 m	254x16xh 9 cm	22,5 Kg
401 35X8R	8024648002167	40	Raiflex joint	red	clear	5/16"	1 3/8"	8' 2 1/2"	328'	100"x6 1/4"xh 3 1/2"	49.6 lbs
401 45X8G	8024648002099	20	Raiflex joint	grey	clear	8 mm	45 mm	250 cm	50 m	254x16xh 9 cm	12,0 Kg
401 45X8R	8024648002150	20	Raiflex joint	red	clear	5/16"	1 3/4"	8' 2 1/2"	164'	100"x6 1/4"xh 3 1/2"	26.4 lbs

PVC TRANSITION PROFILES

Part No.	Barcode	Box Qty	Description	COLOR	H	Profile	Total Qty	Dimensions	Weight
404TRIM6G	8024648002310	100	Jolly PVC	grey	15/64"	8' 2 1/2"	820' 2 1/2"	100"x5 1/16"xh 3 1/2"	29.3 lbs
405TRIM8B	8024648002334	80	Jolly PVC	white	8 mm	250 cm	200 m	254x13xh 9 cm	13,9 Kg
405TRIM8G	8024648002341	80	Jolly PVC	grey	5/16"	8' 2 1/2"	656' 2"	100"x5 1/16"xh 3 1/2"	30.6 lbs
406TRIM10B	8024648002365	50	Jolly PVC	white	10 mm	250 cm	125 m	254x13xh 9 cm	10,8 Kg
406TRIM10G	8024648002372	50	Jolly PVC	grey	13/32"	8' 2 1/2"	410' 1 1/4"	100"x5 1/16"xh 3 1/2"	23.8 lbs

SPACERS, EXPANSION JOINTS AND PROFILES

