

ATENCIÓN
ATTENTION

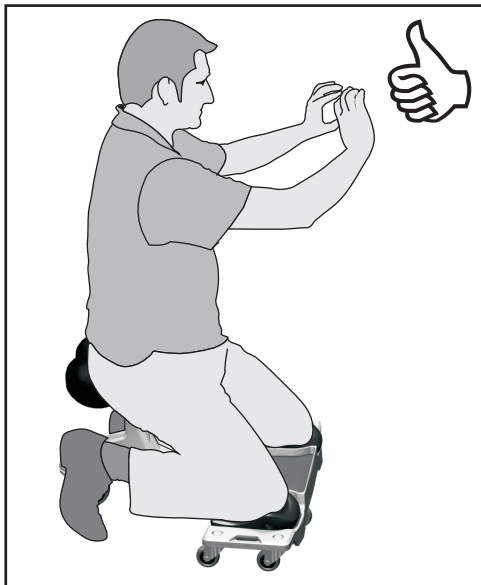

Ref:51032.V1

INSTRUCCIONES DE MONTAJE
ASSEMBLY INSTRUCTIONS

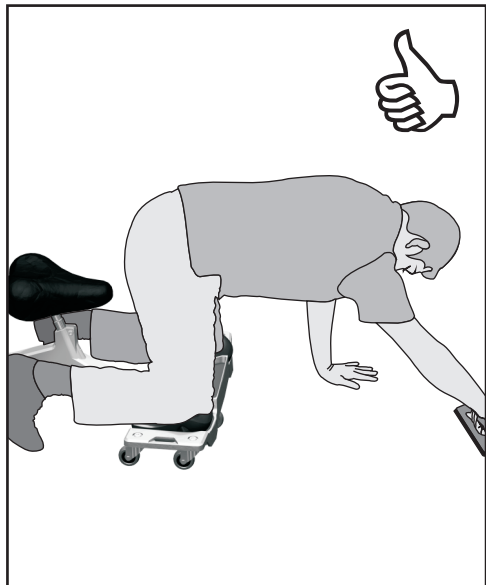
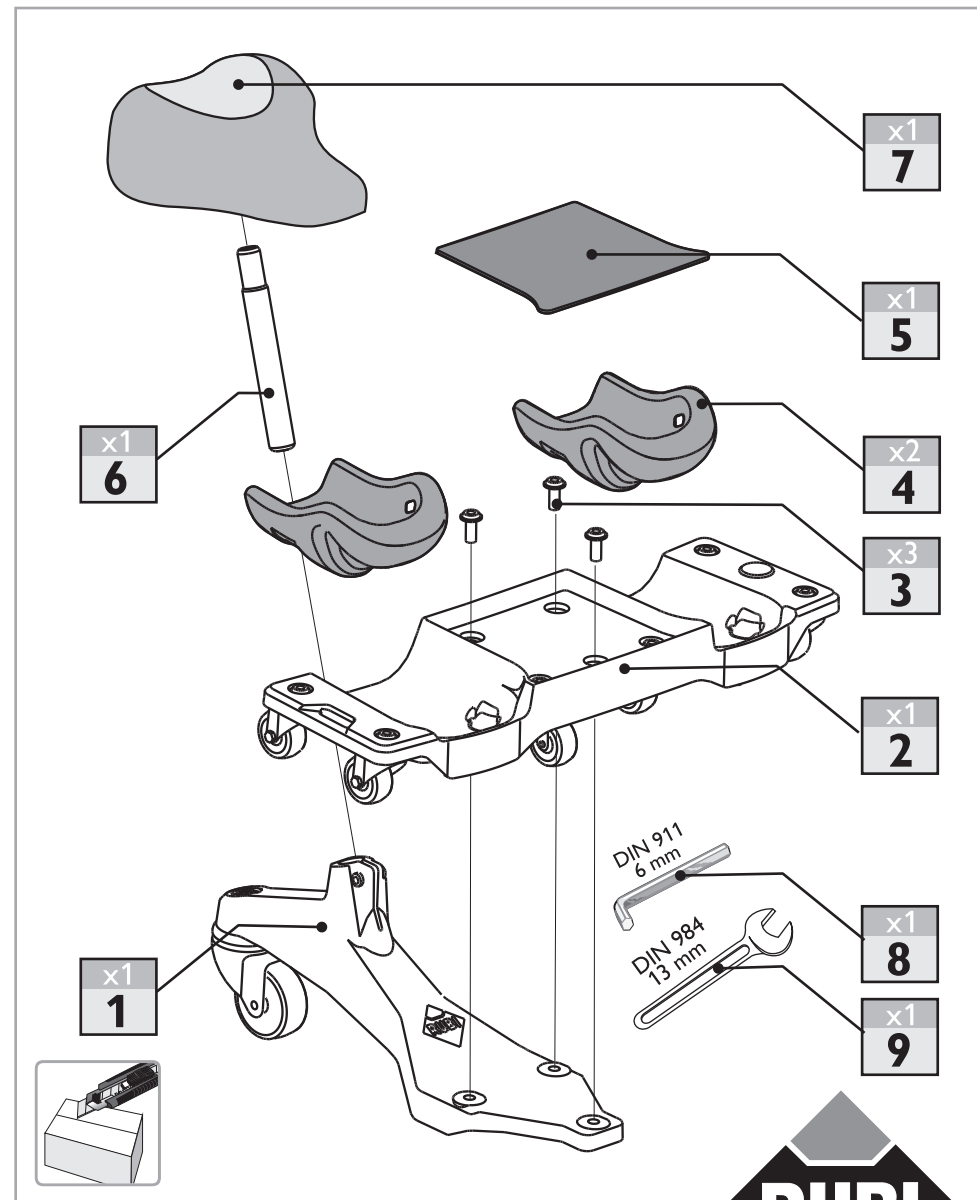

SR-1

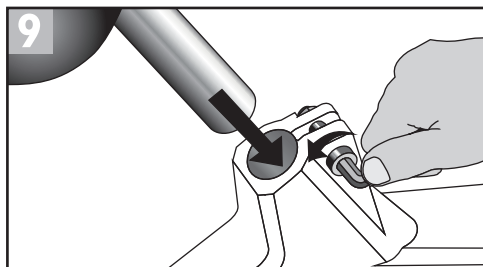
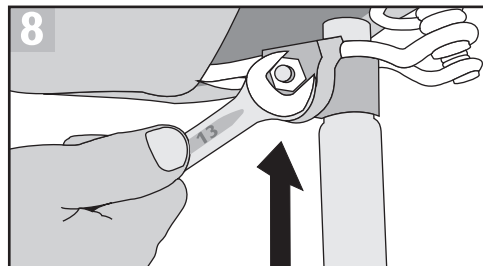
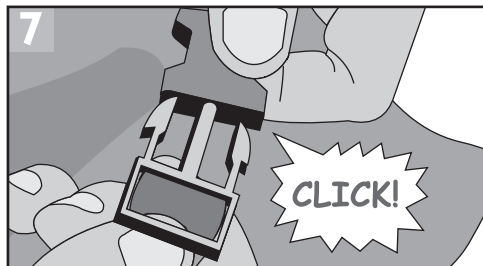
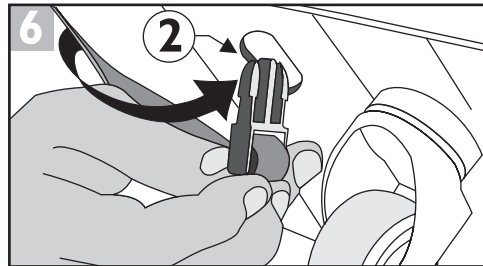
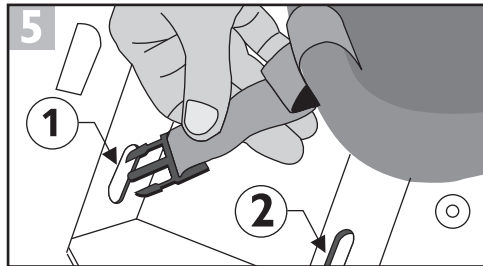
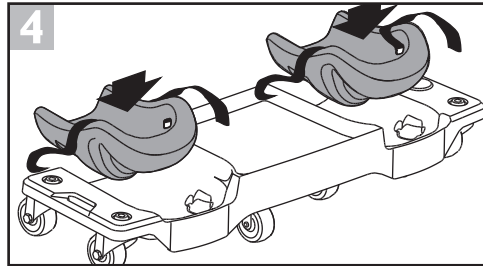
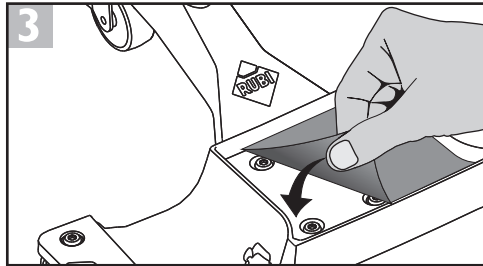
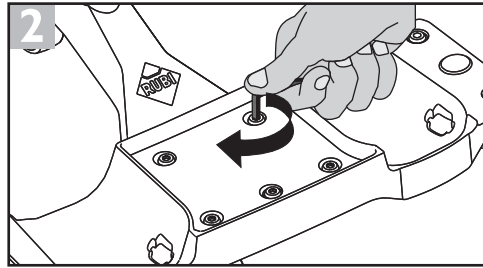
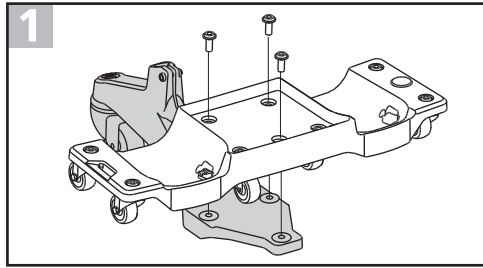

SR-1

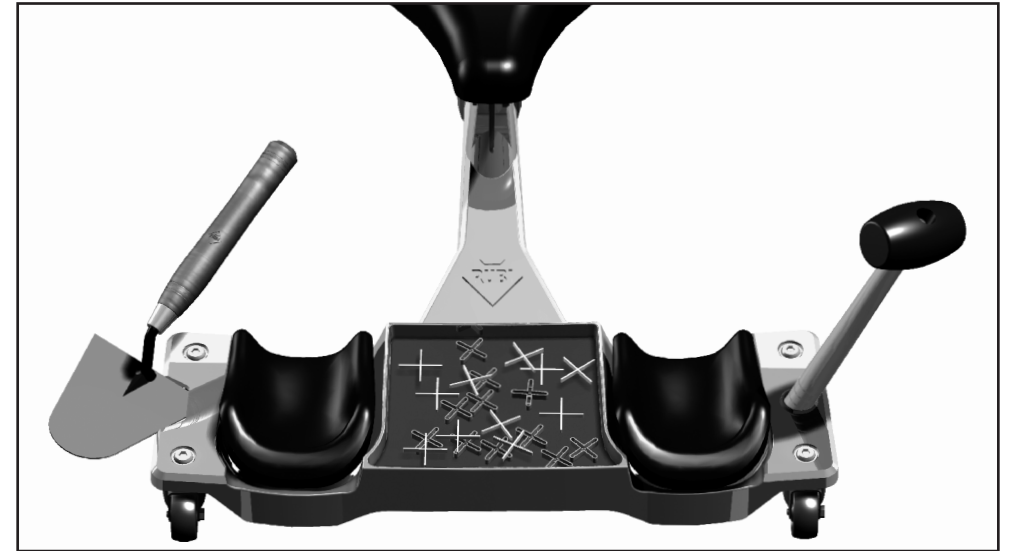

CARACTERÍSTICAS TÉCNICAS
TECHNICAL CHARACTERISTICS

Ref.				
Ref.81999	620x560x350 mm 24 1/2x22 1/8 x13 7/8 inch	Ref.65915	130 Kg • 286 Lb	7,5 Kg • 16,5 Lb

