



MARSHALLTOWN
The Premier Line



**OPERATIONS MANUAL
AND PARTS BOOK**

EDI-13261 PART# SW100H

Marshalltown, IA
Phone 800-888-0127 / 641-753-0127
Fax 800-477-6341 / 641-753-6341
www.MARSHALLTOWN.com
WS570



TABLE OF CONTENTS

Common Components	3
Assembly Instructions	4-6
Machine Adjustments	7
Parts Breakdown	8-9
Wet Screeding	10
Form to Form Screeding	11
Technical Data/Capacities	12
Maintenance Schedule	12
How to Operate	13-14
Warranty	15

This machine was built with user safety in mind, however, it can present hazards if improperly operated and serviced. Follow operating instructions carefully and use good judgement when operating!

If you have questions about operating or servicing this equipment, please contact your Marshalltown distributor or Marshalltown Company at 800-888-0127 or 641-753-0127.



COMMON COMPONENTS



1. Start/Stop Switch
2. Engine
3. Recoil Starter
4. Oil Cap
5. Gas Cap
6. Throttle Lever
7. Handle Bar Mounting Blocks
8. Handle Bars
9. Adjustable Hand Grips
10. Kickstand
11. Drive Shaft
12. Vibration Dampeners
13. Blade
14. Eccentric Weight Cover
15. Frame
16. Lifting Bar
17. Tachometer/Hour Meter
18. Board Mounting Plate
19. Throttle Cable
20. Air Filter

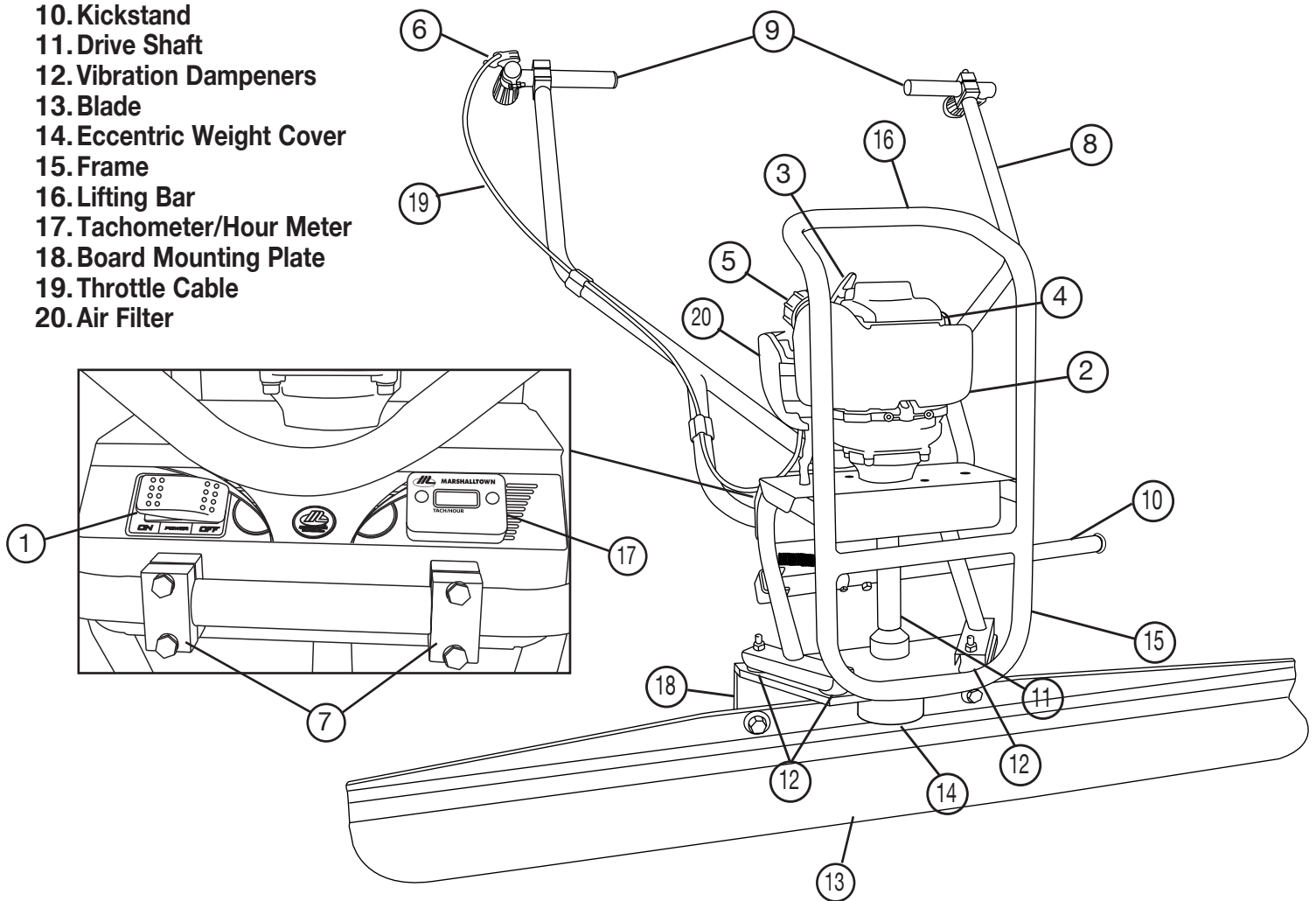



ASSEMBLY INSTRUCTIONS

Your Shockwave™ Screed power unit ships in two boxes, one containing the handle bars and the other containing the power unit. Assembly is easy, following these steps:

INSTALLING HANDLE BARS AND KICKSTAND:

Step 1 – Remove the 4 hex screws (A) that hold down the two handle mounting blocks.

Step 2 – Slide kickstand arm onto kickstand end and fasten with nut & bolt (B) as shown

Step 3 – Place handle bars into mounting blocks, making sure handle bars are centered evenly across the mounting blocks.

Step 4 – Making sure all mounting block and frame holes are aligned, insert hex screws and tighten with 7/16" wrench or socket.



ASSEMBLY INSTRUCTIONS



INSTALLING THROTTLE CABLE:



Step 1 – Remove carburetor cover by pressing clips.

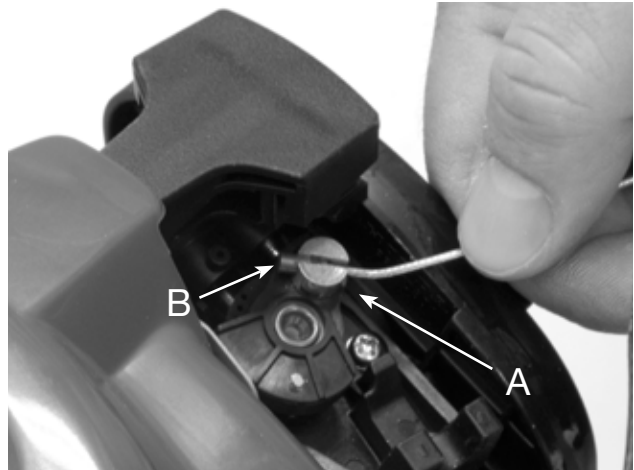

Step 2 – The throttle has a rotating silver peg (A) with a slot on one side of it. One end of the throttle cable has a metal barrel (B) that fits into this slot. Insert barrel into the slot so when the throttle cable is pulled, it will pull the throttle open (toward the base plate of the screed).



Step 3 – Fasten the throttle cable as shown. Make sure there is a nut on each side of plastic fitting. Make sure the cable does not work itself out of the plastic fitting while tightening.



Step 4 – Attach the throttle lever to the “T” grip handle, as shown above.

ASSEMBLY INSTRUCTIONS



Step 5 – Thread the exposed metal end of the throttle cable into the throttle lever. The lever will need to be “opened” to expose the hole it fits into. Back out the set screw to allow the cable to pass through.



Step 6 - Once cable is through throttle lever, return the lever to the “idle” position shown above. Using pliers, pull all extra slack out of the cable, making sure you are not actually opening the throttle at the carburetor. Once all slack is removed, tighten locking screw.
Note – the plastic housing of the throttle cable will fit up into the throttle cable housing.



Step 7 – Secure throttle cable using clips, as shown above.

ATTACHING BLADE

Attach blade as shown, making sure that blade is positioned on the “front side” of the base extrusion.



 Make sure bolts are tight before each use.



MACHINE ADJUSTMENTS



HANDLES

Your Shockwave™ screed has handles that can be adjusted for a customized fit.

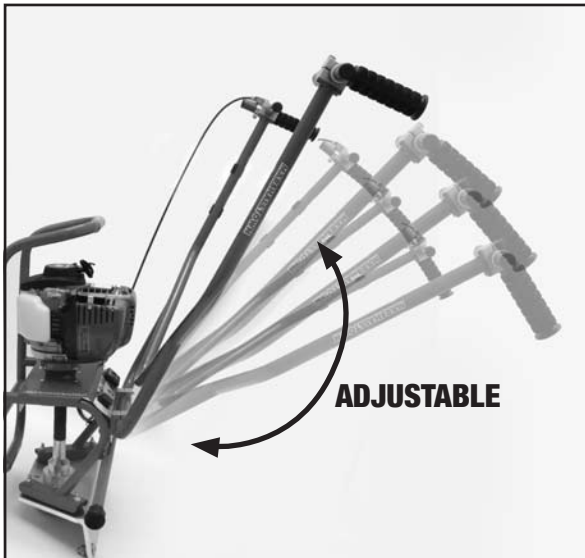

The height of the handle can be adjusted right below the motor

The grips can also be moved to accommodate wider and narrower grips, as well as flipped to the inside of the machine for an even narrower grip.

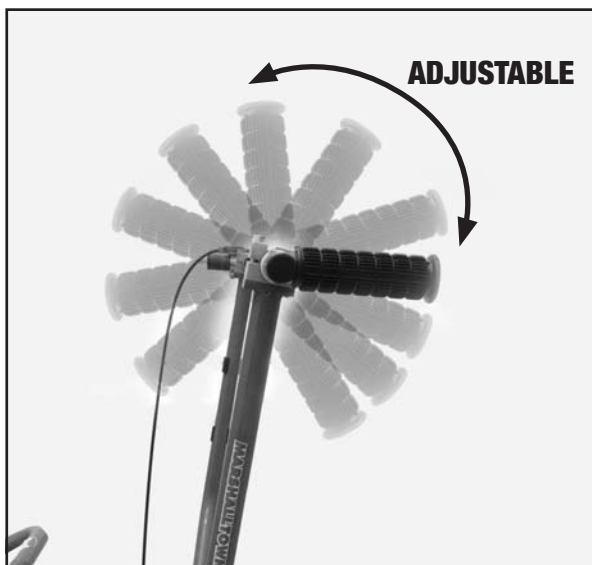

The pitch of the grips can be adjusted 360° vertically



CAUTION



Always make sure engine is stopped with switch in "OFF" position before making adjustments.

ECCENTRIC WEIGHTS

The factory weight setting will provide sufficient board vibration for most jobs. For jobs where low slump or dry concrete is being poured, the weight can easily be adjusted to allow for more vibration at lower RPM.

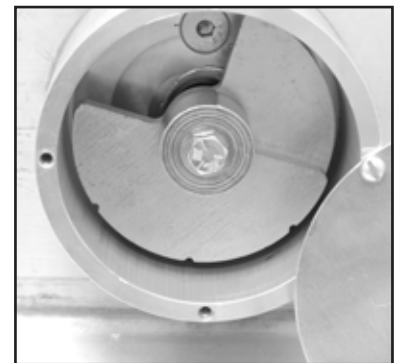

Using a slotted screwdriver remove the eccentric cover. Using a 7/16" socket, loosen the eccentric weight tightening bolt (A). You will need to wedge a screwdriver against the weight to keep it from turning while loosening bolt.

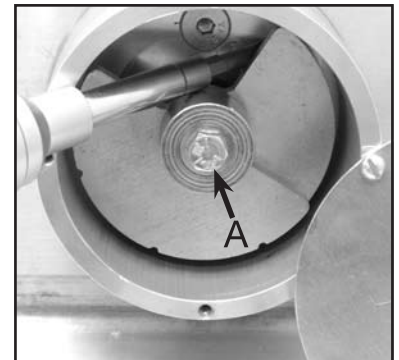

INCREASE

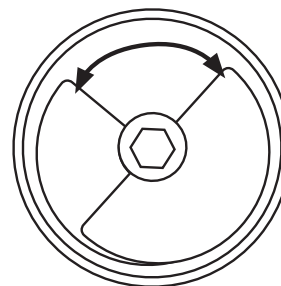

DECREASE

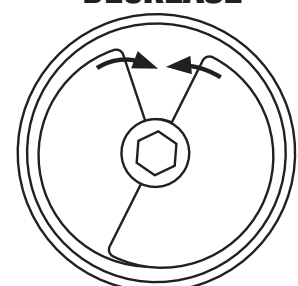

Increase vibration, increase the gap between the weights by spreading them apart.

Decrease vibration, decrease the gap between the weights. If imbalance is increased then use less engine RPM. Note: Always check and retighten the eccentric weights every 10 hours of use.

PARTS BREAKDOWN

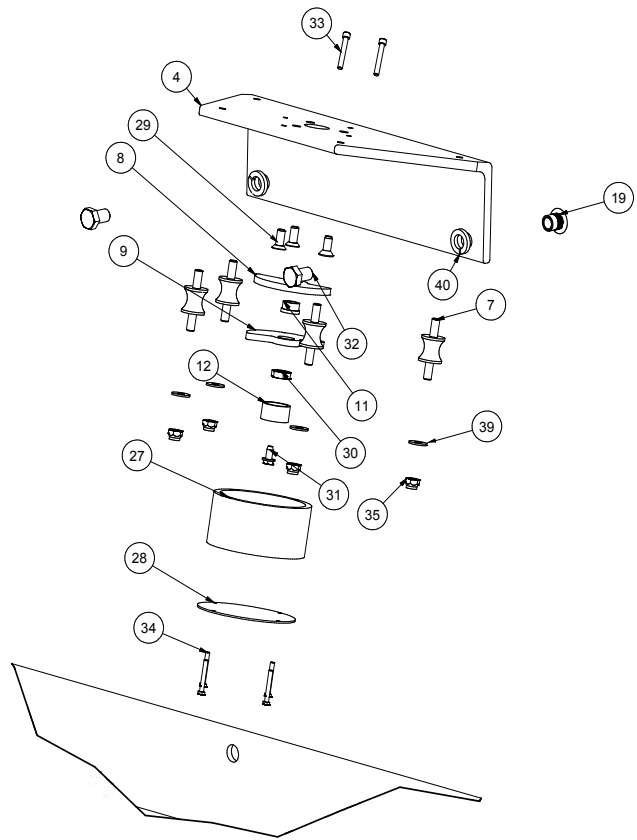

DET.	QTY.	DESCRIPTION
1	1	GX35 HONDA MOTOR
2	8	HANDLEBAR CLAMP
3	1	HANDLEBAR ASSEMBLY
4	1	BASE EXTRUSION
5	1	TACHOMETER
6	1	KILL SWITCH
7	4	VIBRATION ISOLATOR
8	1	ECCENTRIC WEIGHT #1
9	1	ECCENTRIC WEIGHT #2
10	1	ECCENTRIC SHAFT
11	1	ECCENTRIC WEIGHT BUSHING
12	1	WEIGHT ADJUSTMENT CAP
13	1	LOWER BEARING HOUSING
14	1	COUPLING DRIVE SHAFT
15	1	CLUTCH
16	1	FLEX SHAFT
17	1	HANDLEBARS, L-GRIP
18	1	HANDLEBARS, T-GRIP
19	2	BLADE ATTACHMENT NUT
20	1	BLADE
21	1	KICKSTAND END
22	1	KICKSTAND ARM
23	2	KICKSTAND EYEBOLT
24	1	KICKSTAND END CAP
25	1	SPRING
26	1	FRAME
27	1	ECCENTRIC COVER
28	1	ECCENTRIC COVER CAP
29	3	DRIVETRAIN BASE MOUNTING SCREW
30	1	ECCENTRIC WEIGHT JAM NUT
31	1	ECCENTRIC TIGHTENING CAP BOLT
32	2	BLADE ATTACHMENT BOLT
33	4	ECCENTRIC COVER MOUNTING SCREW
34	4	ECCENTRIC CAP SCREW
35	8	VIBRATION ISOLATOR NUT
36	4	WELD NUT FOR HANDLEBAR CLAMPS
37	2	TACHOMETER MOUNTING SCREW
38	2	TACHOMETER MOUNTING NUT
39	4	VIBRATION ISOLATOR NUT
40	2	BLADE ATTACHMENT LOCK WASHER
41	8	HANDLEBAR CLAMP BOLT
42	2	KICKSTAND NUT
43	2	KICKSTAND BOLT
44	1	REPLACEMENT DRIVESHAFT CORE (NOT PICTURED)
45	1	THROTTLE LEVER (FRICTION STYLE)
46	4	ENGINE MOUNTING BOLTS
47	2	HANDLEBAR GRIPS
48	1	THROTTLE CABLE
49	1	KILL SWITCH WIRING

REPLACEMENT PARTS INDEX			
EDI	PART#	DESCRIPTION	DETAILS INCLUDED
13308	13308	HANDLES WITH GRIPS	17, 18, 47
13309	13309	GRIPS	47
13310	ENG-HONDA	HONDA ENGINE	1, 46
13312	13312	THROTTLE LEVER	45
13313	13313	THROTTLE CABLE	48
13314	13314	HANDLEBARS	3
13315	13315	HANDLEBAR CLAMPS W/HARDWARE	2, 41
13316	13316	HANDLEBAR CLAMP HARDWARE ONLY	41
13317	13317	ON/OFF SWITCH W/WIRES	6, 49
13318	13318	ON/OFF SWITCH WIRES	49
13319	13319	TACHOMETER	5, 37, 38
13320	13320	ECCENTRIC COVER W/HARDWARE	27, 28, 33, 34
13321	13321	KICKSTAND	21, 22, 23, 24, 25, 42, 43
13322	13322	KICKSTAND HARDWARE	23, 25, 42, 43
13323	13323	DRIVE TRAIN	10, 13, 14, 16, 29, 44
13324	13324	CLUTCH	15, 46
13325	13325	VIBRATION DAMPENING KIT	7, 35, 39
13330	13330	ECCENTRIC WEIGHTS & HARDWARE	8, 9, 11, 12, 30, 31
13331	13331	ECCENTRIC WEIGHT HARDWARE ONLY	11, 12, 30, 31
13332	13332	MACHINE BASE	4
13333	13333	BLADE LOCKING HARDWARE	19, 32, 40
13334	13334	DRIVE SHAFT	44
13335	13335	DRIVE SHAFT HOUSING	10, 13, 14, 16
12951	12951	FRAME ONLY	26
12952	12952	ECCENTRIC COVER HARDWARE ONLY	33, 34

PARTS BREAKDOWN

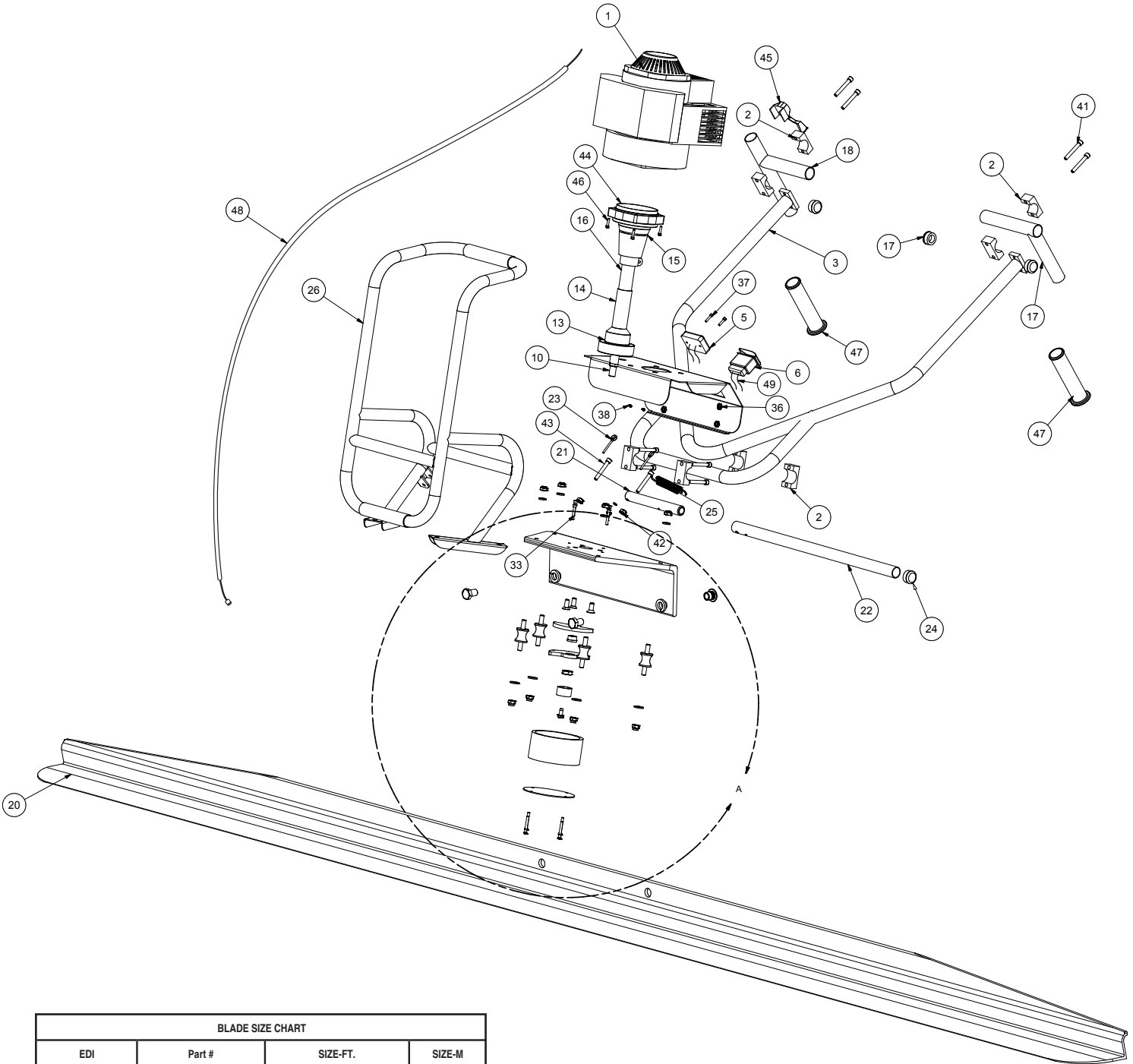

BLADE SIZE CHART

EDI	Part #	SIZE-FT.	SIZE-M
13336	SWSBLADE4	4	1.2
13281	SWSBLADE6	6	1.8
13283	SWSBLADE8	8	2.4
13284	SWSBLADE10	10	3.0
13287	SWSBLADE12	12	3.7
13290	SWSBLADE14	14	4.3
13291	SWSBLADE16	16	4.9
12950	SWSBLADE16P2	16 (2 sets of mounting holes)	4.9

HOW TO WET SCREED

SETTING ELEVATION OF SLAB

- Use grade pins (A) to set height of slab in the middle of the pour.
- Chalk line or expansion joint sets elevation around walls.
- Form boards set elevation where there are no walls.

MAKING WET PADS

1. Using hand float, make wet pads around all grade pins (A).
Note: Make sure all wet pad distances are shorter than the length of board being used.
2. Use board to stretch from wet pad to wet pad forming rows (B).
3. Once rows are formed, run screed board off of the two rows leveling the previously untouched concrete (C) in between.
NOTE: Height of concrete in area (C) must be slightly higher than wet pad rows (B) prior to striking off.

Once floated, wet pads (B) and concrete (C) will all be the same height

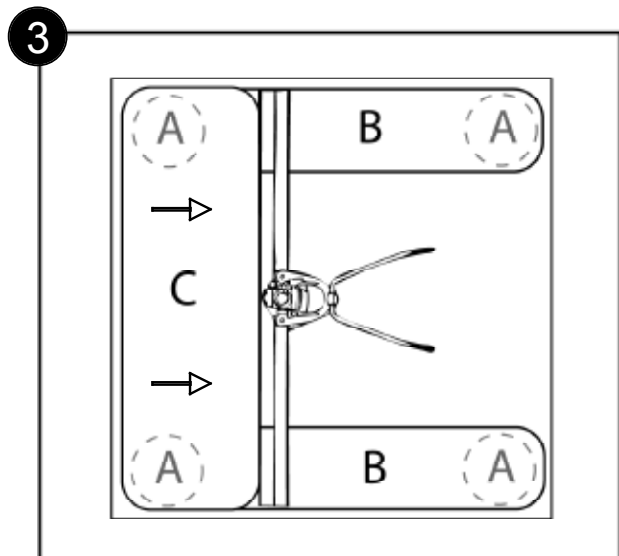
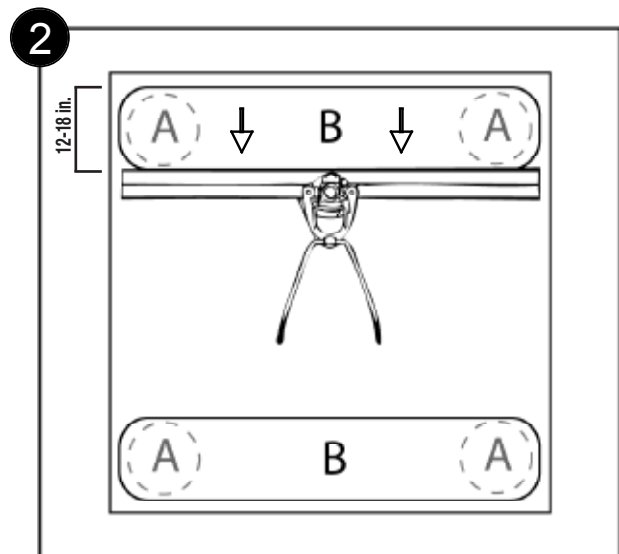
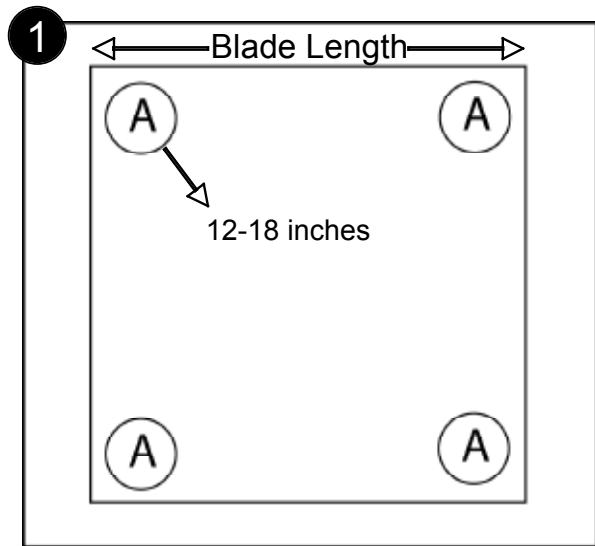

HOW TO SCREED FORM TO FORM



Length of board should overlap form boards on both sides of the pour

Keep bottom of blade as flat as possible while striking off of forms

To ensure the longest possible board life, use the lowest possible vibration setting in relationship to the slump of concrete being used.

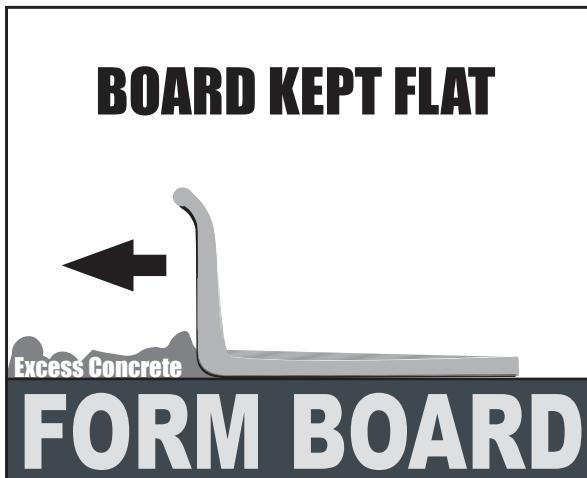
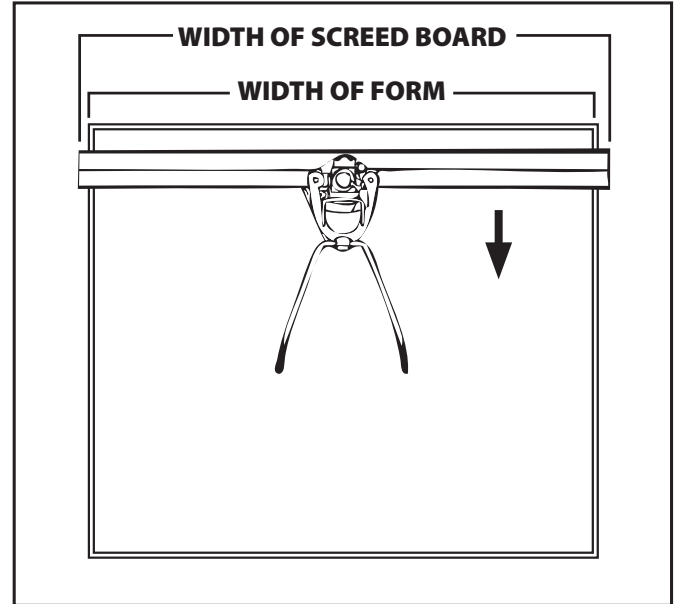

Keep bottom of blade as flat as possible while striking off of forms

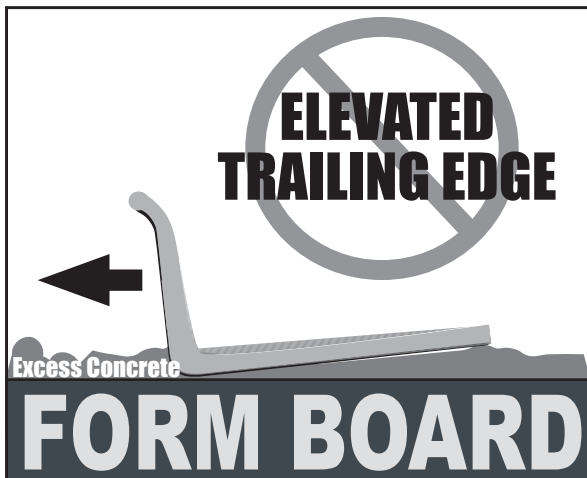

An elevated trailing edge may provide an area for concrete to build up resulting in a slab elevation that is too high

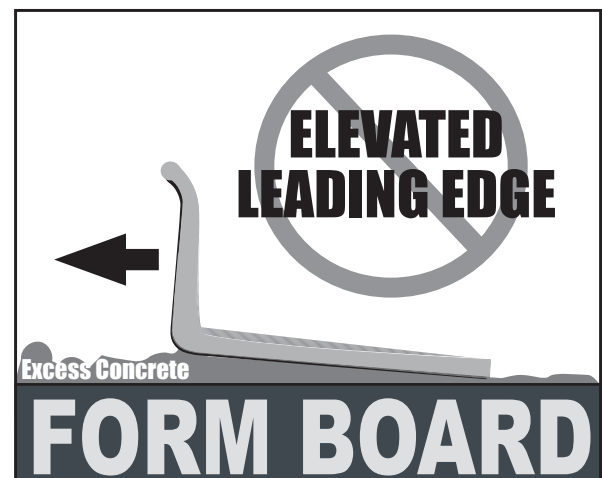

An elevated leading edge can trap rocks between the blade and forms resulting in a slab elevation that is too high



TECHNICAL DATA/CAPACITIES

Model Number	SW100H
Drive System	Flexible Shaft
Weight	33.5 lbs. (15.2 kg)
Blade Lengths	4, 6, 8, 10, 12, 14, 16' 1.2, 1.8, 2.4, 3, 3.7, 4.3, 4.9M
Blade Weight	1.85 Lb./ft. 2.75(kg/m)
Engine Type	4-stroke, overhead cam, single cylinder
Engine Make	Honda
Engine Model	GX35
Engine Horsepower	1.6 hp (1.2kW) @ 7,000 rpm
Engine Displacement	2.18 cu-in (35.8cm ³)
Spark Plug	CM5H (NGK) CMR5H (NGK)
Spark Plug Gap	0.60 - 0.70mm (0.024 - 0.028 in)
Engine Speed - idle	3,100 ± 200 rpm
Oil Type - Engine	SAE 10W-30 (refer to engine manual)
Oil Capacity - Engine	0.11 qt (3.5 oz., 0.10 L)
Fuel Type	Pump octane rating 86 or higher (refer to engine manual)
Fuel Tank Capacity	0.166 US gal (0.63 L)



CAUTION

Your Shockwave ships with a pre-measured bottle of oil (3.5 oz). Do not at anytime have more than 3.5 oz. of oil in the engine. Too much oil will foul out the spark plug resulting in an engine that is hard to start and keep running.

MAINTENANCE

The Shockwave's tachometer is a great way to keep track of maintenance schedules and track service life.



Check and retighten eccentric weights	Every 10 hours or every month
Check oil level	Before each use
Change engine oil	First month or 10 hrs. - 6 mo. or 50 hrs after
Check fuel level	Before each use
Inspect air filter	Before each use
Replace air filter	Every 25 hours or every 3 months
Spark plug - check and adjust	Every 100 hours or 1 year
Spark plug - replace	Every 300 hours or 2 years
Cooling fins	Every 50 hours
Electronic Connections	Before each use
Check Nuts and bolts	Before each use
Replace nuts and bolts	As necessary

HOW TO OPERATE



FUEL AND OIL

Make sure gas tank has plenty of 86 octane or higher gasoline. Your 4 stroke Honda engine uses straight gasoline, NEVER USE A GAS/OIL MIX. Empty entire bottle of provided Honda engine oil into crank case. 3.5 oz. is the maximum oil capacity. Always lay screed down on roll cage as shown when filling gas and oil or checking oil. NEVER OVERFILL.



STARTING

1. On a cold engine, move choke lever to CLOSED position. To restart a warm engine leave choke in OPEN position
2. Press priming bulb repeatedly until fuel can be seen in the clear-plastic fuel-return tube
3. Press On/Off Switch to the On Position.
4. Pull the starter grip lightly until you feel resistance, then pull briskly. Repeat until engine starts.
5. If the choke lever was moved to the CLOSED position to start the engine, gradually move it to the OPEN position as the engine warms up.

RESTARTING A WARM ENGINE

1. Leave the choke lever in the OPEN position.
2. If there is no fuel in the clear-plastic fuel-return tube, press priming bulb repeatedly until fuel can be seen in the tube.
3. Press On/Off Switch to the On Position
4. Pull the starter grip lightly until you feel resistance, then pull briskly. Repeat until engine starts.





OPERATING ON WET CONCRETE

Once the engine is warm and running by itself with the choke OPEN you can begin screeding concrete.



For specific instructions on Wet Screeding and Form to Form screeding please see pages 10 and 11.

1. Begin by placing concrete within your forms slightly higher than the forms themselves.
2. Place screed on top of concrete and start engine.
3. Increase engine RMP until the clutch engages causing the screed to vibrate.
4. Walking backwards, begin screeding concrete (see page 10 for Wet Screeding or Page 11 for Form to Form screeding).
5. Your throttle lever does not require constant contact, but you can adjust RMP and vibration to accommodate wet or dry concrete. Dry or low slump concrete may require more vibration to level and screed
6. Continue moving backwards while keeping concrete placed in front of the blade. The roll back feature of the blade will help keep concrete from sliding over the blade. Concrete placed too high may slide over the board! This could make the screed too hard to pull and result in a slab that is out of level.



DO NOT OVER VIBRATE CONCRETE!

The following are signs of too much vibration:

- Excessive concrete splatter
- Blade sinking below wet pads
- Ripple or “wake marks” following the blade
- Concrete easily sliding underneath form boards causing dips along the form edge

Always remember, **the less vibration the better**. Use only enough vibration to be able to comfortably pull screed backwards, leaving a smooth, level surface.

ALWAYS

- Always stop engine between loads of concrete
- Always screed while walking backwards
- Always clearly mark and be aware of all grade pins, form stakes or other trip hazards
- Always follow all safety warnings and labels of the engine manufacturer
- Always read and understand the owners manual of the engine manufacturer
- Always wear approved hearing, eye and breathing protection
- Always use form oil to coat blade or other parts susceptible to concrete build up (avoiding electrical connections) before each use
- Always properly secure screed before transporting
- Always follow recommended maintenance schedules
- Always make sure all connections and fasteners are tight before every use
- Always always make sure engine is in "OFF" position when servicing or not in use
- Always use in a well ventilated area
- Always keep Shockwave™ and engine manual handy on the job site
- Always replace parts as they become damaged or worn

NEVER

- Never operate screed without all parts and safety covers correctly attached
- Never allow children to operate
- Never operate under the influence of drugs or alcohol
- Never use screed for anything other than its intended purpose
- Never set eccentric weights to where excessive vibration occurs at low RPM (weights too far open)
- Never set eccentric weights to where it takes excessive RPM to make weights vibrate (weights too far closed)
- Never allow engine to run unattended or idle on top of wet concrete
- Never place concrete higher than the leading “curl edge” of the blade
- Never fill gas tank while engine is running
- Never start engine near spilt fuel
- Never fill gas tank, operate, or service screed near open flame
- Never use parts or blades from other manufacturers
- Never service a hot engine
- Never operate without proper training
- Never spray water or other liquid on a hot engine

PRODUCT WARRANTY



ONE YEAR LIMITED WARRANTY

Marshalltown Company (the Company) warrants, that for a period of twelve (12) months from the date of purchase, it will replace or repair, free of charge, for the original retail purchaser only, any part or parts, manufactured by the Company, found upon examination by the Company or its assigned representatives, to be defective in material or workmanship or both. All transportation charges for parts submitted for replacement or repair under this warranty must be borne by the original retail purchaser. This is the exclusive remedy under this warranty.

Failure by the original retail purchaser to install, maintain and operate said equipment in accordance with good industry practices, or failure to comply with the specific recommendations of the Company set forth in the owner's manual, shall render this warranty null and void. The Company shall not be liable for any repairs, replacements, or adjustments to the equipment or any costs for labor performed by the purchaser without the Company's prior written approval. The effects of corrosion, erosion and normal wear and tear are specifically excluded from this warranty.

THE COMPANY MAKES NO OTHER WARRANTY OR REPRESENTATION OF ANY KIND WHATSOEVER, EXPRESSED OR IMPLIED, EXCEPT THAT OF TITLE. ALL IMPLIED WARRANTIES, INCLUDING ANY WARRANTY OF MERCHANTABILITY AND FITNESS FOR PARTICULAR PURPOSE ARE HEREBY DISCLAIMED. LIABILITY FOR CONSEQUENTIAL AND INCIDENTAL DAMAGES UNDER ANY AND ALL WARRANTIES, OTHER CONTRACTS, NEGLIGENCE, OR OTHER TORTS IS EXCLUDED TO THE EXTENT EXCLUSION IS PERMITTED BY LAW.

Notwithstanding the above, any legal claim against the Company shall be barred if legal action thereon is not commenced within twenty-four (24) months from the date of purchase or delivery, whichever occurs last. This warranty constitutes the entire agreement between the Company and the original retail purchaser and no representative or agent is authorized to alter the terms of same without expressed written consent of the Company.

GARANTIE LIMITÉE D'UN AN

La Société Marshalltown Company (la Société) garantit que, pendant une période de douze (12) mois à partir de la date d'achat, elle remplacera ou réparera, gratuitement, pour l'acheteur d'origine uniquement, n'importe quelle pièce, fabriquée par la Société, jugée défectueuse par la Société ou les représentants désignés, tant au niveau des matériaux qu'à celui de la fabrication. Tous les frais de transport pour les pièces à échanger ou à réparer dans le cadre de cette garantie doivent être assurés par l'acheteur d'origine. Cela constitue le seul recours dans le cadre de cette garantie.

Par l'acheteur d'origine d'installer, d'entretenir et de faire fonctionner ledit matériel conformément aux recommandations normales pour ce type de matériel ou toute des recommandations spécifiques de la Société définies dans le manuel de l'opérateur d'entretien, se solderont par l'annulation de cette garantie. La Société ne pourra pas être tenue responsable des réparations, remplacements, ou réglages du matériel ou des coûts de main d'oeuvre de l'acheteur sans le consentement préalable par écrit de la Société. Les effets de la corrosion, de l'érosion et de l'usure normale sont spécifiquement exclus de cette garantie.

LA SOCIÉTÉ NE FOURNIT AUCUNE AUTRE GARANTIE OU REPRÉSENTATION QUELLE QU'ELLE SOIT, EXPLICITE OU IMPLICITE, SAUF POUR LE TITRE. TOUTES LES GARANTIES IMPLICITES, Y COMPRIS TOUTE GARANTIE DE COMMERCIALITÉ ET D'APTITUDE À UNE UTILISATION SPÉCIFIQUE SONT PAR CONSÉQUENT REFUSÉES. LA RESPONSABILITÉ QUANT AUX DOMMAGES INDIRECTS OU FORTUITS COUVERTS PAR TOUTES LES GARANTIES, LES AUTRES CONTRATS DE GARANTIE, LA NÉGLIGENCE OU AUTRES ACTES PRÉJUDICIALES EST EXCLUE CONFORMÉMENT AUX DISPOSITIONS D'EXCLUSION PERMISES PAR LA LOI.

Sauf pour les termes définis ci-dessus, tout recours légal contre la Société sera exclus si l'action en justice n'est pas entamée l'échéance la plus longue étant retenue dans les vingt-quatre (24) mois à partir de la date d'achat ou de livraison. Cette garantie constitue la totalité de l'accord entre la Société et l'acheteur d'origine, et aucun représentant ou agent n'est autorisé à modifier les termes sans le consentement écrit de la Société.

GARANTIA LIMITADA POR UN AÑO

Marshalltown Company (la Empresa) garantiza que durante un período de doce (12) meses a partir de la fecha de compra reemplazará o reparará, sin cargo, para el comprador minorista original, cualquier pieza o piezas fabricadas por la Empresa que, al ser estudiados por la Empresa o los representantes asignados de la Empresa, tengan defectos en el material o mano de obra o ambos. Todos los costos de transporte para las piezas enviadas para reparación o reemplazo bajo esta garantía deben ser pagados por el comprador minorista original. Este es el único recurso posible bajo esta garantía.

Si el comprador minorista original no instala, mantiene u opera dicho equipo de acuerdo con las prácticas industriales correspondientes, o no cumple con las recomendaciones específicas de la Empresa presentadas en el manual del propietario, entonces la garantía será anulada y no válida. La Empresa no será responsable de cualquier reparación, reemplazo o ajuste al equipo o cualquier costo de mano de obra realizados por el comprador sin la aprobación previa por escrito de la Empresa. Los efectos de la corrosión, erosión y desgaste normal están específicamente excluidos por esta garantía.

LA EMPRESA NO HACE NINGUNA OTRA GARANTIA NI REPRESENTACION DE NINGUN TIPO, EXPRESA O IMPLICITA, SALVO LA ANTERIOR. TODAS LAS GARANTIAS IMPLICITAS, INCLUYENDO LA GARANTIA DE COMERCIALIDAD Y APTITUD PARA UN PROPOSITO PARTICULAR ESTAN EXCLUIDAS POR ESTE MEDIO. LA RESPONSABILIDAD POR DAÑOS EMERGENTES O INCIDENTALES BAJO CUALQUIERA Y TODAS LAS GARANTIAS, OTROS CONTRATOS, NEGLIGENCIA U OTROS PERJUICIOS QUEDA EXCLUIDO EN LA MEDIDA QUE LO PERMITA LA LEY.

No obstante lo anterior, cualquier demanda legal contra la Empresa será impedida si dicha acción legal no se inicia dentro de los veinticuatro (24) meses a partir de la fecha de compra o entrega, lo que ocurra último. Esta garantía constituye todo el acuerdo entre la Empresa y el comprador minorista original y ningún representante o agente está autorizado para alterar los términos del mismo sin el consentimiento expreso por escrito de la Empresa.



MARSHALLTOWN
The Premier Line

Marshalltown, IA
Phone 800-888-0127 / 641-753-0127
Fax 800-477-6341 / 641-753-6341
www.MARSHALLTOWN.com
WS570